

CATALOGUE

Wire Termination



1. Marrette® - Wire connectors
2. Sta-Kon® - Termination products
3. Shrink-Kon® - Heat-shrinkable tubing
4. Pos-E-Kon® - Industrial connectors

Thomas & Betts is now ABB Installation Products, but our long legacy of quality products and innovation remains the same. From connectors that help wire buildings on Earth to cable ties that help put machines in space, we continue to work every day to make, market, design and sell products that provide a smarter, safer and more reliable flow of electricity, from source to socket.

Installation Products

A Canadian connection since 1928

A key business line within ABB's Electrification business, Installation Products (formerly Thomas & Betts Canada) designs, manufactures and markets essential components used to manage the connection, distribution, transmission and reliability of electrical power in industrial and commercial complexes, residential and utility applications. Wherever there is electricity, you will find our products.

Thomas & Betts established a Canadian presence in 1928 to meet the unique requirements of this market. Since being acquired by ABB in 2012, the Installation Products group has maintained its strong local presence with six manufacturing facilities, sales offices across the country and a Canadian master distribution center.

More than 80% of the products sold in Canada are manufactured in Canada.

Connect with Made in Canada products

We are proud of our distinctive Canadian presence and high-quality, locally-produced products.

Edmonton, Alberta

- T&B® cable tray systems

Pointe-Claire, Quebec (2 facilities)

- Marrette® wire connectors
- NuTek® non metallic boxes
- GFI metal fabrication

Saint-Jean-sur-Richelieu, Quebec (Iberville facility)

- Joslyn Hi-Voltage® switches and reclosers
- Microelectric® meter sockets and service entrance masts
- Superstrut® metal framing systems
- T&B® cable tray systems

The Iberville facility is the ABB global center of excellence for cable tray products.

Saint-Jean-sur-Richelieu and Saint-Remi, Quebec

- Iberville® boxes, roughing-in products and fittings
- Star Teck® teck cable fittings
- T&B® fittings

Table of contents

Section A – **Marrette - Wire connectors**

Section B – **Sta-Kon - Termination products**

Section C – **Shrink-Kon - Heat-shrinkable tubing**

Section D – **Pos-E-Kon - Industrial connectors**

Section E – **Alphanumeric index**



A

Marrette® - Wire connectors



—

A

Marrette - Wire connectors

Table of contents

Section A

History since 1914	A4
Packaging options	A5
PRO-BLU™ 933™	A6
833®	A8
XTP®	A10
Type II® winged	A12
Black® high temperature	A14
Set-screw vibration proof	A16
ACS® aluminum wiring (brown)	A18
Porcelain extreme high temperature	A20
Luminaire disconnect	A22
Wire combination reference guide	A24

History since 1914

At the turn of the twentieth century, a young Scotsman named Bill P. Marr immigrated to Ontario, Canada. After settling in the Toronto area, Marr was soon employed by the T. Eaton Company as a contractor for Ontario Hydro, where he worked as an electrician converting gas-lit homes to electrical incandescent lighting.

As part of this conversion, the accepted practice back then was a process called “solder and tape.” Typically, a mechanic would first run the wires required, then an electrician would polish the exposed conductors and twist them together. Next, the ends of the wires would be firmly joined by dipping them in a pot of molten solder, and after they cooled, the wires would then be wrapped with an insulating tape.



Over time, this process proved to be both time consuming and dangerous, as Bill Marr discovered first-hand when he inadvertently spilled a scorching solder pot while working in a customer's home. Convinced that there had to be a safer and more efficient way of joining two electrical conductors, Marr worked tirelessly in his basement shop until he finally invented the first pressure-type wire connector (a set-screw version that was the forerunner to the modern-day wire connector).

Since that day in 1914, the Marr® company became a leading manufacturer of twist-on wire connectors throughout North America. The Marrette brand so revolutionized the way branch circuits were connected that the term “marrette” has become synonymous with “wire connector” in the electrician's vocabulary.

Since being acquired in 1997 by Thomas & Betts, which was in turn acquired in 2012 by ABB, the highly respected Marrette brand name has become an integral part of the vast ABB product offering to the construction market.



Packaging options



Small formats

Model	Format	Description
P	Propak	Box of 50 or 100

Bulk pack format

Model	Format	Description
Q	Flip-pak	Container of 200 or 250
JAR	Plastic jar	Container of 200, 400 and 1,000
D	Flip-pak	Container of 500
M	Flip-pak	Container of 1,000
BP	Box	Bulk box of 1,000
BK	Flip-pak	Bulk keg of 5,000 to 10,000 (depending on model)
BAR	Barrel	Barrel of 20,000 to 45,000 (depending on model) - included: 3 unmarked Flip-paks (500 wire connectors format) with lids

Bag format

Model	Format	Description
KP	Keg pak	Resealable bag of 250 or 500

PRO-BLU 933

Designed and manufactured in Canada, the new PRO-BLU 933 wire connector was developed with the installer's needs in mind.

With an ergonomic design and a wide range of approved wire combinations, this wire connector is a perfect fit for the majority of residential and commercial applications.



External cap:

- Ergonomic wing design makes installation easy and painless, even when installing multiple wire connectors.
- Posi-Grip™ surface provides superior twisting power, even when hands are greasy or damp.
- Finger-friendly plastic for an even more comfortable grip.
- Rounded edge for safe and comfortable installation.
- Made of durable polypropylene resistant to temperatures up to 125°C (257°F).

Exclusive Live Action® variable volume spring expands to accommodate even more wires with less twisting effort compared to other wide range wire connectors.

Inner spring:

- Live Action variable volume spring expands to accommodate even more wires with less twisting effort.
- Wide range of wire combinations: #22 to #8 AWG, solid or stranded, no pre-twisting required.
- The square wire spring construction and funnel design gives a positive pressure conductor grip for solid or stranded wires.
- Approved for circuits up to 600 V and lighting fixtures and signs up to 1000 V.
- For copper conductor only.

PRO-BLU 933

Ordering information

Model	Colour	AWG wire range							
		22	20	18	16	14	12	10	8
933	Bleu	Min. 1 #22 + 1 #20, Max. 3 #10 sol							

Note: Refer to pages 35-37 for related wire combination reference guide.

Packaging options



Cat. no.	Packaging format	Quantity per package	Std. pkg. (min./mult.)
933			
933P	Propak	100	1,000 units
933BK	Flip-Pak	10,000	10,000 units
933BAR	Baril	25,000	25,000 units

Packaging options

Cat. no.	Packaging format	Quantity per package	Std. pkg. (min./mult.)
933			
833-JAR200	Plastic jar	200	200 units
933-JAR400	Plastic jar	400	400 units
933-JAR1000	Plastic jar	1,000	1,000 units

833

The Marrette 833 is an outstanding wire connector with an ergonomic wing design that can take a wide range of wire combinations from #22 to #8 AWG.

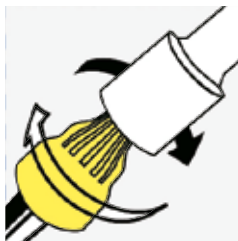
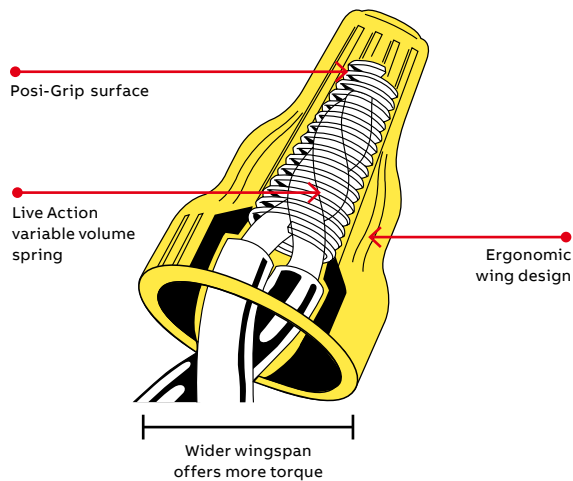

Can also be used with
1/2 in. or 13 mm nut driver.

External cap

- Ergonomic wing design gives you a comfortable grip and more torque than the competition.
- The ergonomic shape reduces finger fatigue from repetitive installations.
- The ergonomic wing shape allows excellent torque grip for your fingers as well as the option to use a standard 1/2 in. or 13 mm hex driver to help twist the wire connector.
- Made of tough durable polypropylene and 105 °C (221 °F) rated to withstand high installation pressures.
- Deep, wide throat ensures full insulation coverage.

Exclusive Live Action variable volume spring expands to accommodate even more wires with less twisting effort compared to other wide range wire connectors.

Inner spring

- Range: #22 to #8 AWG with no pre-twisting.
- The square wire spring construction and funnel design give a positive pressure conductor grip for solid or stranded wires.
- Approved for circuits up to 600 V and lighting fixtures and signs up to 1,000 V.
- For copper conductor only.
- Convenient packaging – sized right and job-site ready.

833

Ordering information

Model	Colour	AWG wire range							
		22	20	18	16	14	12	10	8
833	Yellow	Min. 2 #22 + 1 #20, Max. 3 #10							

Drivers

TOOL-WING

Driver for winged Marrette connectors

Note: Refer to pages 33-35 for related wire combination reference guide.

Packaging options



Cat. no.	Packaging format	Quantity per package	Std. pkg. (min./mult.)
833			
833P	Propak	100	1,000 units
833KP	Resealable bag	500	5,000 units
833D	Flip-pak	500	500 units
833M	Flip-pak	1,000	1,000 units
833BK	Flip-pak	10,000	10,000 units
833BAR	Barrel	25,000	25,000 units



Packaging options

Cat. no.	Packaging format	Quantity per package	Std. pkg. (min./mult.)
833			
833-JAR200	Plastic jar	200	200 units
833-JAR400	Plastic jar	400	400 units
833-JAR1000	Plastic jar	1,000	1,000 units

XTP

The Marrette XTP is a high quality, twist-on wire connector with a unique spring and cap grip design that sets it apart from the competition.

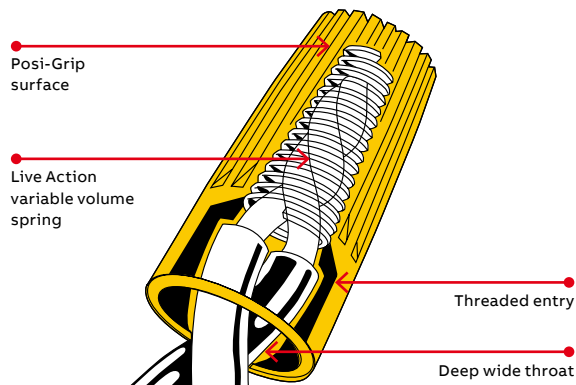

External cap

- Made of tough, durable polypropylene and 105 °C (221 °F) rated to withstand high installation pressures.
- Posi-Grip surface combines a matte finish with closely-spaced, deep grooves for superior twisting power, even when hands are greasy or damp.
- Deep, wide throat ensures full insulation coverage.
- Threaded entry helps guide large wire bundles into the spring chamber.
- Colour-coded for quick and easy size selection.

Inner spring

- Exclusive Live Action variable volume spring expands to accommodate more wires with less twisting effort compared to other connectors with a “fixed spring” design.
- Model nos. 329 and 330 have a round spring, while 331, 333 and 335 have a square wire spring construction that gives a positive conductor bite to solid or stranded wires.
- Unique copper-coated spring helps resist corrosion.
- Model nos. 329 and 330 are approved for circuits up to 300 V only. Model nos. 331, 333, 335 and 822 are approved for circuits up to 600 V, and lighting fixtures and signs up to 1000 V.
- For copper conductor only.
- Convenient packaging – sized right and job-site ready.

XTP

Ordering information

Model	Colour	AWG wire range							
		22	20	18	16	14	12	10	8
329	Grey	Min. 1 #22 + 1 #20, Max. 2 #16							
330	Blue	Min. 1 #22 + 1 #20, Max. 3 #16							
331	Orange	Min. 2 #18, Max. 3 #14							
333	Yellow	Min. 2 #18, Max. 2 #10							
335	Red	Min. 2 #14, Max. 3 #10							
822*	Blue	Min. 2 #22 + 1 #20, Max. 2 #8							

Note: Refer to pages 27-30 et 32-33 for related wire combination reference guides.

*UL not applicable.

Packaging options



Cat. no.	Packaging format	Quantity per package	Std. pkg. (min./mult.)
329			
329P	Propak	100	1,000 units
329BP	Bulk box	1,000	1,000 units
329BK	Flip-pak	10,000	10,000 units
330			
330P	Propak	100	1,000 units
330BP	Bulk box	1,000	1,000 units
330BK	Flip-pak	10,000	10,000 units
331			
331P	Propak	100	1,000 units
331D	Flip-pak	500	2,000 units
331KP*	Resealable bag	500	5,000 units
331M*	Flip-pak	1,000	1,000 units
331BK*	Flip-pak	10,000	10,000 units
331BAR*	Barrel	45,000	45,000 units
333			
333P	Propak	100	1,000 units
333KP**	Resealable bag	500	5,000 units
333D**	Flip-pak	500	500 units
333M**	Flip-pak	1,000	1,000 units
333BK**	Flip-pak	10,000	10,000 units
333BAR**	Barrel	25,000	25,000 units
335			
335P	Propak	100	1,000 units
335Q †	Flip-pak	200	800 units
335D †	Flip-pak	500	500 units
335BK	Flip-pak	7,000	7,000 units
822			
822Q	Flip-pak	200	800 units
822D*	Flip-pak	500	500 units
822BK**	Flip-pak	8,000	8,000 units
822BAR**	Barrel	20,000	20,000 units
Drivers			
TOOL 331	Plastic driver to install Model 331 (included in all)*		
TOOL 333	Plastic driver to install Model 333 and 822 (included in all packs)**		
TOOL 335	Plastic driver to install Model 335 (included in all packs) †		

Type II winged

The Marrette Type II winged wire connector is design engineered for additional twisting power to meet the high quality expectations of the electrical professional.

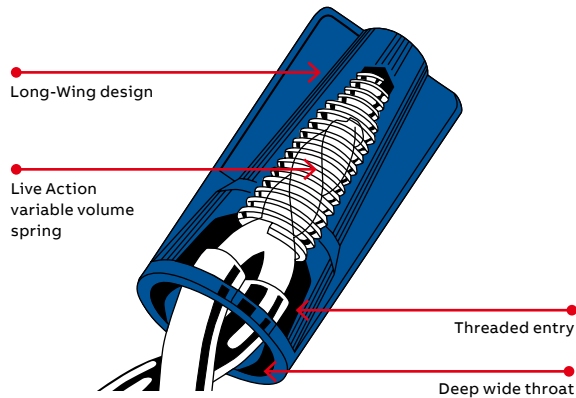

External cap

- Made of tough, durable polypropylene
- and 105 °C (221 °F) rated to withstand high installation pressures.
- Long-Wing™ design for smooth hand application. The long, offset wings with raised edges offer a full-length, “finger-friendly” gripping surface. Torque can be selectively applied exactly where you want it:
 - Top – for tight finger locations
 - Bottom – for large wire bundles
- Ribbed body surface gives additional grip, even when hands are greasy or damp.
- Deep, wide throat ensures full insulation coverage.
- Threaded entry helps guide large wire bundles into the spring chamber.
- Colour-coded for quick and easy size selection.

Inner spring

- Live Action variable volume spring expands to accommodate a wide range of wire combinations.
- Square wire construction gives a positive conductor bite to solid or stranded wires.
- Unique copper-coated spring helps resist corrosion.
- Approved for circuits up to 600 V, and lighting fixtures and signs up to 1000 V.
- For copper conductor only.
- Convenient packaging – sized right and job-site ready.

Type II winged

Ordering information

Model	Colour	AWG wire range							
		22	18	16	14	12	10	8	6
739	Blue								Min. 3 #12, Max. 2 #6

Drivers

TOOL-WING	Plastic driver to install model 739 (included in 739KP package)
-----------	---

Note: Refer to page 32 for related wire combination reference guide.

Packaging options

Cat. no.	Packaging format	Quantity per package	Std. pkg. (min./mult.)
739			
739B	Window box (retail market only*)	15/Box	10 boxes
739C	Card (retail market only*)	3/Card	20 cards
739P	Propak	50	500 units
739KP	Resealable bag	100	2,500 units
739Q	Flip-pak	250	250 units

* Retail: Order 1 each for one (1) card/box/flip-pak.

Black high temperature

The Marrette Black high temperature rating makes it the best solution for high wattage lighting fixtures and signs.

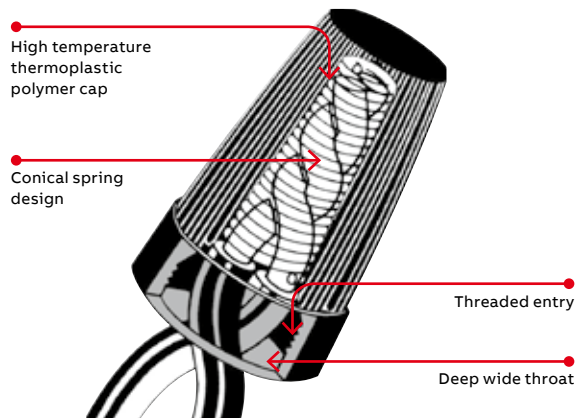

External cap

- Made of rugged, thermoplastic polymer material 150 °C (302 °F) rated.
- Large, finely ribbed, “barrel-shaped” cap – makes it easier to grip even when hands are greasy or damp.
- Deep, wide throat ensures full insulation coverage.
- Threaded entry helps guide large wire bundles right into the spring.

Inner spring

- Internal conical spring design multiplies the “twist-on” torque applied by the leverage and wedge action, to firmly crush wires into a solid joint.
- Unique copper-coated spring helps resist corrosion.
- Model no. 30 Black is approved for circuit and fixture type connections up to 300 V only.
- Model nos. 31, 33 and 35 Black are approved for circuits up to 600 V, and lighting fixtures and signs up to 1,000 V.
- For copper conductor only.
- Convenient packaging – sized right and job-site ready.

Black high temperature

Ordering information

Model	Colour	AWG wire range							
		22	20	18	16	14	12	10	8
30	Black			Min. 1 #22 + 1 #20		Max. 3 #16			
31	Black			Min. 2 #18		Max. 4 #16			
33	Black			Min. 1 #18 + 1 #14		Max. 4 #14			
35	Black							Min. 2 #14	Max. 4 #10

Note: Refer to pages 24-27 for related wire combination reference guides.

Packaging options



Cat. no.	Packaging format	Quantity per package	Std. pkg. (min./mult.)
30			
30P	Propak	100	1,000 units
30BP	Bulk box	1,000	1,000 units
30BK	Flip-pak	15,000	15,000 units
31			
31P	Propak	100	1,000 units
31D	Flip-pak	500	500 units
31M	Flip-pak	1,000	1,000 units
31BK	Flip-pak	10,000	10,000 units
33			
33P	Propak	100	1,000 units
33D	Flip-pak	500	500 units
33BK	Flip-pak	5,000	5,000 units
35			
35P	Propak	100	800 units
35Q	Flip-pak	200	800 units
35D	Flip-pak	500	500 units
35BK	Flip-pak	5,000	5,000 units

Set-screw vibration proof/visible connection

The Marrette set-screw is a two-piece, pressure-type connector featuring a solid brass insert with a screw-on insulating cap. It's the perfect choice when changing a motor, adding a circuit, conducting instrument testing or simply lashing up temporary wiring.



External cap

- Made of rugged, thermoplastic polymer material 150 °C (302 °F) rated.
- Insulator cap locks securely in place to safeguard against accidental loosening in high vibration applications..

Inner sleeve and screw

- Choice of slotted or Robertson screw-driver installation. When tightened into the insert, provides a solid pressure-type connection on all approved wire combinations.
- No need to “re-strip” wires when rewiring. Simply loosen set-screw to remove non-twisted wires.
- Brass sleeve and set-screw help resist corrosion.
- Approved for circuits up to 600 V, and lighting fixtures and signs up to 1,000 V.
- For copper conductor only.
- Convenient packaging – sized right and job-site ready.

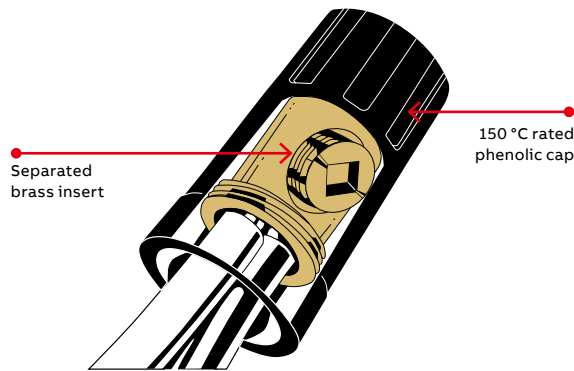

Set-screw vibration proof/visible connection

Ordering information

Model	Description	AWG wire range					
		18	16	14	12	10	8
1SHD, 1SHP	Cap and insert combination screw and brass barrel		Min. 2 #18	Max. 1 #18 + 3 #14			
1SHI	Insert screw and brass barrel only		Min. 2 #18	Max. 1 #18 + 3 #14			
2SHD, 2SHP	Cap and insert combination screw and brass barrel			Min. 2 #14	Max. 1 #12 + 2 #10		
2SHI	Insert screw and brass barrel only			Min. 2 #14	Max. 1 #12 + 2 #10		

Note: Refer to page 24 for related wire combination reference guides.

Packaging options



Cat. no.	Packaging format	Quantity per package	Std. pkg.
1SH			
1SHP	Propak	100	1,000 units
1SHD	Flip-pak	500	500 units
1SHI	Carton	100	1,000 units
2SH			
2SHP	Propak	50	500 units
2SHD	Flip-pak	500	500 units
2SHI	Carton	50	1,000 units

ACS aluminum wiring (brown)

The Marrette ACS aluminum wiring wire connector is a fixed spring, twist-on connector made of special spring wire materials and coatings to meet the rigorous standards for aluminum wire connections.



External cap

- Made of sturdy, thermoplastic valox resin 125 °C (257 °F) rated.
- Deep, wide throat ensures full insulation coverage.
- Threaded entry helps guide large wire bundles right into the spring.

Inner spring

- Made of a special bronze alloy and then plated with a thick coating of tin to satisfy the rigorous standards established for aluminum wire connections.
- Round spring design ensures that aluminum conductors and highly stranded copper wires are not scored or severed when joined.
- Approved for circuits up to 600 V, and lighting fixtures and signs up to 1,000 V.
- Approved for aluminum-to-aluminum, copper-to-copper, aluminum-to-copper (or highly stranded copper) connections.
- Convenient packaging – sized right and job-site ready.
- Not UL listed.

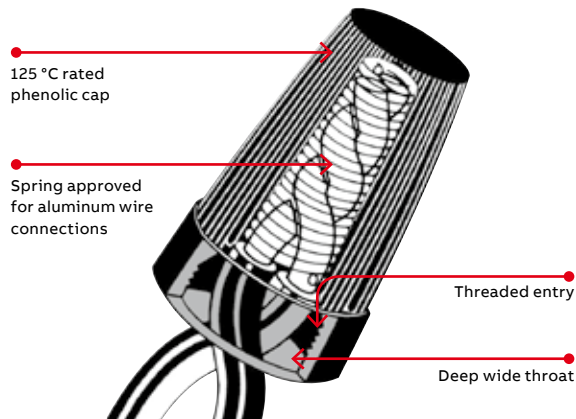

ACS aluminum wiring (brown)

Ordering information

Model	Colour	AWG wire range							
		22	20	18	16	14	12	10	8
63	Brown				Min. 1 #18 + 1 #14		Max. 4 #14		
65	Brown					Min. 2 #14		Max. 1 #12 + 2 #10	

Note: Refer to pages 30-31 for related wire combination reference guides.

Packaging options



Cat. No.	Packaging format	Quantity per package	Std. pkg. (min./mult.)
63			
63P	Propak	100	1,000 units
63D	Flip-pak	500	500 units
65			
65P	Propak	100	1,000 units
65D	Flip-pak	500	500 units

Porcelain extreme high temperature

The porcelain extreme high temperature wire connector is the solution for high temperature furnace/oven or other intense heat applications up to 645 °C (1200 °F).



Cap

- Made of porcelain – rated up to 645 °C (1200 °F).
- Closely spaced grooves for excellent twisting power.
- Deep, wide throat ensures full insulation coverage.
- Funneled entry helps wires into threaded compression compartment.
- Springless – inner surface of cap threaded to secure conductors with the same efficiency as a spring.
- Approved for circuits up to 300 V only.
- For stranded copper conductor only.

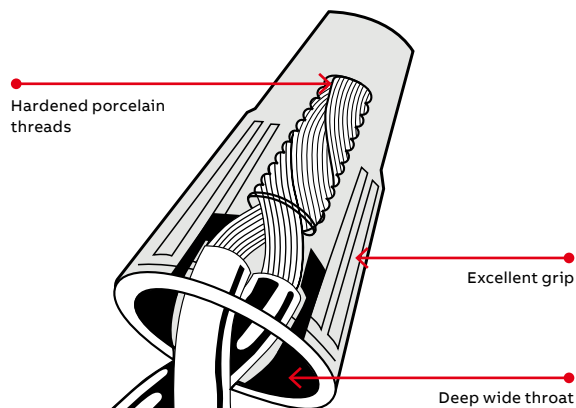

Porcelain extreme high temperature

Ordering information

Model	Colour	AWG wire range							
		22	20	18	16	14	12	10	8
10-401, 10-411, 10-421	White			Min. 2 #18, Max. 1 #18 + 2 #16					
10-405, 10-415, 10-425				Min. 2 #18, Max. 2 #18 + 2 #16					
10-407, 10-417, 10-427				Min. 2 #18, Max. 4 #16					

Note: Refer to page 24 for related wire combination reference guides.

Packaging options



Cat. no.	Packaging format	Quantity per package	Std. pkg. (min./mult.)
10-401	Box	100	100 units
10-411	Box	1,000	1,000 units
10-421	Box	5,000	5,000 units
10-405	Box	100	100 units
10-415	Box	1,000	1,000 units
10-425	Box	5,000	5,000 units
10-407	Box	100	100 units
10-417	Box	1,000	1,000 units
10-427	Box	5,000	5,000 units

Luminaire disconnect

The Marrette luminaire disconnect protects electricians servicing fluorescent lights over 150 V from electrical shock.



Suited for

- Fluorescent lighting fixtures and ballasts (OEMs)
- Electricians servicing fluorescent light fixtures
- Maintenance personnel requiring an electrical disconnect

Specifications

Housing: Polycarbonate

Contacts: Tin-plated brass

Integral leads: Insulated #18 AWG solid copper

Max. temp. rating: 105 °C (221 °F)

Flammability: UL94-V2 (V0 available on request)

Electrical rating: 4 A, 600 V

Standards: CSA certified, UL listed, NEC 410.73(G) 2005 edition compliant



Luminaire disconnect

Ordering information

Model	Description
LD2C-D	2-Pole luminaire disconnect (wire connectors not included)
LD3C-D	3-Pole luminaire disconnect (wire connectors not included)
LD2-C	2-Pole luminaire disconnect (2 x 4 wire connectors 333 /inner bag)
LD3-C	3-Pole luminaire disconnect (6 of each wire connectors 331 + 333) /inner bag)

Packaging options



Cat. no.	Packaging format		Std. pkg. (min./mult.)
Bulk			
LD2C-D	Box	Sold without wire connectors	Inner: 50 per inner bag
LD3C-D		Sold in multiple of 500	Outer: 250 per outer box Master: 500 in master box
Kits			
LD2-C	Bag	Sold with wire connectors	Inner: 2 per inner bag
LD3-C		Sold in multiple of 20	Outer: 20 per outer bag Master: 200 in master box

Wire combination reference guide

Unless otherwise specified, all combinations listed are for copper to copper connections only.

Model number	Number of cond.	AWG	+ Number of cond.	AWG	+ Number of cond.	AWG
1SH	1	18	1	14	-	-
1SH	1	18	2	14	-	-
1SH	1	18	3	14	-	-
1SH	2	18	-	-	-	-
1SH	2	18	1	14	-	-
1SH	2	18	2	14	-	-
1SH	3	18	-	-	-	-
1SH	3	18	1	14	-	-
1SH	4	18	-	-	-	-
1SH	5	18	-	-	-	-
1SH	6	18	-	-	-	-
1SH	7	18	-	-	-	-
1SH	8	18	-	-	-	-
1SH	1	16	1	14	-	-
1SH	2	16	-	-	-	-
1SH	2	16	1	14	-	-
1SH	3	16	-	-	-	-
1SH	4	16	-	-	-	-
1SH	5	16	-	-	-	-
1SH	2	14	-	-	-	-
1SH	3	14	-	-	-	-
1SH	2	12	-	-	-	-
10401	1	18	2	16	-	-
10401	1	18	1	14	-	-
10401	2	18	-	-	-	-
10401	2	18	1	16	-	-
10401	3	18	-	-	-	-
10401	4	18	-	-	-	-
10401	2	16	-	-	-	-
10405	1	18	1	16	-	-
10405	1	18	2	16	-	-
10405	1	18	1	14	-	-
10405	2	18	-	-	-	-
10405	2	18	1	16	-	-
10405	2	18	2	16	-	-
10405	2	18	1	14	-	-
10405	3	18	-	-	-	-
10405	3	18	1	16	-	-
10405	4	18	-	-	-	-
10405	1	16	1	14	-	-
10405	2	16	-	-	-	-
10405	3	16	-	-	-	-
10407	1	18	1	16	-	-
10407	1	18	2	16	-	-

Model number	Number of cond.	AWG	+ Number of cond.	AWG	+ Number of cond.	AWG
10407	1	18	3	16	-	-
10407	1	18	1	14	-	-
10407	1	18	2	14	-	-
10407	1	18	1	12	-	-
10407	2	18	-	-	-	-
10407	2	18	1	16	-	-
10407	2	18	1	14	-	-
10407	3	18	-	-	-	-
10407	3	18	1	16	-	-
10407	3	18	1	14	-	-
10407	4	18	-	-	-	-
10407	5	18	-	-	-	-
10407	1	16	1	14	-	-
10407	1	16	1	12	-	-
10407	2	16	1	14	-	-
10407	2	16	-	-	-	-
10407	3	16	-	-	-	-
10407	4	16	-	-	-	-
10407	2	14	-	-	-	-
2SH	1	16	2	14	-	-
2SH	2	16	1	14	-	-
2SH	2	16	2	14	-	-
2SH	3	16	1	14	-	-
2SH	2	10	-	-	-	-
30	1	22	1	20	-	-
30	1	22	1	20	1	18
30	1	22	1	20	1	16
30	1	22	3	20	-	-
30	1	22	4	20	-	-
30	1	22	1	18	-	-
30	1	22	2	18	-	-
30	1	22	3	18	-	-
30	1	22	4	18	-	-
30	1	22	1	16	-	-
30	1	22	2	16	-	-
30	1	22	1	14	-	-
30	2	22	1	20	-	-
30	2	22	2	20	-	-
30	2	22	3	20	-	-
30	2	22	4	20	-	-
30	2	22	1	18	-	-
30	2	22	2	18	-	-
30	2	22	3	18	-	-
30	2	22	1	16	-	-
30	2	22	2	16	-	-
30	2	22	1	14	-	-

Wire combination reference guide

Model number	Number of cond.	AWG	+ Number of cond.	AWG	+ Number of cond.	AWG
30	3	22	-	-	-	-
30	3	22	1	20	-	-
30	3	22	2	20	-	-
30	3	22	1	18	-	-
30	3	22	1	16	-	-
30	3	22	2	16	-	-
30	3	22	1	14	-	-
30	4	22	-	-	-	-
30	4	22	1	20	-	-
30	4	22	1	18	-	-
30	4	22	1	16	-	-
30	4	22	1	14	-	-
30	5	22	-	-	-	-
30	5	22	1	18	-	-
30	1	20	1	18	-	-
30	1	20	2	18	-	-
30	1	20	3	18	-	-
30	1	20	1	16	-	-
30	1	20	2	16	-	-
30	1	20	1	14	-	-
30	2	20	-	-	-	-
30	2	20	1	18	-	-
30	2	20	3	18	-	-
30	2	20	1	16	-	-
30	2	20	2	16	-	-
30	2	20	1	14	-	-
30	3	20	-	-	-	-
30	3	20	1	18	-	-
30	3	20	1	16	-	-
30	3	20	1	14	-	-
30	4	20	-	-	-	-
30	4	20	1	18	-	-
30	4	20	1	16	-	-
30	5	20	-	-	-	-
30	1	18	1	16	-	-
30	1	18	2	16	-	-
30	1	18	1	14	-	-
30	2	18	-	-	-	-
30	3	18	-	-	-	-
30	4	18	-	-	-	-
30	1	16	1	14	-	-
30	2	16	-	-	-	-
30	3	16	-	-	-	-
31	1	18	1	16	-	-
31	1	18	2	16	-	-
31	1	18	3	16	-	-
31	1	18	1	14	-	-

Model number	Number of cond.	AWG	+ Number of cond.	AWG	+ Number of cond.	AWG
31	1	18	2	14	-	-
31	2	18	-	-	-	-
31	2	18	1	16	-	-
31	2	18	2	16	-	-
31	2	18	1	14	-	-
31	3	18	-	-	-	-
31	3	18	1	16	-	-
31	3	18	2	16	-	-
31	3	18	1	14	-	-
31	4	18	-	-	-	-
31	4	18	1	16	-	-
31	5	18	-	-	-	-
31	1	16	1	14	-	-
31	2	16	-	-	-	-
31	2	16	1	14	-	-
31	3	16	-	-	-	-
31	4	16	-	-	-	-
31	2	14	-	-	-	-
33	1	18	1	14	-	-
33	1	18	2	14	-	-
33	1	18	3	14	-	-
33	1	18	1	12	-	-
33	2	18	1	16	-	-
33	2	18	2	16	-	-
33	2	18	3	16	-	-
33	2	18	4	16	-	-
33	2	18	1	14	-	-
33	2	18	2	14	-	-
33	2	18	1	12	-	-
33	3	18	1	16	-	-
33	3	18	2	16	-	-
33	3	18	1	14	-	-
33	3	18	2	14	-	-
33	3	18	1	12	-	-
33	4	18	1	16	-	-
33	4	18	2	16	-	-
33	4	18	1	14	-	-
33	4	18	1	12	-	-
33	5	18	-	-	-	-
33	1	16	1	14	-	-
33	1	16	2	14	-	-
33	1	16	3	14	-	-
33	1	16	1	12	-	-
33	2	16	1	14	-	-
33	2	16	2	14	-	-
33	2	16	1	12	-	-
33	3	16	-	-	-	-

Wire combination reference guide

Model number	Number of cond.	AWG	+ Number of cond.	AWG	+ Number of cond.	AWG
33	3	16	1	14	-	-
33	3	16	2	14	-	-
33	3	16	1	12	-	-
33	4	16	-	-	-	-
33	4	16	1	14	-	-
33	5	16	-	-	-	-
33	1	14	1	12	-	-
33	2	14	-	-	-	-
33	2	14	1	12	-	-
33	3	14	-	-	-	-
33	4	14	-	-	-	-
33	2	12	-	-	-	-
35	1	18	4	14	-	-
35	1	18	5	14	-	-
35	1	18	6	14	-	-
35	1	18	2	12	-	-
35	1	18	3	12	-	-
35	1	18	1	10	-	-
35	1	18	2	10	-	-
35	1	18	3	10	-	-
35	2	18	4	16	-	-
35	2	18	4	14	-	-
35	2	18	6	14	-	-
35	2	18	2	12	-	-
35	2	18	3	12	-	-
35	2	18	1	10	-	-
35	2	18	2	10	-	-
35	3	18	4	14	-	-
35	3	18	2	12	-	-
35	3	18	3	12	-	-
35	3	18	1	10	-	-
35	3	18	2	10	-	-
35	4	18	2	12	-	-
35	4	18	1	10	-	-
35	4	18	2	10	-	-
35	5	18	2	12	-	-
35	5	18	1	10	-	-
35	6	18	1	10	-	-
35	6	18	1	18	1	12
35	1	16	4	14	-	-
35	1	16	5	14	-	-
35	1	16	6	14	-	-
35	1	16	2	12	-	-
35	1	16	3	12	-	-
35	1	16	1	10	-	-
35	1	16	2	10	-	-
35	2	16	4	14	-	-

Model number	Number of cond.	AWG	+ Number of cond.	AWG	+ Number of cond.	AWG
35	2	16	6	14	-	-
35	2	16	2	12	-	-
35	2	16	3	12	-	-
35	2	16	1	10	-	-
35	2	16	2	10	-	-
35	3	16	4	14	-	-
35	3	16	2	12	-	-
35	3	16	3	12	-	-
35	3	16	1	10	-	-
35	3	16	2	10	-	-
35	4	16	2	12	-	-
35	4	16	1	10	-	-
35	5	16	-	-	-	-
35	5	16	2	12	-	-
35	5	16	1	10	-	-
35	6	16	-	-	-	-
35	6	16	1	10	-	-
35	6	16	1	16	-	-
35	6	16	2	16	-	-
35	1	14	1	12	-	-
35	1	14	2	12	-	-
35	1	14	3	12	-	-
35	1	14	4	12	-	-
35	1	14	1	10	-	-
35	1	14	2	10	-	-
35	1	14	3	10	-	-
35	1	14	1	8	-	-
35	2	14	-	-	-	-
35	2	14	1	12	-	-
35	2	14	2	12	-	-
35	2	14	3	12	-	-
35	2	14	1	10	-	-
35	2	14	2	10	-	-
35	2	14	1	8	-	-
35	3	14	-	-	-	-
35	3	14	1	12	-	-
35	3	14	2	12	-	-
35	3	14	1	10	-	-
35	3	14	2	10	-	-
35	3	14	1	8	-	-
35	4	14	-	-	-	-
35	4	14	1	12	-	-
35	4	14	1	10	-	-
35	5	14	-	-	-	-
35	5	14	1	12	-	-
35	6	14	-	-	-	-
35	1	12	1	10	-	-
35	1	12	2	10	-	-

Wire combination reference guide

Model number	Number of cond.	AWG	+ Number of cond.	AWG	+ Number of cond.	AWG
35	1	12	3	10	-	-
35	1	12	1	8	-	-
35	2	12	-	-	-	-
35	2	12	1	10	-	-
35	2	12	2	10	-	-
35	2	12	1	8	-	-
35	3	12	-	-	-	-
35	3	12	1	10	-	-
35	3	12	1	8	-	-
35	4	12	-	-	-	-
35	4	12	1	10	-	-
35	5	12	-	-	-	-
35	1	10	1	8	-	-
35	2	10	-	-	-	-
35	2	10	1	8	-	-
35	3	10	-	-	-	-
35	4	10	-	-	-	-
35	2	8	-	-	-	-
329	1	22	1	20	-	-
329	1	22	2	20	-	-
329	1	22	3	20	-	-
329	1	22	1	20	1	18
329	1	22	1	20	1	16
329	1	22	1	18	-	-
329	1	22	2	18	-	-
329	1	22	1	16	-	-
329	2	22	1	20	-	-
329	2	22	2	20	-	-
329	2	22	3	20	-	-
329	2	22	1	18	-	-
329	2	22	1	16	-	-
329	3	22	-	-	-	-
329	3	22	1	20	-	-
329	3	22	2	20	-	-
329	3	22	1	18	-	-
329	4	22	-	-	-	-
329	4	22	1	20	-	-
329	4	22	1	18	-	-
329	5	22	-	-	-	-
329	1	20	1	18	-	-
329	1	20	2	18	-	-
329	1	20	1	16	-	-
329	2	20	-	-	-	-
329	2	20	1	18	-	-
329	3	20	-	-	-	-
329	4	20	-	-	-	-
329	1	18	1	16	-	-

Model number	Number of cond.	AWG	+ Number of cond.	AWG	+ Number of cond.	AWG
330	1	22	1	20	-	-
330	1	22	1	20	1	18
330	1	22	1	20	1	16
330	1	22	3	20	-	-
330	1	22	4	20	-	-
330	1	22	1	18	-	-
330	1	22	2	18	-	-
330	1	22	3	18	-	-
330	1	22	4	18	-	-
330	1	22	1	16	-	-
330	1	22	2	16	-	-
330	1	22	1	14	-	-
330	2	22	1	20	-	-
330	2	22	2	20	-	-
330	2	22	3	20	-	-
330	2	22	4	20	-	-
330	2	22	1	18	-	-
330	2	22	2	18	-	-
330	2	22	3	18	-	-
330	2	22	1	16	-	-
330	2	22	2	16	-	-
330	2	22	1	14	-	-
330	3	22	-	-	-	-
330	3	22	1	20	-	-
330	3	22	2	20	-	-
330	3	22	1	18	-	-
330	3	22	1	16	-	-
330	3	22	2	16	-	-
330	3	22	1	14	-	-
330	4	22	-	-	-	-
330	4	22	1	20	-	-
330	4	22	1	18	-	-
330	4	22	1	16	-	-
330	4	22	1	14	-	-
330	5	22	-	-	-	-
330	5	22	1	18	-	-
330	1	20	1	18	-	-
330	1	20	2	18	-	-
330	1	20	3	18	-	-
330	1	20	1	16	-	-
330	1	20	2	16	-	-
330	1	20	1	14	-	-
330	2	20	-	-	-	-
330	2	20	1	18	-	-
330	2	20	3	18	-	-
330	2	20	1	16	-	-
330	2	20	2	16	-	-

Wire combination reference guide

Model number	Number of cond.	AWG	+ Number of cond.	AWG	+ Number of cond.	AWG
330	2	20	1	14	-	-
330	3	20	-	-	-	-
330	3	20	1	18	-	-
330	3	20	1	16	-	-
330	3	20	1	14	-	-
330	4	20	-	-	-	-
330	4	20	1	18	-	-
330	4	20	1	16	-	-
330	5	20	-	-	-	-
330	1	18	1	16	-	-
330	1	18	2	16	-	-
330	1	18	1	14	-	-
330	2	18	-	-	-	-
330	3	18	-	-	-	-
330	4	18	-	-	-	-
330	1	16	1	14	-	-
330	2	16	-	-	-	-
330	3	16	-	-	-	-
331	1	18	1	16	-	-
331	1	18	2	16	-	-
331	1	18	3	16	-	-
331	1	18	1	14	-	-
331	1	18	2	14	-	-
331	2	18	-	-	-	-
331	2	18	1	16	-	-
331	2	18	2	16	-	-
331	2	18	2	14	-	-
331	3	18	-	-	-	-
331	3	18	1	14	-	-
331	3	18	1	16	-	-
331	3	18	2	16	-	-
331	4	18	-	-	-	-
331	5	18	-	-	-	-
331	1	16	1	14	-	-
331	1	16	2	14	-	-
331	2	16	-	-	-	-
331	2	16	1	14	-	-
331	3	16	-	-	-	-
331	3	16	1	14	-	-
331	4	16	-	-	-	-
331	2	14	-	-	-	-
331	3	14	-	-	-	-
333	1	18	2	14	-	-
333	1	18	3	14	-	-
333	1	18	4	14	-	-
333	1	18	1	12	-	-

Model number	Number of cond.	AWG	+ Number of cond.	AWG	+ Number of cond.	AWG
333	1	18	2	12	-	-
333	2	18	-	-	-	-
333	2	18	2	16	-	-
333	2	18	3	16	-	-
333	2	18	4	16	-	-
333	2	18	1	14	-	-
333	2	18	2	14	-	-
333	2	18	1	12	-	-
333	3	18	2	16	-	-
333	3	18	1	14	-	-
333	3	18	2	14	-	-
333	3	18	1	12	-	-
333	4	18	2	16	-	-
333	4	18	1	14	-	-
333	5	18	-	-	-	-
333	6	18	-	-	-	-
333	1	16	2	14	-	-
333	1	16	3	14	-	-
333	1	16	1	12	-	-
333	1	16	2	12	-	-
333	2	16	1	14	-	-
333	2	16	2	14	-	-
333	2	16	1	12	-	-
333	2	16	2	12	-	-
333	3	16	-	-	-	-
333	3	16	1	14	-	-
333	3	16	2	14	-	-
333	3	16	1	12	-	-
333	4	16	-	-	-	-
333	4	16	1	14	-	-
333	5	16	-	-	-	-
333	1	14	1	12	-	-
333	1	14	2	12	-	-
333	1	14	1	10	-	-
333	2	14	-	-	-	-
333	2	14	1	12	-	-
333	2	14	1	10	-	-
333	3	14	-	-	-	-
333	4	14	-	-	-	-
333	1	12	1	10	-	-
333	2	12	-	-	-	-
333	2	10	-	-	-	-
335	1	22	2	18	-	-
335	2	22	2	16	-	-
335	2	22	3	16	-	-
335	3	22	1	16	-	-
335	4	22	1	16	-	-

Wire combination reference guide

Model number	Number of cond.	AWG	+ Number of cond.	AWG	+ Number of cond.	AWG
335	1	20	2	18	-	-
335	1	20	3	18	-	-
335	1	20	4	18	-	-
335	2	20	2	18	-	-
335	2	20	3	18	-	-
335	2	20	1	16	-	-
335	2	20	2	16	-	-
335	2	20	3	16	-	-
335	3	20	1	18	-	-
335	3	20	2	18	-	-
335	3	20	1	16	-	-
335	4	20	-	-	-	-
335	4	20	1	18	-	-
335	4	20	1	16	-	-
335	5	20	-	-	-	-
335	1	18	2	16	-	-
335	1	18	3	16	-	-
335	1	18	4	16	-	-
335	1	18	5	16	-	-
335	1	18	2	14	-	-
335	1	18	3	14	-	-
335	1	18	4	14	-	-
335	1	18	5	14	-	-
335	1	18	1	12	-	-
335	1	18	2	12	-	-
335	1	18	3	12	-	-
335	2	18	1	16	-	-
335	2	18	2	16	-	-
335	2	18	3	16	-	-
335	2	18	4	16	-	-
335	2	18	1	14	-	-
335	2	18	2	14	-	-
335	2	18	3	14	-	-
335	2	18	4	14	-	-
335	2	18	1	12	-	-
335	2	18	2	12	-	-
335	2	18	3	12	-	-
335	3	18	-	-	-	-
335	3	18	1	16	-	-
335	3	18	2	16	-	-
335	3	18	3	16	-	-
335	3	18	1	14	-	-
335	3	18	2	14	-	-
335	3	18	3	14	-	-
335	3	18	1	12	-	-
335	3	18	2	12	-	-
335	3	18	3	12	-	-
335	4	18	-	-	-	-

Model number	Number of cond.	AWG	+ Number of cond.	AWG	+ Number of cond.	AWG
335	4	18	1	16	-	-
335	4	18	2	16	-	-
335	4	18	1	14	-	-
335	4	18	2	14	-	-
335	4	18	1	12	-	-
335	4	18	2	12	-	-
335	5	18	-	-	-	-
335	5	18	1	12	-	-
335	5	18	2	12	-	-
335	6	18	-	-	-	-
335	1	16	2	14	-	-
335	1	16	3	14	-	-
335	1	16	4	14	-	-
335	1	16	2	12	-	-
335	1	16	3	12	-	-
335	1	16	4	12	-	-
335	1	16	2	10	-	-
335	2	16	-	-	-	-
335	2	16	1	14	-	-
335	2	16	2	14	-	-
335	2	16	3	14	-	-
335	2	16	1	12	-	-
335	2	16	2	12	-	-
335	2	16	3	12	-	-
335	2	16	1	10	-	-
335	2	16	2	10	-	-
335	3	16	-	-	-	-
335	3	16	1	14	-	-
335	3	16	2	14	-	-
335	3	16	3	14	-	-
335	3	16	1	12	-	-
335	3	16	2	12	-	-
335	3	16	3	12	-	-
335	4	16	-	-	-	-
335	4	16	1	14	-	-
335	4	16	1	12	-	-
335	4	16	2	12	-	-
335	5	16	-	-	-	-
335	5	16	2	12	-	-
335	6	16	-	-	-	-
335	1	14	1	12	-	-
335	1	14	2	12	-	-
335	1	14	3	12	-	-
335	1	14	4	12	-	-
335	1	14	1	10	-	-
335	1	14	2	10	-	-
335	2	14	-	-	-	-
335	2	14	1	12	-	-

Wire combination reference guide

Model number	Number of cond.	AWG	+ Number of cond.	AWG	+ Number of cond.	AWG
335	2	14	2	12	-	-
335	2	14	3	12	-	-
335	2	14	1	10	-	-
335	2	14	2	10	-	-
335	3	14	-	-	-	-
335	3	14	1	12	-	-
335	3	14	2	12	-	-
335	3	14	1	10	-	-
335	4	14	-	-	-	-
335	4	14	1	12	-	-
335	4	14	2	12	-	-
335	5	14	-	-	-	-
335	5	14	1	12	-	-
335	5	14	1	10	-	-
335	1	12	1	10	-	-
335	1	12	2	10	-	-
335	2	12	-	-	-	-
335	2	12	1	10	-	-
335	3	12	-	-	-	-
335	3	12	1	10	-	-
335	4	12	-	-	-	-
335	3	10	-	-	-	-
Copper-copper						
63	1	18	1	14	-	-
63	1	18	2	14	-	-
63	1	18	3	14	-	-
63	1	18	1	12	-	-
63	1	18	2	12	-	-
63	2	18	1	16	-	-
63	2	18	2	16	-	-
63	2	18	3	16	-	-
63	2	18	1	14	-	-
63	2	18	2	14	-	-
63	2	18	1	12	-	-
63	3	18	1	16	-	-
63	3	18	2	16	-	-
63	3	18	1	14	-	-
63	3	18	2	14	-	-
63	3	18	1	12	-	-
63	4	18	1	16	-	-
63	4	18	2	16	-	-
63	4	18	1	14	-	-
63	5	18	-	-	-	-
63	6	18	-	-	-	-
63	1	16	1	14	-	-
63	1	16	2	14	-	-
63	1	16	3	14	-	-

Model number	Number of cond.	AWG	+ Number of cond.	AWG	+ Number of cond.	AWG
63	1	16	1	12	-	-
63	1	16	2	12	-	-
63	2	16	1	14	-	-
63	2	16	2	14	-	-
63	2	16	1	12	-	-
63	3	16	-	-	-	-
63	3	16	1	14	-	-
63	3	16	1	12	-	-
63	4	16	-	-	-	-
63	5	16	-	-	-	-
63	1	14	1	12	-	-
63	1	14	1	10	-	-
63	2	14	-	-	-	-
63	2	14	1	12	-	-
63	3	14	-	-	-	-
63	4	14	-	-	-	-
63	2	12	-	-	-	-
Copper-aluminum						
63	1	18	1	12	-	-
63	2	18	1	12	-	-
63	3	18	1	12	-	-
63	1	16	1	12	-	-
63	2	16	1	12	-	-
63	3	16	1	12	-	-
63	1	14	1	12	-	-
63	2	14*	1	12	-	-
63	1	12*	1	12	-	-
Aluminum-aluminum						
63	2	12	-	-	-	-
Copper-copper						
65	1	18	4	14	-	-
65	1	18	5	14	-	-
65	1	18	6	14	-	-
65	1	18	2	12	-	-
65	1	18	3	12	-	-
65	1	18	1	10	-	-
65	1	18	2	10	-	-
65	2	18	4	16	-	-
65	2	18	4	14	-	-
65	2	18	2	12	-	-
65	2	18	3	12	-	-
65	2	18	1	10	-	-
65	2	18	2	10	-	-
65	3	18	4	14	-	-
65	3	18	2	12	-	-

* Solid only

Wire combination reference guide

Model number	Number of cond.	AWG	+ Number of cond.	AWG	+ Number of cond.	AWG
65	3	18	3	12	-	-
65	3	18	1	10	-	-
65	3	18	2	10	-	-
65	4	18	2	12	-	-
65	4	18	1	10	-	-
65	4	18	2	10	-	-
65	5	18	2	12	-	-
65	5	18	1	10	-	-
65	6	18	1	10	-	-
65	1	16	4	14	-	-
65	1	16	5	14	-	-
65	1	16	6	14	-	-
65	1	16	2	12	-	-
65	1	16	3	12	-	-
65	1	16	1	10	-	-
65	1	16	2	10	-	-
65	2	16	4	14	-	-
65	2	16	2	12	-	-
65	2	16	3	12	-	-
65	2	16	1	10	-	-
65	2	16	2	10	-	-
65	3	16	4	14	-	-
65	3	16	2	12	-	-
65	3	16	3	12	-	-
65	3	16	1	10	-	-
65	4	16	2	12	-	-
65	4	16	1	10	-	-
65	5	16	-	-	-	-
65	5	16	2	12	-	-
65	5	16	1	10	-	-
65	6	16	-	-	-	-
65	6	16	1	10	-	-
65	7	16	-	-	-	-
65	1	14	1	12	-	-
65	1	14	2	12	-	-
65	1	14	3	12	-	-
65	1	14	1	10	-	-
65	1	14	2	10	-	-
65	2	14	-	-	-	-
65	2	14	1	12	-	-
65	2	14	2	12	-	-
65	2	14	1	10	-	-
65	3	14	-	-	-	-
65	3	14	1	12	-	-
65	3	14	2	12	-	-
65	3	14	1	10	-	-
65	4	14	-	-	-	-
65	4	14	1	12	-	-

Model number	Number of cond.	AWG	+ Number of cond.	AWG	+ Number of cond.	AWG
65	5	14	-	-	-	-
65	5	14	1	12	-	-
65	6	14	-	-	-	-
65	1	12	1	10	-	-
65	1	12	2	10	-	-
65	2	12	-	-	-	-
65	2	12	1	10	-	-
65	3	12	-	-	-	-
65	4	12	-	-	-	-
Copper-aluminum						
65	1	18	3	12	-	-
65	1	18	2	10	-	-
65	2	18	3	12	-	-
65	2	18	2	10	-	-
65	3	18	3	12	-	-
65	3	18	2	10	-	-
65	4	18	2	10	-	-
65	1	16	3	12	-	-
65	1	16	2	10	-	-
65	2	16	3	12	-	-
65	2	16	2	10	-	-
65	3	16	3	12	-	-
65	6	16	1	10	-	-
65	1	14	1	12	-	-
65	1	14	2	12	-	-
65	1	14*	3	12	-	-
65	1	14*	1	10	-	-
65	1	14	2	10	-	-
65	2	14*	1	12	-	-
65	2	14*	2	12	-	-
65	2	14*	1	10	-	-
65	3	14*	1	12	-	-
65	3	14*	2	12	-	-
65	3	14*	1	10	-	-
65	4	14*	1	12	-	-
65	5	14*	1	12	-	-
65	1	12	1	12	-	-
65	1	12	2	12	-	-
65	1	12	1	10	-	-
65	1	12	2	10	-	-
65	2	12	1	10	-	-
Aluminum-aluminum						
65	1	12*	1	10	-	-
65	1	12	2	10	-	-
65	2	12	-	-	-	-
65	2	12	1	10	-	-

* Solid only

Wire combination reference guide

Model number	Number of cond.	AWG	+ Number of cond.	AWG	+ Number of cond.	AWG
65	3	12	-	-	-	-
65	4	12	-	-	-	-
65	2	10	-	-	-	-
739	1	14	3	12	-	-
739	1	14	2	10	-	-
739	1	14	3	10	-	-
739	1	14	2	8	-	-
739	2	14	2	12	-	-
739	2	14	3	12	-	-
739	2	14	2	10	-	-
739	2	14	3	10	-	-
739	2	14	2	8	-	-
739	3	14	2	12	-	-
739	3	14	3	12	-	-
739	3	14	1	10	-	-
739	3	14	2	10	-	-
739	3	14	3	10	-	-
739	3	14	2	8	-	-
739	4	14	2	12	-	-
739	4	14	1	10	-	-
739	4	14	2	10	-	-
739	4	14	2	8	-	-
739	5	14	-	-	-	-
739	5	14	1	10	-	-
739	6	14	-	-	-	-
739	1	12	2	10	-	-
739	1	12	4	10	-	-
739	1	12	2	8	-	-
739	1	12	1	6	-	-
739	2	12	1	10	-	-
739	2	12	2	10	-	-
739	2	12	2	8	-	-
739	2	12	1	6	-	-
739	3	12	-	-	-	-
739	3	12	1	10	-	-
739	3	12	2	10	-	-
739	4	12	-	-	-	-
739	4	12	1	10	-	-
739	5	12	-	-	-	-
739	6	12	-	-	-	-
739	1	10	1	8	-	-
739	1	10	2	8	-	-
739	1	10	1	6	-	-
739	2	10	-	-	-	-
739	2	10	1	8	-	-
739	2	10	1	6	-	-
739	3	10	-	-	-	-

Model number	Number of cond.	AWG	+ Number of cond.	AWG	+ Number of cond.	AWG
739	3	10	1	8	-	-
739	4	10	-	-	-	-
739	5	10	-	-	-	-
739	1	8	1	6	-	-
739	2	8	-	-	-	-
739	3	8	-	-	-	-
739	2	6	-	-	-	-
822	1	22	2	20	-	-
822	1	22	3	20	-	-
822	1	22	4	20	-	-
822	1	22	2	18	-	-
822	1	22	3	18	-	-
822	1	22	4	18	-	-
822	2	22	1	20	-	-
822	2	22	2	20	-	-
822	2	22	3	20	-	-
822	2	22	1	18	-	-
822	2	22	2	18	-	-
822	2	22	3	18	-	-
822	2	22	1	16	-	-
822	2	22	3	16	-	-
822	3	22	1	20	-	-
822	3	22	2	20	-	-
822	3	22	1	18	-	-
822	3	22	2	18	-	-
822	3	22	1	16	-	-
822	4	22	-	-	-	-
822	4	22	1	20	-	-
822	4	22	1	18	-	-
822	4	22	1	16	-	-
822	5	22	-	-	-	-
822	1	20	2	18	-	-
822	1	20	3	18	-	-
822	1	20	4	18	-	-
822	2	20	1	18	-	-
822	2	20	2	18	-	-
822	2	20	3	18	-	-
822	2	20	1	16	-	-
822	2	20	3	16	-	-
822	3	20	-	-	-	-
822	3	20	1	18	-	-
822	3	20	2	18	-	-
822	3	20	1	16	-	-
822	4	20	-	-	-	-
822	4	20	1	18	-	-
822	4	20	1	16	-	-
822	5	20	-	-	-	-

Wire combination reference guide

Model number	Number of cond.	AWG	+ Number of cond.	AWG	+ Number of cond.	AWG
822	1	18	2	16	-	-
822	1	18	3	16	-	-
822	1	18	4	16	-	-
822	1	18	5	16	-	-
822	1	18	2	14	-	-
822	1	18	1	12	-	-
822	1	18	2	12	-	-
822	1	18	3	12	-	-
822	2	18	-	-	-	-
822	2	18	1	16	-	-
822	2	18	2	16	-	-
822	2	18	3	16	-	-
822	2	18	4	16	-	-
822	2	18	1	14	-	-
822	2	18	2	14	-	-
822	2	18	1	12	-	-
822	2	18	2	12	-	-
822	2	18	3	12	-	-
822	3	18	-	-	-	-
822	3	18	1	16	-	-
822	3	18	2	16	-	-
822	3	18	3	16	-	-
822	3	18	1	14	-	-
822	3	18	1	12	-	-
822	4	18	-	-	-	-
822	4	18	1	16	-	-
822	4	18	2	16	-	-
822	4	18	1	12	-	-
822	5	18	-	-	-	-
822	5	18	1	12	-	-
822	6	18	-	-	-	-
822	1	16	2	14	-	-
822	1	16	3	14	-	-
822	1	16	4	14	-	-
822	1	16	2	12	-	-
822	1	16	3	12	-	-
822	1	16	4	12	-	-
822	1	16	2	10	-	-
822	2	16	-	-	-	-
822	2	16	1	14	-	-
822	2	16	2	14	-	-
822	2	16	3	14	-	-
822	2	16	1	12	-	-
822	2	16	2	12	-	-
822	2	16	3	12	-	-
822	2	16	1	10	-	-
822	2	16	2	10	-	-
822	2	16	1	8	-	-

Model number	Number of cond.	AWG	+ Number of cond.	AWG	+ Number of cond.	AWG
822	3	16	-	-	-	-
822	3	16	1	14	-	-
822	3	16	1	12	-	-
822	3	16	2	12	-	-
822	3	16	1	8	-	-
822	4	16	-	-	-	-
822	4	16	1	14	-	-
822	4	16	1	12	-	-
822	4	16	1	8	-	-
822	5	16	-	-	-	-
822	1	14	2	12	-	-
822	1	14	3	12	-	-
822	1	14	4	12	-	-
822	1	14	2	10	-	-
822	2	14	-	-	-	-
822	2	14	1	12	-	-
822	2	14	2	12	-	-
822	2	14	3	12	-	-
822	2	14	1	10	-	-
822	2	14	2	10	-	-
822	2	14	1	8	-	-
822	3	14	-	-	-	-
822	3	14	1	12	-	-
822	3	14	2	12	-	-
822	3	14	1	10	-	-
822	3	14	1	8	-	-
822	4	14	-	-	-	-
822	4	14	1	12	-	-
822	4	14	1	10	-	-
822	5	14	1	10	-	-
822	1	12	2	10	-	-
822	2	12	-	-	-	-
822	2	12	1	10	-	-
822	2	12	1	8	-	-
822	3	12	-	-	-	-
822	3	12	1	10	-	-
822	4	12	-	-	-	-
822	5	12	-	-	-	-
822	2	10	-	-	-	-
822	3	10	-	-	-	-
822	2	8	-	-	-	-
833	1	22	2	20	-	-
833	1	22	3	20	-	-
833	1	22	4	20	-	-
833	1	22	2	18	-	-
833	1	22	3	18	-	-
833	1	22	4	18	-	-

Wire combination reference guide

Model number	Number of cond.	AWG	+ Number of cond.	AWG	+ Number of cond.	AWG
833	2	22	1	20	-	-
833	2	22	2	20	-	-
833	2	22	3	20	-	-
833	2	22	1	18	-	-
833	2	22	2	18	-	-
833	2	22	3	18	-	-
833	2	22	1	16	-	-
833	2	22	2	16	-	-
833	2	22	3	16	-	-
833	3	22	1	20	-	-
833	3	22	2	20	-	-
833	3	22	1	18	-	-
833	3	22	2	18	-	-
833	3	22	1	16	-	-
833	4	22	-	-	-	-
833	4	22	1	20	-	-
833	4	22	1	18	-	-
833	4	22	1	16	-	-
833	5	22	-	-	-	-
833	1	20	2	18	-	-
833	1	20	3	18	-	-
833	1	20	4	18	-	-
833	2	20	1	18	-	-
833	2	20	2	18	-	-
833	2	20	3	18	-	-
833	2	20	1	16	-	-
833	2	20	2	16	-	-
833	2	20	3	16	-	-
833	3	20	-	-	-	-
833	3	20	1	18	-	-
833	3	20	2	18	-	-
833	3	20	1	16	-	-
833	4	20	-	-	-	-
833	4	20	1	18	-	-
833	4	20	1	16	-	-
833	5	20	-	-	-	-
833	1	18	1	16	-	-
833	1	18	2	16	-	-
833	1	18	3	16	-	-
833	1	18	4	16	-	-
833	1	18	5	16	-	-
833	1	18	2	14	-	-
833	1	18	1	12	-	-
833	1	18	2	12	-	-
833	1	18	3	12	-	-
833	2	18	-	-	-	-
833	2	18	1	16	-	-
833	2	18	2	16	-	-
833	2	18	1	12	-	-
833	2	18	2	12	-	-

Model number	Number of cond.	AWG	+ Number of cond.	AWG	+ Number of cond.	AWG
833	2	18	3	16	-	-
833	2	18	4	16	-	-
833	2	18	1	14	-	-
833	2	18	2	14	-	-
833	2	18	1	12	-	-
833	2	18	2	12	-	-
833	2	18	3	12	-	-
833	3	18	-	-	-	-
833	3	18	1	16	-	-
833	3	18	2	16	-	-
833	3	18	3	16	-	-
833	3	18	1	14	-	-
833	3	18	1	12	-	-
833	4	18	-	-	-	-
833	4	18	1	16	-	-
833	4	18	2	16	-	-
833	4	18	1	12	-	-
833	5	18	-	-	-	-
833	5	18	1	12	-	-
833	6	18	-	-	-	-
833	1	16	2	14	-	-
833	1	16	3	14	-	-
833	1	16	4	14	-	-
833	1	16	2	12	-	-
833	1	16	3	12	-	-
833	1	16	4	12	-	-
833	1	16	2	10	-	-
833	2	16	-	-	-	-
833	2	16	1	14	-	-
833	2	16	2	14	-	-
833	2	16	3	14	-	-
833	2	16	1	12	-	-
833	2	16	2	12	-	-
833	2	16	3	12	-	-
833	2	16	1	10	-	-
833	2	16	2	10	-	-
833	2	16	1	8	-	-
833	3	16	-	-	-	-
833	3	16	1	14	-	-
833	3	16	2	14	-	-
833	3	16	1	12	-	-
833	3	16	2	12	-	-
833	3	16	1	8	-	-
833	4	16	-	-	-	-
833	4	16	1	14	-	-
833	4	16	1	12	-	-
833	4	16	1	8	-	-
833	5	16	-	-	-	-

Wire combination reference guide

Model number	Number of cond.	AWG	+ Number of cond.	AWG	+ Number of cond.	AWG
833	1	14	2	12	-	-
833	1	14	3	12	-	-
833	1	14	4	12	-	-
833	1	14	2	10	-	-
833	2	14	-	-	-	-
833	2	14	1	12	-	-
833	2	14	2	12	-	-
833	2	14	3	12	-	-
833	2	14	1	10	-	-
833	2	14	2	10	-	-
833	2	14	1	8	-	-
833	3	14	-	-	-	-
833	3	14	1	12	-	-
833	3	14	2	12	-	-
833	3	14	1	10	-	-
833	3	14	1	8	-	-
833	4	14	-	-	-	-
833	4	14	1	12	-	-
833	4	14	1	10	-	-
833	5	14	-	-	-	-
833	1	12	2	10	-	-
833	2	12	-	-	-	-
833	2	12	1	10	-	-
833	2	12	1	8	-	-
833	3	12	-	-	-	-
833	3	12	1	10	-	-
833	4	12	-	-	-	-
833	2	10	-	-	-	-
833	3	10	-	-	-	-
933	1	22	1	20	-	-
933	1	22	2	20	-	-
933	1	22	3	20	-	-
933	1	22	4	20	-	-
933	1	22	5	20	-	-
933	1	22	1	18	-	-
933	1	22	2	18	-	-
933	1	22	3	18	-	-
933	1	22	4	18	-	-
933	1	22	5	18	-	-
933	1	22	1	16	-	-
933	1	22	2	16	-	-
933	1	22	3	16	-	-
933	1	22	4	16	-	-
933	1	22	5	16	-	-
933	2	22	1	20	-	-
933	2	22	2	20	-	-
933	2	22	3	20	-	-
933	2	22	4	20	-	-

Model number	Number of cond.	AWG	+ Number of cond.	AWG	+ Number of cond.	AWG
933	2	22	1	18	-	-
933	2	22	2	18	-	-
933	2	22	3	18	-	-
933	2	22	4	18	-	-
933	2	22	1	16	-	-
933	2	22	2	16	-	-
933	2	22	3	16	-	-
933	2	22	4	16	-	-
933	3	22	1	20	-	-
933	3	22	2	20	-	-
933	3	22	3	20	-	-
933	3	22	1	18	-	-
933	3	22	2	18	-	-
933	3	22	3	18	-	-
933	3	22	4	18	-	-
933	3	22	1	16	-	-
933	3	22	2	16	-	-
933	3	22	3	16	-	-
933	3	22	-	-	-	-
933	4	22	1	20	-	-
933	4	22	2	20	-	-
933	4	22	1	18	-	-
933	4	22	2	18	-	-
933	4	22	1	16	-	-
933	4	22	2	16	-	-
933	4	22	-	-	-	-
933	5	22 Sol.	-	-	-	-
933	6	22 Sol.	-	-	-	-
933	1	20	1	18	-	-
933	1	20	2	18	-	-
933	1	20	3	18	-	-
933	1	20	4	18	-	-
933	1	20	1	16	-	-
933	1	20	2	16	-	-
933	1	20	3	16	-	-
933	1	20	4	16	-	-
933	1	20	1	14	-	-
933	1	20	2	14	-	-
933	1	20	3	14	-	-
933	1	20	4	14	-	-
933	2	20	1	18	-	-
933	2	20	2	18	-	-
933	2	20	3	18	-	-
933	2	20	1	16	-	-
933	2	20	2	16	-	-
933	2	20	3	16	-	-
933	2	20	1	14	-	-
933	2	20	2	14	-	-

Wire combination reference guide

Model number	Number of cond.	AWG	+ Number of cond.	AWG	+ Number of cond.	AWG
933	2	20	2	14	-	-
933	2	20	3	14	-	-
933	2	20	-	-	-	-
933	3	20	1	18	-	-
933	3	20	2	18	-	-
933	3	20	1	16	-	-
933	3	20	2	16	-	-
933	3	20	1	14	-	-
933	3	20	2	14	-	-
933	3	20	-	-	-	-
933	4	20	1	18	-	-
933	4	20	2	18	-	-
933	4	20	1	16	-	-
933	4	20	2	16	-	-
933	4	20	1	14	-	-
933	4	20	2	14	-	-
933	4	20	-	-	-	-
933	5	20 Sol.	-	-	-	-
933	6	20 Sol.	-	-	-	-
933	1	18	1	16	-	-
933	1	18	2	16	-	-
933	1	18	3	16	-	-
933	1	18	4	16	-	-
933	1	18	5	16	-	-
933	1	18	1	14	-	-
933	1	18	2	14	-	-
933	1	18	3	14	-	-
933	1	18	4	14	-	-
933	1	18	1	12	-	-
933	1	18	2	12	-	-
933	1	18	3	12	-	-
933	1	18	4	12	-	-
933	1	18	1	10	-	-
933	1	18	2	10	-	-
933	2	18	1	16	-	-
933	2	18	2	16	-	-
933	2	18	3	16	-	-
933	2	18	4	16	-	-
933	2	18	1	14	-	-
933	2	18	2	14	-	-
933	2	18	3	14	-	-
933	2	18	4	14	-	-
933	2	18	1	12	-	-
933	2	18	2	12	-	-
933	2	18	3	12	-	-
933	2	18	1	10	-	-
933	2	18	2	10	-	-

Model number	Number of cond.	AWG	+ Number of cond.	AWG	+ Number of cond.	AWG
933	2	18	-	-	-	-
933	3	18	1	16	-	-
933	3	18	2	16	-	-
933	3	18	3	16	-	-
933	3	18	1	14	-	-
933	3	18	2	14	-	-
933	3	18	3	14	-	-
933	3	18	1	12	-	-
933	3	18	2	12	-	-
933	3	18	3	12	-	-
933	3	18	1	10	-	-
933	3	18	2	10	-	-
933	3	18	-	-	-	-
933	4	18	1	16	-	-
933	4	18	2	16	-	-
933	4	18	1	14	-	-
933	4	18	2	14	-	-
933	4	18	1	12	-	-
933	4	18	2	12	-	-
933	4	18	1	10	-	-
933	4	18	-	-	-	-
933	5	18	1	16	-	-
933	5	18	1	14	-	-
933	5	18	1	12	-	-
933	5	18	-	-	-	-
933	6	18	-	-	-	-
933	1	16	1	14	-	-
933	1	16	1	14	-	-
933	1	16	1	14	-	-
933	1	16	2	14	-	-
933	1	16	2	14	-	-
933	1	16	2	14	-	-
933	1	16	3	14	-	-
933	1	16	4	14	-	-
933	1	16	1	12	-	-
933	1	16	1	12	-	-
933	1	16	2	12	-	-
933	1	16	3	12	-	-
933	1	16	4	12	-	-
933	1	16	1	10	-	-
933	1	16	2	10	-	-
933	2	16	1	14	-	-
933	2	16	1	14	-	-
933	2	16	1	14	-	-
933	2	16	2	14	-	-
933	2	16	2	14	-	-
933	2	16	3	14	-	-

Wire combination reference guide

Model number	Number of cond.	AWG	+ Number of cond.	AWG	+ Number of cond.	AWG
933	2	16	4	14	-	-
933	2	16	1	12	-	-
933	2	16	1	12	-	-
933	2	16	2	12	-	-
933	2	16	3	12	-	-
933	2	16	1	10	-	-
933	2	16	2	10	-	-
933	2	16	1	8 Strd.	-	-
933	2	16	-	-	-	-
933	3	16	1	14	-	-
933	3	16	1	14	-	-
933	3	16	1	14	-	-
933	3	16	2	14	-	-
933	3	16	3	14	-	-
933	3	16	1	12	-	-
933	3	16	2	12	-	-
933	3	16	1	10	-	-
933	3	16	2	10	-	-
933	3	16	1	8 Strd.	-	-
933	3	16	-	-	-	-
933	4	16	1	14	-	-
933	4	16	2	14	-	-
933	4	16	1	12	-	-
933	4	16	1	12	-	-
933	4	16	2	12	-	-
933	4	16	1	10	-	-
933	4	16	1	8 Strd.	-	-
933	4	16	-	-	-	-
933	5	16	1	14	-	-
933	5	16	1	10	-	-
933	5	16	-	-	-	-
933	6	16	-	-	-	-
933	1	14	1	12	-	-
933	1	14	1	12	-	-
933	1	14	2	12	-	-
933	1	14	2	12	-	-
933	1	14	3	12	-	-
933	1	14	4	12	-	-
933	1	14	1	10	-	-
933	1	14	2	10	-	-
933	1	14	1	8 Strd.	-	-
933	1	14	-	-	-	-
933	2	14	1	12	-	-
933	2	14	1	12	-	-
933	2	14	2	12	-	-
933	2	14	3	12	-	-
933	2	14	1	10	-	-

Model number	Number of cond.	AWG	+ Number of cond.	AWG	+ Number of cond.	AWG
933	2	14	1	8 Strd.	-	-
933	2	14	-	-	-	-
933	3	14	1	12	-	-
933	3	14	2	12	-	-
933	3	14	1	10	-	-
933	3	14	1	8 Strd.	-	-
933	3	14	-	-	-	-
933	4	14	1	12	-	-
933	4	14	1	10	-	-
933	4	14	-	-	-	-
933	5	14	-	-	-	-
933	1	12	1	10	-	-
933	1	12	2	10	-	-
933	1	12	1	8 Strd.	-	-
933	1	12	-	-	-	-
933	2	12	1	10	-	-
933	2	12	1	8 Strd.	-	-
933	2	12	-	-	-	-
933	3	12	1	10	-	-
933	3	12	-	-	-	-
933	4	12	-	-	-	-
933	1	10	1	8 Strd.	-	-
933	1	10	-	-	-	-
933	2	10	-	-	-	-
933	3	10	-	-	-	-

B

Sta-Kon® - Termination products



—

B

Sta-Kon - Termination products

Table of contents

Section B

Overview	B4
Ring terminals	B8
Flag terminals	B23
Fork terminals	B24
Pin terminals	B30
Butt splices	B31
Butt splices and parallel splices	B33
Wire joints	B34
Heat-shrinkable terminals, splices and disconnects	B37
Disconnects and male tabs	B39
Luminaire disconnects	B46
Ferrules	B48
Installing kits	B53
Application tools	B56
Die selection chart	B68
Wire guide table	B71
Military standard cross reference	B75
Packaging cross reference	B76
Catamount® terminals	B80
Catamount terminal tools	B83
Insulated terminals	B84
Insulated disconnects	B91
Insulated butt splices	B94
Insulated wire joints	B95
Tools	B96

Overview

Experience the Sta-Kon advantage.



Sta-Kon developed the first tool-applied solderless terminals and connectors more than 70 years ago in response to industry awareness of the need for better performance of electrical systems.

Key features and benefits

- Metal insulation grip sleeve is included on all nylon terminal for strain relief
- Long barrel selectively annealed
- CSA Certified
- UL Listed unless otherwise specified

Deep internal serrations

After the insertion of a wire into the terminal's barrel, a deep, serrated interior ensures a large area of contact that lowers the resistance of a connection. With the mechanical force of the tool, the wire strands cold flow into the serrated interior. This guarantees electrical resistance lower than the wire to which it is applied. This feature also prevents pullout from vibration and mechanical strain. Deep internal serrations can be compared to the effective holding power of a well-treaded tire on a wet highway.

Funneled terminal barrel entry

This feature makes wire insertion faster and easier. A funneled barrel eliminates wire strand "hang up" upon insertion into the terminal's barrel. The loss of even a couple of wire strands can have negative results on electrical efficiency and resistance to mechanical strain.

Sta-Kon long barrel design

If lowering electrical resistance, preventing wire pullout, eliminating a "missed" crimp and having an insulator that stays on the barrel during installation are your goals, then you must design a terminal with a long barrel. This also provides the insulator with additional surface area, holding tight to the barrel. Most competitive barrel lengths range from 20–50% shorter than Sta-Kon terminals. The results are usually a stream of electrical failure, rework and added expense. Many competitive insulators come off during crimping due to a limited barrel length.

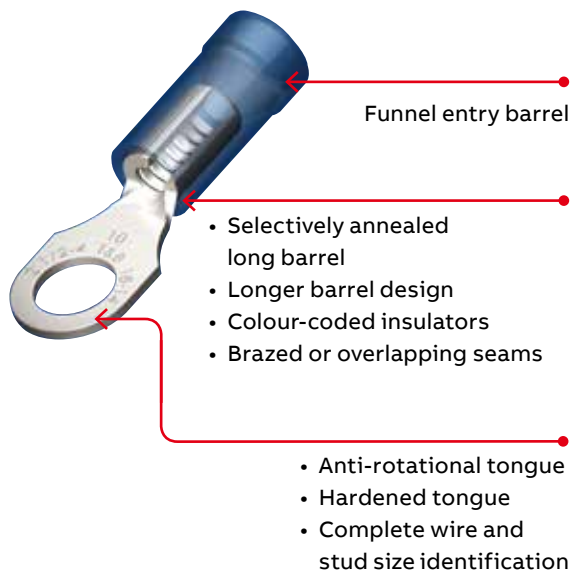

Note: Listed for solid wire up to #10 AWG, terminals only.

Why Sta-Kon terminals are better

Selective annealing

Because of the mechanical strength of copper, an installer can experience fatigue associated with repeated installations. For this reason, ABB puts our terminals through one more step called selective annealing. This process leaves the barrel soft enough to crimp and form around the wire. However, we “cold form” the tongue during the manufacturing process so it remains strong. This is done so the tongue can withstand repeated bends and bolt tightening strain common in most electrical installations. Many competitors attempt to accomplish similar goals by removing valuable material or using a softer copper that has lower conductivity. This increases electrical resistance as well as the odds for shorting and downtime.

Anti-rotational tongues

This is a unique feature to the ABB ring tongue terminal. This design prevents terminal shorting by keeping the terminal secure in the terminal block. The installer can place a greater number of terminals closer together without worry.

Proper identification

We identify all terminals with wire and stud sizes. These markings are clearly visible on the surface of the tongue, taking any guesswork out of replacing or reordering additional parts. Our superior bright plating also assists in visibility.

All Sta-Kon terminals are deburred and degreased

To ensure a Sta-Kon terminal is properly plated and insulated, all our parts are put through a process that cleans and smooths the terminal of any manufacturing residues, mainly grease, oils and sharp edges. Many competitive products do not put their product through such rigorous finishing.

Platings

Electro-plated tin is the standard. All others require minimum order quantities and are generally not stocked. Alternative platings as follows: gold, silver, tin-alloys, nickel, etc. The following finishes are available on most one-piece Sta-Kon terminals:

Finish	Suffix	Spec.	Temp. Rating
Gold plate	GP	MIL-G-45204 Type II, Grade B, C, D, Class O	260 °C
Nickel plate	NP	QQ-N-290 Class 2, Grade G	260 °C
Plain finish	PF	None	150 °C
Silver plate	SP	MIL-T-16366 Type I, or II, 400°F, 204°C	150 °C
Tin plate	TP	MIL-T-10727 Type I	150 °C

To order, add the indicated suffix to the regular catalogue number.

Underwriters Laboratories listing

Sta-Kon rings, forks, locking forks, two-way splices and disconnects are tested and listed to UL standards and all applicable products to CSA standards.

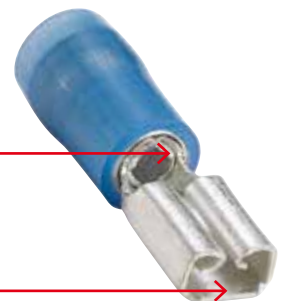

Deep internal serrations

- Flat bottom box
- Electro-tin plating
- Center reinforced spring detent for minimum insertion force
- Compound spring rails provide positive contact after repeated insertions

Overview

—
01 ERG4001

Sta-Kon ring, fork and locking fork

- Complete line of installing tools engineered to match tool with terminal
- First to gain military approval for pressure connections ... many styles available for military applications
- Sta-Kon products exceed test specification requirements of military, UL and CSA
- Fluoropolymer and nylon terminals provided with extra metal sleeve to grip insulation
- Vinyl-insulated and bare Sta-Kon terminals feature brazed seam wire barrels that can be crimped at any place on the barrel circumference
- Ring and fork terminals can be used with solid wire as follows:
 - Non-insulated: 22–8 AWG
 - Insulated: 22–10 AWG

Sta-Kon disconnects

- Internal barrel serrations and long barrel provide for maximum tensile strength
- Complete line of installing tools, engineered to match tool with terminal
- Funnel entry insulators allow for easier inserting of wire into barrel
- Colour-coded for easy installation

The Shure-Stake® tools are matched to terminals

The Shure-Stake mechanism prevents the dies from releasing the terminal until the proper compression has been completed. With this method, an operator achieves a reliable crimp everytime. ABB tooling techniques correctly match tools, wire size and terminal to produce optimum mechanical and electrical performance.





Sta-Kon RA, RB and RC insulated quick disconnect products are now UL Listed at 600 volts.

Sta-Kon technical data

Terminals and splices insulation rating	UL 94 flammability	Voltage	Temperature
Nylon	V-2	600	105 °C
Vinyl	V-0	600	105 °C
Tefzel®	V-0	600	105 °C
Disconnects (non-insulated)		300	105 °C

Tefzel is a registered trademark of DuPont.

The Sta-Kon terminals numbering system

Distributor package 100/50
Bulk OEM package 1000/500

Common to both packages

- Letter **A** denotes 22–18 AWG wire range = Red
- Letter **B** denotes 16–14 AWG wire range = Blue
- Letter **C** denotes 26–22 AWG, 12–10 AWG wire range = Yellow
- Letter **R** preceding the above letters indicates the terminal is insulated
- No letter **R**... no insulation... no exception!

Distributor packaged

Part numbers are very descriptive, indicating insulation and type, stud size, tongue style and the largest maximum wire that can be put inside.

- If the letter **R precedes** the number, the part is nylon insulated – RA18-6
- If the letter **R follows** the number, the part is vinyl insulated – 14RB-8

Example: 10RC-8F

C	Indicates 12–10 AWG
10RC	Vinyl insulated
8	Indicates stud size
F	Means a fork tongue terminal
FL	Would indicate locking fork

Example: 2RA18X

2	Indicates a 2-way or butt-style connector
X	Means expanded insulation

Ring terminals

Nylon-insulated ring terminals



- Complete line of installing tools engineered to match tool with terminal
- First to gain military approval for pressure connections... many styles available for military applications
- Sta-Kon products exceed test specification requirements of military, UL and CSA
- Include extra metal sleeve to grip insulation
- Vinyl insulated and bare Sta-Kon terminals feature brazed seam wire barrels that can be crimped at any place on the barrel circumference
- Can be installed with crimping tools having a single indentor or double indentor (recommended for solid wire)
- Serrated barrel increases grip on wire
- Wire range identification on the tongue of each terminal
- Constructed of electrolytic copper for high conductivity



Cat. no.	Wire Pkg. range qty. (AWG)	Max. ins. (in.)	Bolt hole (in.)	Rec. tool	Dimensions (in.)				Stock thick. (in.)
					A	B	C	M	
RZ22-2**	100 26-22	0.083	#2	ERG4006	0.57	0.14	0.13	0.49	0.02
RZ22-4**	100 26-22	0.083	#4	ERG4006	0.65	0.21	0.20	0.54	0.02
RZ22-6**	100 26-22	0.083	#6	ERG4006	0.65	0.21	0.20	0.54	0.02
RZ22-8**	100 26-22	0.083	#8	ERG4006	0.75	0.25	0.23	0.62	0.02
RZ22-10**	100 26-22	0.083	#10	ERG4006	0.75	0.25	0.23	0.62	0.02
RAX23*	1,000 26-24	0.125	#2	WT145A	0.66	0.14	0.14	0.59	0.02
RAX43*	1,000 26-24	0.125	#4	WT145A	0.74	0.20	0.19	0.64	0.02
RAX63*	1,000 26-24	0.125	#6	WT145A	0.84	0.25	0.22	0.72	0.02
RAX83*	1,000 26-24	0.125	#8	WT145A	0.84	0.25	0.22	0.72	0.02
RAX103*	1,000 26-24	0.125	#10	WT145A	0.84	0.25	0.24	0.72	0.02
RA18-4	100 22-16	0.136	#4	ERG4001	0.72	0.23	0.14	0.59	0.03
RA323	1,000 22-16	0.136	#4	ERG4001	0.72	0.23	0.14	0.59	0.03
RA333	1,000 22-16	0.136	#6	ERG4001	0.72	0.23	0.14	0.59	0.03
RA18-6	100 22-16	0.136	#6	ERG4001	0.86	0.26	0.25	0.71	0.03

* Not listed by UL or CSA

** CSA Certified only

Most standard bulk catalogue numbers can be put on mylar tape for reel feed applications (i.e. 12050 tool and application). Please add suffix M for mylar tape i.e. RA2573M.



Cat. no.	Wire Pkg. range qty. (AWG)	Max. ins. (in.)	Bolt hole (in.)	Rec. tool	Dimensions (in.)				Stock thick. (in.)
					A	B	C	M	
RA853	1,000 22-16	0.136	#6	WT145A	0.86	0.26	0.25	0.71	0.03
RA18-8	100 22-16	0.136	#8	WT145A	0.89	0.26	0.25	0.71	0.03
RA833	1,000 22-16	0.136	#8	WT145A	0.86	0.26	0.25	0.71	0.03
RA863	1,000 22-16	0.136	#8	WT145A	0.89	0.26	0.25	0.71	0.03
RA18-10	100 22-16	0.136	#10	WT145A	0.89	0.31	0.25	0.71	0.03
RA873	1,000 22-16	0.136	#10	WT145A	0.89	0.31	0.25	0.71	0.03
RA18-14	100 22-16	0.136	¼	WT145A	1.10	0.46	0.31	0.84	0.03
RA713	1,000 22-16	0.136	¼	WT145A	1.10	0.46	0.31	0.84	0.03
RA18-516	100 22-16	0.136	⅜	WT145A	1.10	0.46	0.31	0.84	0.03
RA723	1,000 22-16	0.136	⅜	ERG4001	1.10	0.46	0.31	0.84	0.03
RA18-38	100 22-16	0.136	⅝	ERG4001	1.20	0.53	0.35	0.87	0.03
RA733	1,000 22-16	0.136	⅝	ERG4001	1.20	0.53	0.35	0.87	0.03
RA18-12	100 22-16	0.136	½	ERG4001	1.30	0.72	0.50	0.92	0.03
RA753	1,000 22-16	0.136	½	ERG4001	1.30	0.72	0.50	0.92	0.03

Diagram

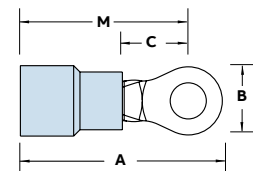

Ring terminals

Nylon-insulated ring terminals



Cat. no.	Pkg. qty.	Wire range (AWG)	Max. ins. (in.)	Bolt hole (in.)	Rec. tool	Dimensions (in.)				Stock thick. (in.)
						A	B	C	M	
RB14-4	100	18-14	0.162	#4	ERG4001	0.72	0.26	0.14	0.59	0.03
RB1323	1,000	18-14	0.162	#4	ERG4001	0.72	0.26	0.14	0.59	0.03
RB14-6	100	18-14	0.162	#6	ERG4001	0.89	0.31	0.25	0.71	0.03
RB853	1,000	18-14	0.162	#6	ERG4001	0.89	0.31	0.25	0.71	0.03
RB1333	1,000	18-14	0.162	#6	ERG4001	0.74	0.26	0.14	0.59	0.03
RB14-8	100	18-14	0.162	#8	ERG4001	0.89	0.31	0.25	0.71	0.03
RB863	1,000	18-14	0.162	#8	ERG4001	0.89	0.31	0.25	0.71	0.03
RB14-10	100	18-14	0.162	#10	ERG4001	0.89	0.31	0.25	0.71	0.03
RB873	1,000	18-14	0.162	#10	ERG4001	0.89	0.31	0.25	0.71	0.03
RB14-14	100	18-14	0.162	1/4	ERG4001	1.08	0.47	0.31	0.81	0.03
RB713	1,000	18-14	0.162	1/4	ERG4001	1.08	0.47	0.31	0.81	0.03
RB14-516	100	18-14	0.162	5/16	ERG4001	1.08	0.47	0.31	0.84	0.03
RB723	1,000	18-14	0.162	5/16	ERG4001	1.08	0.47	0.31	0.84	0.03
RB14-38	100	18-14	0.162	3/8	ERG4001	1.17	0.53	0.35	0.87	0.03
RB733	1,000	18-14	0.162	3/8	ERG4001	1.17	0.53	0.35	0.87	0.03
RB14-12	100	18-14	0.162	1/2	ERG4001	1.25	0.72	0.50	0.90	0.03
RB753	1,000	18-14	0.162	1/2	ERG4001	1.25	0.72	0.50	0.90	0.03



Cat. no.	Pkg. qty.	Wire range (AWG)	Max. ins. (in.)	Bolt hole (in.)	Rec. tool	Dimensions (in.)				Stock thick. (in.)
						A	B	C	M	
RC10-6	50	12-10	0.210	#6	ERG4001	1.00	0.37	0.27	0.81	0.04
RC333	500	12-10	0.210	#6	ERG4001	1.00	0.37	0.27	0.81	0.04
RC10-8	50	12-10	0.210	#8	ERG4001	1.00	0.37	0.27	0.81	0.04
RC863	500	12-10	0.210	#8	ERG4001	1.00	0.37	0.27	0.81	0.04
RC10-10	50	12-10	0.210	#10	ERG4001	1.00	0.37	0.27	0.81	0.04
RC363	500	12-10	0.210	#10	ERG4001	1.00	0.37	0.27	0.81	0.04
RC10-14	50	12-10	0.210	1/4	ERG4001	1.12	0.53	0.32	0.86	0.04
RC713	500	12-10	0.210	1/4	ERG4001	1.12	0.53	0.32	0.86	0.04
RC10-516	50	12-10	0.210	5/16	ERG4001	1.21	0.53	0.31	0.94	0.04
RC703	500	12-10	0.210	5/16	ERG4001	1.21	0.53	0.31	0.94	0.04
RC10-38	50	12-10	0.210	3/8	ERG4001	1.27	0.59	0.35	0.98	0.04
RC733	500	12-10	0.210	3/8	ERG4001	1.27	0.59	0.35	0.98	0.04
RC10-12	50	12-10	0.210	1/2	ERG4001	1.37	0.72	0.52	1.02	0.04
RC753	500	12-10	0.210	1/2	ERG4001	1.37	0.72	0.52	1.02	0.04

Diagram

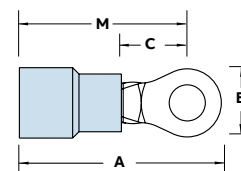

Ring terminals

Nylon-insulated ring terminals — expanded entry



Cat. no.	Pkg. qty.	Wire range AWG	Max. ins. (in.)	Bolt hole (in.)	Rec. tool	Dimensions (in.)				Stock thick. (in.)
						A	B	C	M	
RB14-4X	100	18-14	0.190	#4	ERG4001	0.80	0.26	0.14	0.67	0.03
RB14-6X	100	18-14	0.190	#6	ERG4001	0.95	0.31	0.25	0.79	0.03
RB854	1,000	18-14	0.190	#6	ERG4001	0.95	0.31	0.25	0.79	0.03
RB14-8X	100	18-14	0.190	#8	ERG4001	0.95	0.31	0.25	0.79	0.03
RB864	1,000	18-14	0.190	#8	ERG4001	0.95	0.31	0.25	0.79	0.03
RB14-10X	100	18-14	0.190	#10	ERG4001	0.95	0.31	0.25	0.79	0.03
RB874	1,000	18-14	0.190	#10	ERG4001	0.95	0.31	0.25	0.79	0.03
RB14-14X	100	18-14	0.190	¼	ERG4001	1.16	0.47	0.31	0.92	0.03
RB714	1,000	18-14	0.190	¼	ERG4001	1.16	0.47	0.31	0.92	0.03
RB14-516X	100	18-14	0.190	⅝	ERG4001	1.16	0.47	0.31	0.92	0.03
RB724	1,000	18-14	0.190	⅝	ERG4001	1.16	0.47	0.31	0.92	0.03
RB14-38X	100	18-14	0.190	¾	ERG4001	1.25	0.53	0.42	0.95	0.03
RB734	1,000	18-14	0.190	¾	ERG4001	1.25	0.53	0.42	0.95	0.03



Cat. no.	Pkg. qty.	Wire range AWG	Max. ins. (in.)	Bolt hole (in.)	Rec. tool	Dimensions (in.)				Stock thick. (in.)
						A	B	C	M	
RC10-6X	50	12-10	0.250	#6	ERG4001	1.10	0.37	0.27	0.91	0.04
RC334	500	12-10	0.250	#6	ERG4001	1.10	0.37	0.27	0.91	0.04
RC10-8X	50	12-10	0.250	#8	ERG4001	1.10	0.37	0.27	0.91	0.04
RC864	500	12-10	0.250	#8	ERG4001	1.10	0.37	0.27	0.91	0.04
RC10-10X	50	12-10	0.250	#10	ERG4001	1.10	0.37	0.27	0.91	0.04
RC364	500	12-10	0.250	#10	ERG4001	1.10	0.37	0.27	0.91	0.04
RC10-14X	50	12-10	0.250	¼	ERG4001	1.22	0.53	0.32	0.96	0.04
RC714	500	12-10	0.250	¼	ERG4001	1.22	0.53	0.32	0.96	0.04
RC10-516X	50	12-10	0.250	⅝	ERG4001	1.32	0.53	0.31	1.05	0.04
RC704	500	12-10	0.250	⅝	ERG4001	1.32	0.53	0.31	1.05	0.04
RC10-38X	50	12-10	0.250	¾	ERG4001	1.38	0.59	0.48	1.09	0.04
RC734	500	12-10	0.250	¾	ERG4001	1.38	0.59	0.48	1.09	0.04
RC10-12X	50	12-10	0.250	½	ERG4001	1.48	0.72	0.52	1.13	0.04

Diagram

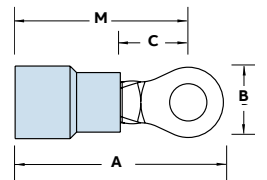

Ring terminals

Nylon-insulated large ring terminals



Cat. no.	Pkg. qty.	Wire range (AWG)	Max. ins. (in.)	Bolt hole (in.)	Rec. tool	Dimensions (in.)				Stock thick. (in.)
						A	B	C	M	
Flex class 41/24										
RD167	200	8	0.340	#8	ERG4007	1.48	0.42	0.28	1.29	0.04
RD8-10	25	8	0.340	#10	ERG4007	1.48	0.42	0.28	1.29	0.04
RD367	200	8	0.340	#10	ERG4007	1.48	0.42	0.28	1.29	0.04
RD8-14	25	8	0.340	¼	ERG4007	1.54	0.46	0.36	1.32	0.04
RD717	200	8	0.340	¼	ERG4007	1.54	0.46	0.36	1.32	0.04
RD8-516	25	8	0.340	⅝	ERG4007	1.63	0.57	0.36	1.35	0.04
RD727	200	8	0.340	⅝	ERG4007	1.63	0.57	0.36	1.35	0.04
RD8-38	25	8	0.340	¾	ERG4007	1.63	0.57	0.36	1.35	0.04
RD737	200	8	0.340	¾	ERG4007	1.63	0.57	0.36	1.35	0.04
RD8-12*	25	8	0.310	½	TBM6S	1.79	0.82	0.55	1.39	0.04
RD757*	200	8	0.310	½	TBM6S	1.79	0.82	0.55	1.39	0.04
RD10161	200	8AN	0.270	#8	ERG4007	1.40	0.41	0.24	1.20	0.04
RD10361	200	8AN	0.270	#10	ERG4007	1.40	0.41	0.24	1.20	0.04
RD10711	200	8AN	0.270	¼	ERG4007	1.45	0.45	0.27	1.22	0.04
RD10721	200	8AN	0.270	⅝	ERG4007	1.53	0.56	0.34	1.25	0.04
RD10731	200	8AN	0.270	¾	ERG4007	1.53	0.56	0.34	1.25	0.04
Flex class 63/24										
RE6-10	20	6	0.420	#10	ERG4007	1.65	0.49	0.28	1.40	0.04
RE267	200	6	0.420	#10	ERG4007	1.65	0.49	0.28	1.40	0.04
RE6-14	20	6	0.420	¼	ERG4007	1.65	0.49	0.28	1.40	0.04
RE717	200	6	0.420	¼	ERG4007	1.65	0.49	0.28	1.40	0.04
RE6-516	20	6	0.420	⅝	ERG4007	1.76	0.61	0.34	1.47	0.04
RE727	200	6	0.420	⅝	ERG4007	1.76	0.61	0.34	1.47	0.04
RE6-38	20	6	0.420	¾	ERG4007	1.76	0.61	0.34	1.47	0.04
RE737	200	6	0.420	¾	ERG4007	1.76	0.61	0.34	1.47	0.04
RE6-12*	20	6	0.395	½	TBM6S	1.83	0.82	0.55	1.43	0.04
RE757*	200	6	0.395	½	TBM6S	1.83	0.82	0.55	1.43	0.04
RE10261	200	6AN	0.315	#10	ERG4007	1.55	0.49	0.24	1.31	0.04
RE10711	200	6AN	0.315	¼	ERG4007	1.55	0.49	0.27	1.31	0.04
RE10721	200	6AN	0.315	⅝	ERG4007	1.70	0.60	0.34	1.40	0.04
RE10731	200	6AN	0.315	¾	ERG4007	1.70	0.60	0.34	1.40	0.04



Cat. no.	Pkg. qty.	Wire range AWG	Max. ins. (in.)	Bolt hole (in.)	Rec. tool	Dimensions (in.)				Stock thick. (in.)
						A	B	C	M	
Flex Class 105/24										
RF4-10	15	4	0.510	#10	TBM6S	1.76	0.56	0.36	1.49	0.04
RF267	100	4	0.510	#10	TBM6S	1.76	0.56	0.36	1.49	0.04
RF4-14	15	4	0.510	¼	TBM6S	1.76	0.56	0.36	1.49	0.04
RF717	100	4	0.510	¼	TBM6S	1.76	0.56	0.36	1.49	0.04
RF4-516	15	4	0.510	⅝	TBM6S	1.84	0.62	0.35	1.53	0.04
RF727	100	4	0.510	⅝	TBM6S	1.84	0.62	0.35	1.53	0.04
RF4-38	15	4	0.510	¾	TBM6S	1.84	0.62	0.35	1.53	0.04
RF737	100	4	0.510	¾	TBM6S	1.84	0.62	0.35	1.53	0.04
RF757*	100	4	0.500	½	TBM6S	1.90	0.82	0.55	1.49	0.04
RF10261	100	4AN	0.380	#10	TBM6S	1.78	0.55	0.30	1.51	0.04
RF10711	100	4AN	0.380	¼	TBM6S	1.78	0.55	0.30	1.51	0.04
RF10721	100	4AN	0.380	⅝	TBM6S	1.80	0.62	0.34	1.49	0.04
RF10731	100	4AN	0.380	¾	TBM6S	1.80	0.62	0.34	1.49	0.04

*Brazead seam
AN=Aircraft wire

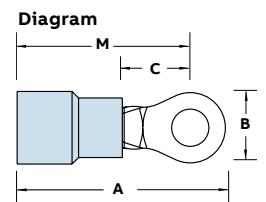

Ring terminals

Nylon-insulated large ring terminals (cont.)



Cat. no.	Pkg. qty.	Wire range (AWG)	Max. ins. (in.)	Bolt hole (in.)	Rec. tool	Dimensions (in.)				Stock thick. (in.)
						A	B	C	M	
RG2-10	10	2	0.588	#10	TBM6S	2.15	0.69	0.40	1.83	0.05
RG267	50	2	0.588	#10	TBM6S	2.15	0.69	0.40	1.83	0.05
RG2-14	10	2	0.588	¼	TBM6S	2.15	0.69	0.40	1.83	0.05
RG717	50	2	0.588	¼	TBM6S	2.15	0.69	0.40	1.83	0.05
RG2-516	10	2	0.588	⅝	TBM6S	2.15	0.69	0.40	1.83	0.05
RG727	50	2	0.588	⅝	TBM6S	2.15	0.69	0.40	1.83	0.05
RG2-38	10	2	0.588	¾	TBM6S	2.15	0.69	0.40	1.83	0.05
RG737	50	2	0.588	¾	TBM6S	2.15	0.69	0.40	1.83	0.05
RG2-12	10	2	0.588	½	TBM6S	2.35	0.80	0.49	1.93	0.05
RG757	50	2	0.588	½	TBM6S	2.35	0.80	0.49	1.93	0.05
RG9711	50	2AN	0.453	¼	TBM6S	2.07	0.69	0.40	1.74	0.05
RG9731	50	2AN	0.453	⅜	TBM6S	2.07	0.69	0.40	1.74	0.05
RG9751	50	2AN	0.453	½	TBM6S	2.26	0.80	0.49	1.84	0.05
RH717	50	1/0	0.629	¼	TBM6S	2.14	0.77	0.43	1.81	0.05
RH727	50	1/0	0.629	⅝	TBM6S	2.14	0.77	0.43	1.81	0.05
RH737	50	1/0	0.629	¾	TBM6S	2.14	0.77	0.43	1.81	0.05
RH757	50	1/0	0.629	½	TBM6S	2.34	0.77	0.54	1.90	0.05
RH9711	50	1AN	0.500	¼	TBM6S	2.14	0.77	0.44	1.81	0.05
RH9731	50	1AN	0.500	⅜	TBM6S	2.14	0.77	0.44	1.81	0.05
RH9751	50	1AN	0.500	½	TBM6S	2.34	0.77	0.54	1.90	0.05

Cat. no.	Pkg. qty.	Wire range AWG	Max. ins. (in.)	Bolt hole (in.)	Rec. tool	Dimensions (in.)				Stock thick. (in.)
						A	B	C	M	
RJ717	100	2/0	0.675	¼	TBM6S	2.34	0.83	0.46	1.96	0.06
RJ727	100	2/0	0.675	⅝	TBM6S	2.34	0.83	0.46	1.96	0.06
RJ737	100	2/0	0.675	¾	TBM6S	2.34	0.83	0.46	1.96	0.06
RJ757	100	2/0	0.675	½	TBM6S	2.48	0.89	0.54	2.03	0.06
RJ9711	50	1/0AN	0.550	¼	TBM6S	2.35	0.83	0.46	1.97	0.06
RJ9731	50	1/0AN	0.550	⅜	TBM6S	2.35	0.83	0.46	1.97	0.06
RJ9751	50	1/0AN	0.550	½	TBM6S	2.49	0.89	0.55	2.04	0.06
RK717	25	3/0	0.765	¼	TBM6S	2.60	0.93	0.54	2.21	0.06
RK727	25	3/0	0.765	⅝	TBM6S	2.60	0.93	0.54	2.21	0.06
RK737	25	3/0	0.765	¾	TBM6S	2.60	0.93	0.54	2.21	0.06
RK9731	100	2/0AN	0.610	⅜	TBM6S	2.52	0.93	0.55	2.14	0.06
RK9751	100	2/0AN	0.610	½	TBM6S	2.60	0.93	0.55	2.15	0.06
RL737	25	4/0	0.785	⅜	TBM6S	2.83	1.04	0.57	2.35	0.07
RL757	25	4/0	0.785	½	TBM6S	2.83	1.04	0.57	2.35	0.07
RL9731	25	3/0AN	0.680	⅜	TBM6S	2.83	1.04	0.57	2.36	0.07
RL9751	25	3/0AN	0.680	½	TBM6S	2.83	1.04	0.57	2.36	0.07
RM737	20	250	0.868	⅜	TBM6S	3.00	1.13	0.65	2.51	0.07
RM747	20	250	0.868	⅝	TBM6S	3.00	1.13	0.65	2.51	0.07
RM757	20	250	0.868	½	TBM6S	3.00	1.13	0.65	2.51	0.07
RM9731	20	4/0AN	0.750	⅜	TBM6S	3.00	1.13	0.66	2.51	0.07
RM9751	20	4/0AN	0.750	½	TBM6S	3.00	1.13	0.66	2.51	0.07

Diagram

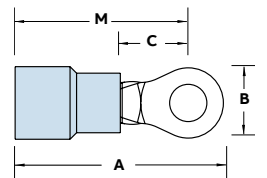

Ring terminals

Vinyl-insulated ring terminals



Extra-length PVC sleeve offers extra protection.



Cat. no.	Pkg. qty.	Wire range (AWG)	Max. ins. (in.)	Bolt hole (in.)	Rec. tool	Dimensions (in.)				Stock thick. (in.)
						A	B	C	M	
18RA-4	100	22-16	0.150	#4	ERG4001	0.97	0.31	0.27	0.81	0.03
RA77	1,000	22-16	0.150	#4	ERG4001	0.97	0.31	0.27	0.81	0.03
18RA-6	100	22-16	0.150	#6	ERG4001	0.94	0.25	0.27	0.81	0.03
RA857	1,000	22-16	0.150	#6	ERG4001	0.94	0.25	0.27	0.81	0.03
18RA-8	100	22-16	0.150	#8	ERG4001	0.97	0.31	0.27	0.81	0.03
RA867	1,000	22-16	0.150	#8	ERG4001	0.97	0.31	0.27	0.81	0.03
18RA-10	100	22-16	0.150	#10	ERG4001	0.97	0.31	0.27	0.81	0.03
RA877	1,000	22-16	0.150	#10	ERG4001	0.97	0.31	0.27	0.81	0.03
18RA-14	100	22-16	0.150	3/4	ERG4001	1.13	0.50	0.37	0.88	0.03
RA717	1,000	22-16	0.150	3/4	ERG4001	1.13	0.50	0.37	0.88	0.03
18RA-516	100	22-16	0.150	5/16	ERG4001	1.13	0.50	0.37	0.88	0.03
RA727	1,000	22-16	0.150	5/16	ERG4001	1.13	0.50	0.37	0.88	0.03
18RA-38	100	22-16	0.150	3/8	ERG4001	1.24	0.54	0.37	0.91	0.03
RA737	1,000	22-16	0.150	3/8	ERG4001	1.24	0.54	0.37	0.91	0.03
14RB-4	100	18-14	0.170	#4	ERG4001	0.94	0.25	0.27	0.81	0.03
RB1327	1,000	18-14	0.170	#4	ERG4001	0.94	0.25	0.27	0.81	0.03
14RB-6	100	18-14	0.170	#6	ERG4001	0.97	0.31	0.27	0.81	0.03
RB857	1,000	18-14	0.170	#6	ERG4001	0.97	0.31	0.27	0.81	0.03
14RB-8	100	18-14	0.170	#8	ERG4001	0.97	0.31	0.27	0.81	0.03
RB867	1,000	18-14	0.170	#8	ERG4001	0.97	0.31	0.27	0.81	0.03
14RB-10	100	18-14	0.170	#10	ERG4001	0.97	0.31	0.27	0.81	0.03
RB877	1,000	18-14	0.170	#10	ERG4001	0.97	0.31	0.27	0.81	0.03
14RB-14	100	18-14	0.170	3/4	ERG4001	1.14	0.50	0.38	0.89	0.03
RB717	1,000	18-14	0.170	3/4	ERG4001	1.14	0.50	0.38	0.89	0.03
14RB-516	100	18-14	0.170	5/16	ERG4001	1.15	0.50	0.38	0.89	0.03
RB727	1,000	18-14	0.170	5/16	ERG4001	1.15	0.50	0.38	0.89	0.03
14RB-38	100	18-14	0.170	3/8	ERG4001	1.16	0.54	0.38	0.91	0.03
RB737	1,000	18-14	0.170	3/8	ERG4001	1.16	0.54	0.38	0.91	0.03

Cat. no.	Pkg. qty.	Wire range (AWG)	Max. ins. (in.)	Bolt hole (in.)	Rec. tool	Dimensions (in.)				Stock thick. (in.)
						A	B	C	M	
10RC-6	50	12-10	0.210	#6	ERG4001	1.06	0.31	0.27	0.90	0.04
RC337	500	12-10	0.210	#6	ERG4001	1.06	0.31	0.27	0.90	0.04
10RC-8	50	12-10	0.210	#8	ERG4001	1.06	0.31	0.27	0.90	0.04
RC777	500	12-10	0.210	#8	ERG4001	1.06	0.31	0.27	0.90	0.04
10RC-10	50	12-10	0.210	#10	ERG4001	1.06	0.31	0.27	0.90	0.04
RC367	500	12-10	0.210	#10	ERG4001	1.06	0.31	0.27	0.90	0.04
10RC-14	50	12-10	0.210	3/4	ERG4001	1.16	0.50	0.27	0.90	0.04
RC717	500	12-10	0.210	3/4	ERG4001	1.16	0.50	0.27	0.90	0.04
10RC-516	50	12-10	0.210	5/16	ERG4001	1.17	0.50	0.37	0.92	0.04
RC707	500	12-10	0.210	5/16	ERG4001	1.17	0.50	0.37	0.92	0.04
10RC-38	50	12-10	0.210	3/8	ERG4001	1.29	0.59	0.44	0.99	0.04
RC737	500	12-10	0.210	3/8	ERG4001	1.29	0.59	0.44	0.99	0.04

Diagram

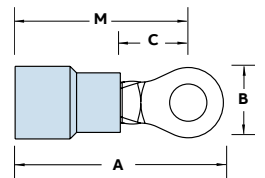

Ring terminals

Vinyl-insulated expanded insulation and large ring terminals



A wider wire entry for heavy-wall insulation



Vinyl-insulated ring terminals — Expanded insulation



Cat. no.	Pkg. qty.	Wire range (AWG)	Max. ins. (in.)	Bolt hole (in.)	Rec. tool	Dimensions (in.)				Stock thick. (in.)
						A	B	C	M	
18RA-4X	100	22-16	0.170	#4	ERG4001	0.97	0.31	0.27	0.81	0.03
18RA-6X	100	22-16	0.170	#6	ERG4001	0.97	0.31	0.27	0.81	0.03
18RA-8X	100	22-16	0.170	#8	ERG4001	0.97	0.31	0.27	0.81	0.03
18RA-38X	100	22-16	0.170	3/8	ERG4001	1.15	0.54	0.35	0.90	0.03
RA857-170	1,000	22-16	0.170	#6	ERG4001	0.97	0.31	0.27	0.81	0.03
RA867-170	1,000	22-16	0.170	#8	ERG4001	0.97	0.31	0.27	0.81	0.03
18RA-10X	1,000	22-16	0.170	#10	ERG4001	0.97	0.31	0.27	0.81	0.03
RA877-170	1,000	22-16	0.170	#10	ERG4001	0.97	0.31	0.27	0.81	0.03
18RA-14X	100	22-16	0.170	1/4	ERG4001	1.13	0.50	0.37	0.88	0.03
RA727-170	1,000	22-16	0.170	5/16	ERG4001	1.13	0.50	0.37	0.88	0.03
14RB-4X	100	18-14	0.200	#4	ERG4001	0.94	0.25	0.27	0.81	0.03
14RB-6X	100	18-14	0.200	#6	ERG4001	0.97	0.31	0.27	0.81	0.03
RB857-200	1,000	18-14	0.200	#6	ERG4001	0.97	0.31	0.27	0.81	0.03
14RB-8X	100	18-14	0.200	#8	ERG4001	0.97	0.31	0.27	0.81	0.03
RB867-200	1,000	18-14	0.200	#8	ERG4001	0.97	0.31	0.27	0.81	0.03
14RB-10X	100	18-14	0.200	#10	ERG4001	0.97	0.31	0.27	0.81	0.03
RB877-200	1,000	18-14	0.200	#10	ERG4001	0.97	0.31	0.27	0.81	0.03
14RB-14X	100	18-14	0.200	1/4	ERG4001	1.14	0.50	0.38	0.89	0.03
RB717-200	1,000	18-14	0.200	1/4	ERG4001	1.14	0.50	0.38	0.89	0.03
14RB-516X	100	18-14	0.200	5/16	ERG4001	1.15	0.50	0.38	0.89	0.03
14RB-38X	100	18-14	0.200	3/8	ERG4001	1.16	0.54	0.35	0.91	0.03
10RC-6X	50	12-10	0.250	#6	ERG4001	1.06	0.31	0.27	0.90	0.04
RC337-250	500	12-10	0.250	#6	ERG4001	1.06	0.31	0.27	0.90	0.04
10RC-8X	50	12-10	0.250	#8	ERG4001	1.06	0.31	0.27	0.90	0.04
RC777-250	500	12-10	0.250	#8	ERG4001	1.06	0.31	0.27	0.90	0.04
10RC-10X	50	12-10	0.250	#10	ERG4001	1.06	0.31	0.27	0.90	0.04
RC367-250	500	12-10	0.250	#10	ERG4001	1.06	0.31	0.27	0.90	0.04
10RC-14X	50	12-10	0.250	1/4	ERG4001	1.16	0.50	0.27	0.90	0.04
RC717-250	500	12-10	0.250	1/4	ERG4001	1.16	0.50	0.27	0.90	0.04
10RC-516X	50	12-10	0.250	5/16	ERG4001	1.17	0.50	0.37	0.92	0.04
10RC-38X	50	12-10	0.250	3/8	ERG4001	1.29	0.59	0.44	0.99	0.04
RC737-250	500	12-10	0.250	3/8	ERG4001	1.29	0.59	0.44	0.99	0.04

Vinyl-insulated large ring terminals



Cat. no.	Wire range (AWG)	Max. ins. (in.)	Bolt hole (in.)	Rec. tool	Dimensions (in.)				Stock thick. (in.)
					A	B	C	M	
RDV167	8	0.340	#8	ERG4007	1.36	0.42	0.28	1.17	0.04
RDV367	8	0.340	#10	ERG4007	1.36	0.42	0.28	1.17	0.04
RDV717	8	0.340	1/4	ERG4007	1.42	0.46	0.36	1.20	0.04
RDV727	8	0.340	5/16	ERG4007	1.51	0.57	0.36	1.23	0.04
RDV737	8	0.340	3/8	ERG4007	1.51	0.57	0.36	1.23	0.04
RDV757*	8	0.340	1/2	TBM6S	1.67	0.82	0.55	1.27	0.04
REV267	6	0.390	#10	ERG4007	1.48	0.45	0.28	1.23	0.04
REV717	6	0.390	1/4	ERG4007	1.48	0.49	0.28	1.23	0.04
REV727	6	0.390	5/16	ERG4007	1.59	0.61	0.34	1.30	0.04
REV737	6	0.390	3/8	ERG4007	1.59	0.61	0.34	1.30	0.04
REV757*	6	0.390	1/2	TBM6S	1.66	0.82	0.55	1.26	0.04

*Brazed seam

Diagram

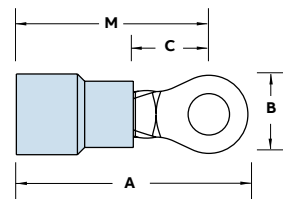

Ring terminals

Non-insulated ring terminals



Constructed of electrolytic copper for high conductivity.



Cat. no.	Pkg. qty.	Wire range (AWG)	Bolt hole (in.)	Rec. tool	Dimensions (in.)				Stock thick. (in.)
					A	B	C	M	
A18-4	100	22-16	#4	ERG4002	0.75	0.31	0.27	0.59	0.03
A18-6	100	22-16	#6		0.72	0.25	0.27	0.59	0.03
A85	1,000	22-16	#6		0.72	0.25	0.27	0.59	0.03
A18-8	100	22-16	#8		0.75	0.31	0.27	0.59	0.03
A86	1,000	22-16	#8		0.75	0.31	0.27	0.59	0.03
A18-10	100	22-16	#10		0.75	0.31	0.27	0.59	0.03
A87	1,000	22-16	#10		0.75	0.31	0.27	0.59	0.03
A18-14	100	22-16	¼		0.92	0.50	0.37	0.67	0.03
A71	1,000	22-16	¼		0.92	0.50	0.37	0.67	0.03
A18-516	100	22-16	⅝		0.92	0.50	0.37	0.67	0.03
A72	1,000	22-16	⅝		0.92	0.50	0.37	0.67	0.03
A18-38	100	22-16	⅜		0.99	0.54	0.35	0.67	0.03
A73	1,000	22-16	⅜		0.99	0.54	0.35	0.67	0.03
A18-12	100	22-16	½		1.06	0.72	0.38	0.70	0.03
A75	1,000	22-16	½		1.06	0.72	0.38	0.70	0.03
B14-4	100	18-14	#4	ERG4002	0.72	0.25	0.27	0.59	0.03
B132	1,000	18-14	#4	ERG4005	0.72	0.25	0.27	0.59	0.03
B14-6	100	18-14	#6		0.72	0.25	0.27	0.59	0.03
B133	1,000	18-14	#6		0.72	0.25	0.27	0.59	0.03
B14-8	100	18-14	#8		0.75	0.31	0.27	0.59	0.03
B86	1,000	18-14	#8		0.75	0.31	0.27	0.59	0.03
B14-10	100	18-14	#10		0.75	0.31	0.27	0.59	0.03
B87	1,000	18-14	#10		0.75	0.31	0.27	0.59	0.03
B14-14	100	18-14	¼		0.93	0.50	0.38	0.68	0.03



Cat. no.	Pkg. qty.	Wire range (AWG)	Bolt hole (in.)	Rec. tool	Dimensions (in.)				Stock thick. (in.)
					A	B	C	M	
B71	1,000	18-14	¼	ERG4002	0.93	0.50	0.38	0.68	0.03
B14-516	100	18-14	⅝	ERG4005	0.93	0.50	0.38	0.68	0.03
B72	1,000	18-14	⅝		0.93	0.50	0.38	0.68	0.03
B14-38	100	18-14	⅜		0.96	0.54	0.35	0.68	0.03
B73	1,000	18-14	⅜		0.96	0.54	0.35	0.68	0.03
B14-12	100	18-14	½		1.06	0.72	0.38	0.70	0.03
B75-TB	1,000	18-14	½		1.06	0.72	0.38	0.70	0.03
B85	1,000	18-14	#6		0.75	0.31	0.27	0.59	0.03
B134	1,000	18-14	#8		0.72	0.25	0.27	0.59	0.03
C10-6-SK	50	12-10	#6	ERG4002	0.82	0.31	0.27	0.66	0.04
C33	500	12-10	#6	ERG4005	0.82	0.31	0.27	0.66	0.04
C10-8-SK	50	12-10	#8		0.82	0.31	0.27	0.66	0.04
C77	500	12-10	#8		0.82	0.31	0.27	0.66	0.04
C10-10	50	12-10	#10		0.85	0.38	0.27	0.66	0.04
C26	500	12-10	#10		0.85	0.38	0.27	0.66	0.04
C36	500	12-10	#10		0.82	0.31	0.27	0.66	0.04
C10-14	50	12-10	¼		0.91	0.50	0.27	0.66	0.04
C71	500	12-10	¼		0.91	0.50	0.27	0.66	0.04
C10-516	50	12-10	⅝		0.98	0.50	0.38	0.73	0.04
C70	500	12-10	⅝		0.98	0.50	0.38	0.73	0.04
C72	500	12-10	⅝		1.10	0.59	0.45	0.80	0.04
C10-38	50	12-10	⅜		1.10	0.59	0.45	0.80	0.04
C73	500	12-10	⅜		1.10	0.59	0.45	0.80	0.04
C10-12	50	12-10	½		1.21	0.72	0.38	0.84	0.04
C75	500	12-10	½		1.21	0.72	0.38	0.84	0.04

Diagram

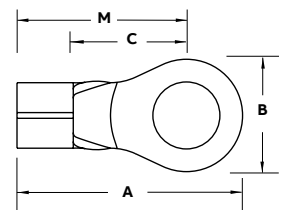

Ring terminals

Non-insulated large ring terminals — Brazed seam



Cat. no.	Pkg. qty.	Wire range (AWG)	Bolt hole (in.)	Rec. tool	Dimensions (in.)				Stock thick. (in.)
					A	B	C	M	
D8-10	25	8	#10	TBM6S	1.09	0.42	0.34	0.90	0.06
D36	200	8	#10	TBM6S	1.09	0.42	0.34	0.90	0.06
D26	200	8	#10	TBM6S	1.13	0.48	0.36	0.90	0.06
D8-14-SK	25	8	¼	TBM6S	1.13	0.48	0.36	0.90	0.06
D71	200	8	¼	TBM6S	1.13	0.48	0.36	0.90	0.06
D8-516	25	8	⅝	TBM6S	1.32	0.59	0.49	1.03	0.06
D72	200	8	⅝	TBM6S	1.32	0.59	0.49	1.03	0.06
D8-38	25	8	⅜	TBM6S	1.32	0.59	0.49	1.03	0.06
D73	200	8	⅜	TBM6S	1.32	0.59	0.49	1.03	0.06
D8-12	25	8	½	TBM6S	1.49	0.82	0.55	1.09	0.06
D75	200	8	½	TBM6S	1.49	0.82	0.55	1.09	0.06
E6-10	20	6	#10	TBM6S	1.13	0.48	0.36	0.90	0.06
E26	200	6	#10	TBM6S	1.13	0.48	0.36	0.90	0.06
E6-14	20	6	¼	TBM6S	1.13	0.48	0.36	0.90	0.06
E71	200	6	¼	TBM6S	1.13	0.48	0.36	0.90	0.06
E6-516	20	6	⅝	TBM6S	1.32	0.60	0.49	1.03	0.06
E72	200	6	⅝	TBM6S	1.32	0.60	0.49	1.03	0.06
E6-38	20	6	⅜	TBM6S	1.32	0.60	0.49	1.03	0.06
E73	200	6	⅜	TBM6S	1.32	0.60	0.49	1.03	0.06
E6-12	20	6	½	TBM6S	1.49	0.82	0.55	1.08	0.06
E75	200	6	½	TBM6S	1.49	0.82	0.55	1.08	0.06
F4-10	20	4	#10	TBM6S	1.16	0.48	0.36	0.93	0.07
F26	200	4	#10	TBM6S	1.16	0.48	0.36	0.93	0.07
F4-14	20	4	¼	TBM6S	1.16	0.48	0.36	0.93	0.07
F71-TB	200	4	¼	TBM6S	1.16	0.48	0.36	0.93	0.07
F4-516	20	4	⅝	TBM6S	1.35	0.60	0.49	1.06	0.07
F72	200	4	⅝	TBM6S	1.35	0.60	0.49	1.06	0.07
F4-38	20	4	⅜	TBM6S	1.35	0.60	0.49	1.06	0.07
F73	200	4	⅜	TBM6S	1.35	0.60	0.49	1.06	0.07
F4-12	20	4	½	TBM6S	1.52	0.82	0.55	1.11	0.07
F75	200	4	½	TBM6S	1.52	0.82	0.55	1.11	0.07

Diagram

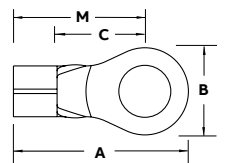

Ring terminals

Non-insulated large ring terminals — Tubular



Cat. no.	Pkg. qty.	Wire range (AWG)	Bolt hole (in.)	Rec. tool	Dimensions (in.)				Stock thick. (in.)
					A	B	C	M	
D10161	200	8/8AN	#8	ERG4005	1.15	0.41	0.28	0.95	0.04
D10361	200	8/8AN	#10	ERG4008	1.15	0.41	0.28	0.95	0.04
D10711	200	8/8AN	¼		1.20	0.45	0.36	0.97	0.04
D10721	200	8/8AN	⅝		1.28	0.56	0.36	1.00	0.04
D10731	200	8/8AN	¾		1.28	0.56	0.36	1.00	0.04
D975*	200	8/8AN	½	TBM6S	1.46	0.83	0.49	1.06	0.04
E10261	200	6/6AN	#10	ERG4005	1.26	0.49	0.24	1.02	0.04
E10711	200	6/6AN	¼	ERG4008	1.26	0.49	0.27	0.99	0.04
E10721	200	6/6AN	⅝		1.38	0.60	0.34	1.04	0.04
E10731	200	6/6AN	¾		1.38	0.60	0.34	1.04	0.04
F10261	100	4/4AN	#10	ERG4008	1.37	0.55	0.30	1.07	0.04
F10711	100	4/4AN	¼		1.37	0.55	0.30	1.07	0.04
F10721	100	4/4AN	⅝		1.42	0.62	0.34	1.08	0.04
F10731	100	4/4AN	¾		1.42	0.62	0.34	1.08	0.04
F975*	200	4/4AN	½	TBM6S	1.49	0.83	0.45	1.10	0.04
G926	100	2/2AN	#10	ERG4008	1.59	0.69	0.40	1.26	0.05
G2-14	10	2/2AN	¼	TBM6S	1.59	0.69	0.40	1.26	0.05
G971	100	2/2AN	¼		1.59	0.69	0.40	1.26	0.05
G2-516	10	2/2AN	⅝		1.59	0.69	0.40	1.26	0.05
G972	100	2/2AN	⅝		1.59	0.69	0.40	1.26	0.05
G2-38	10	2/2AN	¾		1.59	0.69	0.40	1.26	0.05
G973	100	2/2AN	¾		1.59	0.69	0.40	1.26	0.05
G2-12	10	2/2AN	½		1.79	0.80	0.49	1.36	0.05
G975	100	2/2AN	½		1.79	0.80	0.49	1.36	0.05

*Braze seam

AN – Aircraft wire



Cat. no.	Pkg. qty.	Wire range (AWG)	Bolt hole (in.)	Rec. tool	Dimensions (in.)				Stock thick. (in.)
					A	B	C	M	
H10-14	10	1AN-1/0	¼	ERG4008	1.65	0.77	0.43	1.32	0.05
H971	100	1AN-1/0	¼	TBM6S	1.65	0.77	0.43	1.32	0.05
H972	100	1AN-1/0	⅝		1.65	0.77	0.43	1.32	0.05
H973	100	1AN-1/0	¾		1.65	0.77	0.43	1.32	0.05
H975	100	1AN-1/0	½		1.85	0.77	0.54	1.41	0.05
J971	50	1/0AN-2/0	¼	TBM6S	1.94	0.84	0.48	1.53	0.06
J972	50	1/0AN-2/0	⅝		1.94	0.84	0.48	1.53	0.06
J20-38	10	1/0AN-2/0	¾		1.84	0.83	0.46	1.46	0.06
J973	50	1/0AN-2/0	¾		1.99	0.84	0.53	1.58	0.06
J974	50	1/0AN-2/0	⅞		1.99	0.89	0.51	1.56	0.06
J975	50	1/0AN-2/0	½		1.99	0.89	0.51	1.56	0.06
J976	50	1/0AN-2/0	⅝		1.99	0.89	0.51	1.56	0.06
K971	50	2/0AN-3/0	¼	TBM6S	2.08	0.93	0.54	1.69	0.06
K972	50	2/0AN-3/0	⅝		2.08	0.93	0.54	1.69	0.06
K30-38	5	2/0AN-3/0	¾		2.08	0.93	0.54	1.69	0.06
K973	50	2/0AN-3/0	¾		2.08	0.93	0.54	1.69	0.06
K974	50	2/0AN-3/0	⅞		2.08	0.93	0.54	1.70	0.06
K975	50	2/0AN-3/0	½		2.08	0.93	0.54	1.70	0.06
L971	50	3/0AN-4/0	¼	TBM6S	2.25	1.04	0.57	1.77	0.07
L972	50	3/0AN-4/0	⅝		2.25	1.04	0.57	1.77	0.07
L40-38	5	3/0AN-4/0	¾		2.25	1.04	0.57	1.77	0.07
L973	50	3/0AN-4/0	¾		2.25	1.04	0.57	1.77	0.07
L974	50	3/0AN-4/0	⅞		2.25	1.04	0.57	1.77	0.07
L975	50	3/0AN-4/0	½		2.25	1.04	0.57	1.77	0.07
M972	50	4/0AN-250	⅝	TBM6S	2.28	1.12	0.62	1.90	0.07
M250-38	5	4/0AN-250	¾		2.40	1.12	0.65	1.91	0.07
M973	50	4/0AN-250	¾		2.40	1.12	0.65	1.91	0.07
M974	50	4/0AN-250	⅞		2.40	1.12	0.65	1.91	0.07
M975	50	4/0AN-250	½		2.40	1.12	0.65	1.91	0.07

Diagram

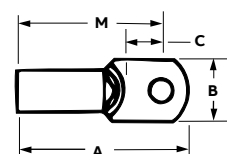

Ring terminals

Insulated heavy-duty ring terminals



Cat. no.	Pkg. qty.	Wire range (AWG)	Max. ins. (in.)	Bolt hole (in.)	Rec. tool	Dimensions (in.)				Stock thick. (in.)
						A	B	C	M	
Nylon										
RBC14-6	50	16-14 Heavy-duty	0.210	#6	WT2130A	0.98	0.25	0.29	0.85	0.05
RBC14-8	50	16-14 Heavy-duty	0.210	#8	WT2130A	1.04	0.39	0.29	0.85	0.05
RBC863	500	16-14 Heavy-duty	0.210	#8	WT2130A	1.04	0.39	0.29	0.85	0.05
RBC14-10	50	16-14 Heavy-duty	0.210	#10	WT2130A	1.04	0.39	0.29	0.85	0.05
RBC14-14	50	16-14 Heavy-duty	0.210	3/4	WT2130A	1.10	0.51	0.29	0.85	0.05
RBC713	500	16-14 Heavy-duty	0.210	3/4	WT2130A	1.10	0.51	0.29	0.85	0.05
RBC14-516	50	16-14 Heavy-duty	0.210	5/16	WT2130A	1.21	0.54	0.38	0.94	0.05
RBC14-38	50	16-14 Heavy-duty	0.210	3/8	WT2130A	1.26	0.63	0.38	0.94	0.05
RBC14-12	50	16-14 Heavy-duty	0.210	1/2	WT2130A	1.49	0.76	0.54	1.11	0.05
RBC753	500	16-14 Heavy-duty	0.210	1/2	WT2130A	1.49	0.76	0.54	1.11	0.05
Vinyl										
14RBC-6	50	16-14 Heavy-duty	0.210	#6	WT2130A	1.06	0.25	0.29	0.93	0.05
RBC857	500	16-14 Heavy-duty	0.210	#6	WT2130A	1.06	0.25	0.29	0.93	0.05
14RBC-8	50	16-14 Heavy-duty	0.210	#8	WT2130A	1.13	0.39	0.29	0.93	0.05
RBC867	500	16-14 Heavy-duty	0.210	#8	WT2130A	1.13	0.39	0.29	0.93	0.05
14RBC-10	50	16-14 Heavy-duty	0.210	#10	WT2130A	1.13	0.39	0.29	0.93	0.05
RBC877	500	16-14 Heavy-duty	0.210	#10	WT2130A	1.13	0.39	0.29	0.93	0.05
14RBC-14	50	16-14 Heavy-duty	0.210	3/4	WT2130A	1.19	0.51	0.29	0.93	0.05
RBC717	500	16-14 Heavy-duty	0.210	3/4	WT2130A	1.19	0.51	0.29	0.93	0.05
14RBC-516	50	16-14 Heavy-duty	0.210	5/16	WT2130A	1.29	0.54	0.38	1.03	0.05
RBC727	500	16-14 Heavy-duty	0.210	5/16	WT2130A	1.29	0.54	0.38	1.03	0.05
14RBC-38	50	16-14 Heavy-duty	0.210	3/8	WT2130A	1.34	0.63	0.38	1.03	0.05
RBC797	500	16-14 Heavy-duty	0.210	3/8	WT2130A	1.34	0.63	0.38	1.03	0.05
14RBC-12	50	16-14 Heavy-duty	0.210	1/2	WT2130A	1.57	0.76	0.54	1.19	0.05

Diagram

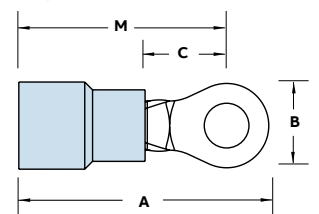

Ring terminals

Non-insulated heavy-duty ring terminals



Cat. no.	Pkg. qty.	Wire range (AWG)	Bolt hole (in.)	Rec. tool	Dimensions (in.)				Stock thick. (in.)
					A	B	C	M	
BC14-6	50	16-14 Heavy-duty	#6	ERG4002, ERG4005	0.81	0.25	0.29	0.68	0.05
BC85	500	16-14 Heavy-duty	#6	ERG4002, ERG4005	0.81	0.25	0.29	0.68	0.05
BC14-8	50	16-14 Heavy-duty	#8	ERG4002, ERG4005	0.87	0.39	0.29	0.68	0.05
BC86	500	16-14 Heavy-duty	#8	ERG4002, ERG4005	0.87	0.39	0.29	0.68	0.05
BC14-10	50	16-14 Heavy-duty	#10	ERG4002, ERG4005	0.87	0.39	0.29	0.68	0.05
BC87	500	16-14 Heavy-duty	#10	ERG4002, ERG4005	0.87	0.39	0.29	0.68	0.05
BC14-14	50	16-14 Heavy-duty	¼	ERG4002, ERG4005	0.93	0.51	0.29	0.68	0.05
BC71	500	16-14 Heavy-duty	¼	ERG4002, ERG4005	0.93	0.51	0.29	0.68	0.05
BC14-516	50	16-14 Heavy-duty	⅝	ERG4002, ERG4005	1.04	0.54	0.38	0.77	0.05
BC72	500	16-14 Heavy-duty	⅝	ERG4002, ERG4005	1.04	0.54	0.38	0.77	0.05
BC14-38	50	16-14 Heavy-duty	⅜	ERG4002, ERG4005	1.09	0.63	0.38	0.77	0.05
BC79	500	16-14 Heavy-duty	⅜	ERG4002, ERG4005	1.09	0.63	0.38	0.77	0.05
BC14-12	50	16-14 Heavy-duty	½	ERG4002, ERG4005	1.32	0.76	0.54	0.94	0.05
BC75	500	16-14 Heavy-duty	½	ERG4002, ERG4005	1.32	0.76	0.54	0.94	0.05

Diagram

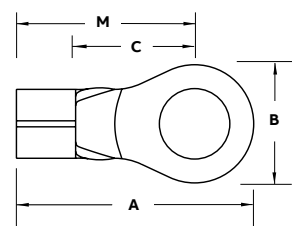

Ring terminals

High-temperature non-insulated and Tefzel insulated rings



High-temperature non-insulated rings — 1200 °F max.



Diagram	Cat. no.	Pkg. qty.	Wire range (AWG)	Max. ins. (in.)	Bolt hole (in.)	Rec. tool	Dimensions (in.)				Stock thick. (in.)
							A	B	C	M	
	NW18-10	100	20-18	2.5	#10	WT1377	0.63	0.31	0.28	0.38	0.032
	NW52	1,000	20-18	2.5	#8	WT1377	0.63	0.31	0.28	0.38	0.032
	NW81	1,000	16-14	2.5	#6	WT1377	0.66	0.31	0.28	0.51	0.040
	NW14-8	100	16-14	2.5	#8	WT1377	0.66	0.31	0.28	0.51	0.040
	NW14-10	100	16-14	2.5	#10	WT1377	0.66	0.31	0.28	0.51	0.040
	NW83	1,000	16-14	2.5	#10	WT1377	0.66	0.31	0.28	0.51	0.040
	NW14-12	100	16-14	2.5	#12*	WT1377	0.66	0.31	0.28	0.51	0.040
	NW84	1,000	16-14	2.5	#12*	WT1377	0.66	0.31	0.28	0.51	0.040
	NW10-8	50	12-10	3	#8	WT1377	0.66	0.31	0.2	0.51	0.040
	NW10-10	50	12-10	3	#10	WT1377	0.66	0.31	0.2	0.51	0.040
	NW10-12	50	12-10	3	#12*	WT1377	0.66	0.31	0.2	0.51	0.040

* #12 stud is smaller than 1/4 in. stud



Tefzel insulated rings — Insulation grip



Diagram	Cat. no.	Pkg. qty.	Wire range (AWG)	Max. ins. (in.)	Bolt hole (in.)	Rec. tool	Dimensions (in.)				Stock thick. (in.)
							A	B	C	M	
	RAT853	1,000	22-18	0.140	#6	WT145C	0.81	0.25	0.25	0.69	0.03
	RAT863	1,000	22-18	0.140	#8	WT145C	0.84	0.31	0.25	0.69	0.03
	RAT873	1,000	22-18	0.140	#10	WT145C	0.84	0.31	0.25	0.69	0.03
	RAT713	1,000	22-18	0.140	1/4	WT145C	1.07	0.46	0.31	0.84	0.03
	RBT853	1,000	16-14	0.170	#6	WT145C	0.84	0.31	0.25	0.69	0.03
	RBT863	1,000	16-14	0.170	#8	WT145C	0.84	0.31	0.25	0.69	0.03
	RBT873	1,000	16-14	0.170	#10	WT145C	0.84	0.31	0.25	0.69	0.03
	RBT713	1,000	16-14	0.170	1/4	WT145C	1.08	0.46	0.31	0.81	0.03
	RCT333	500	12-10	0.210	#6	WT145C	1.00	0.37	0.27	0.81	0.04
	RCT863	500	12-10	0.210	#8	WT145C	1.00	0.37	0.27	0.81	0.04
	RCT363	500	12-10	0.210	#10	WT145C	1.00	0.37	0.27	0.81	0.04
	RCT713	500	12-10	0.210	1/4	WT145C	1.11	0.52	0.32	0.85	0.04
	RCT703	500	12-10	0.210	3/16	WT145C	1.23	0.52	0.31	0.96	0.04
	RCT733	500	12-10	0.210	3/8	WT145C	1.29	0.58	0.35	1.00	0.04

Tefzel is a registered trademark of DuPont

Ring terminals

Nylon-insulated rectangular rings



Cat. No.	Pkg. Qty.	Bolt Hole	Wire range (AWG)	Rec. Tool	Dimensions (in.)				BU-Ships tongue shape	Stock thick. (in.)
					A	B	C	M		
RA486	1,000	#4	22-18	ERG4001	0.796	0.237	0.237	0.143	L86P-1	0.03
RA485	1,000	#4	22-18	ERG4001	1.015	0.237	0.404	0.195	L85P-1	0.03
RA483	1,000	#5	22-18	ERG4001	0.859	0.277	0.277	0.143	L83P-1	0.03
RA484	1,000	#6	22-18	ERG4001	1.015	0.237	0.404	0.195	L84P-1	0.03
RA481	1,000	#6	22-18	ERG4001	1.109	0.302	0.465	0.227	L81P-1	0.03
RA482	1,000	#8	22-18	ERG4001	1.109	0.302	0.465	0.227	L82P-1	0.03
RA480*	1,000	#8	22-18	ERG4001	1.359	0.390	0.621	0.310	L80P-1	0.03
RB486	1,000	#4	16-14	ERG4001	0.796	0.237	0.237	0.143	L86P-2	0.03
RB485	1,000	#4	16-14	ERG4001	1.015	0.237	0.404	0.195	L85P-2	0.03
RB483	1,000	#5	16-14	ERG4001	0.859	0.277	0.277	0.143	L83P-2	0.03
RB484	1,000	#6	16-14	ERG4001	1.015	0.237	0.404	0.195	L84P-2	0.03
RB481	1,000	#6	16-14	ERG4001	1.109	0.302	0.465	0.227	L81P-2	0.03
RB482	1,000	#8	16-14	ERG4001	1.109	0.302	0.465	0.227	L82P-2	0.03
RB480*	1,000	#8	16-14	ERG4001	1.359	0.390	0.621	0.310	L80P-2	0.03
RC486	500	#4	12-10	ERG4001	0.984	0.237	0.237	0.143	L86P-3	0.04
RC485	500	#4	12-10	ERG4001	1.187	0.237	0.404	0.195	L85P-3	0.04
RC483	500	#5	12-10	ERG4001	1.046	0.277	0.277	0.143	L83P-3	0.04
RC484	500	#6	12-10	ERG4001	1.203	0.237	0.404	0.195	L84P-3	0.04
RC481	500	#6	12-10	ERG4001	1.281	0.302	0.465	0.227	L81P-3	0.04
RC482	500	#8	12-10	ERG4001	1.281	0.302	0.465	0.227	L82P-3	0.04
RC480*	500	#8	12-10	ERG4001	1.531	0.390	0.621	0.310	L80P-3	0.04

* Not available on tape.

Note: RA, RB, RC486 for use with BU-Ships terminal board types 26TB. RA, RB, RC485 for use with 25TB and 27TB. RA, RB, RC483 for use with 8TB. RA, RB, RC484 for use with 10TB and 11TB. RA, RB, RC481 for use with 6TB, 7TB and 9TB. RA, RB, RC482 for use with 15TB. RA, RB, RC480 for use with 3TB, 4TB, 5TB, 16TB, 17TB and 18TB.

Note:
22-18 ga. = 1-2 Navy
16-14 ga. = 2-1/2-4 Navy
12-10 ga. = 6-9 Navy

Diagram

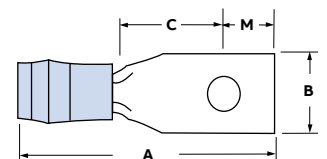

Ring terminals

Non-insulated rectangular rings



Cat. no.	Pkg. qty.	Bolt hole	Wire range (AWG)	Rec. Tool	Dimensions (in.)				BU-Ships tongue shape	Stock thick. (in.)
					A	B	C	M		
A486	1,000	#4	22-18	ERG4002	0.65	0.237	0.237	0.143	L86	0.03
A485	1,000	#4	22-18	ERG4002	0.87	0.237	0.404	0.195	L85	0.03
A483	1,000	#5	22-18	ERG4002	0.70	0.277	0.277	0.143	L83	0.03
A484	1,000	#6	22-18	ERG4002	0.87	0.237	0.404	0.195	L84	0.03
A481	1,000	#6	22-18	ERG4002	0.96	0.302	0.465	0.227	L81	0.03
A482	1,000	#8	22-18	ERG4002	0.96	0.302	0.465	0.227	L82	0.03
A480*	1,000	#8	22-18	ERG4002	1.21	0.390	0.621	0.310	L80	0.03
B486	1,000	#4	16-14	ERG4002, ERG4005	0.65	0.237	0.237	0.143	L86	0.03
B485	1,000	#4	16-14	ERG4002, ERG4005	0.87	0.237	0.404	0.195	L85	0.03
B483	1,000	#5	16-14	ERG4002, ERG4005	0.70	0.277	0.277	0.143	L83	0.03
B484	1,000	#6	16-14	ERG4002, ERG4005	0.87	0.237	0.404	0.195	L84	0.03
B481	1,000	#6	16-14	ERG4002, ERG4005	0.96	0.302	0.465	0.227	L81	0.03
B482	1,000	#8	16-14	ERG4002, ERG4005	0.96	0.302	0.465	0.227	L82	0.03
B480*	1,000	#8	16-14	ERG4002, ERG4005	1.21	0.390	0.621	0.310	L80	0.03
C486	500	#4	12-10	ERG4002, ERG4005	0.73	0.237	0.237	0.143	L86	0.04
C485	500	#4	12-10	ERG4002, ERG4005	0.90	0.237	0.404	0.195	L85	0.04
C483	500	#5	12-10	ERG4002, ERG4005	0.76	0.277	0.277	0.143	L83	0.04
C484	500	#6	12-10	ERG4002, ERG4005	0.94	0.237	0.404	0.195	L84	0.04
C481	500	#6	12-10	ERG4002, ERG4005	1.03	0.302	0.465	0.227	L81	0.04
C482	500	#8	12-10	ERG4002, ERG4005	1.03	0.302	0.465	0.227	L82	0.04
C480*	500	#8	12-10	ERG4002, ERG4005	1.27	0.390	0.621	0.310	L80	0.04

* Not available on tape.

Note: A, B, C486 for use with BU-Ships terminal board types 26TB. A, B, C485 for use with 25TB, 27TB. A, B, C483 for use with 8TB. A, B, C484 for use with 10TB and 11TB. A, B, C481 for use with 6TB, 7TB and 9TB. A, B, C482 for use with 15TB. A, B, C480 for use with 3TB, 5TB, 16TB, 17TB and 18TB.

Note:
 22-18 ga. = 1-2 Navy
 16-14 ga. = 2-1/2-4 Navy
 12-10 ga. = 6-9 Navy

Diagram

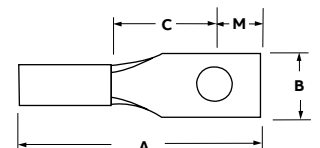

Flag terminals

Non-insulated flags

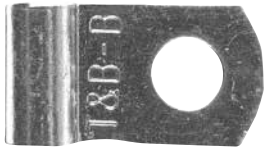

Cat. no.	Pkg. qty.	Wire range (AWG)	Bolt hole (in.)	Rec. tool	Dimensions (in.)				Stock thick. (in.)
					A	B	C	M	
AB14-6A	100	22-14	#6	ERG4004	0.55	0.31	0.22	0.39	0.03
AB51	1,000	22-14	#6	ERG4004	0.55	0.31	0.22	0.39	0.03
AB14-8A	100	22-14	#8	ERG4004	0.55	0.31	0.22	0.39	0.03
AB52	1,000	22-14	#8	ERG4004	0.55	0.31	0.22	0.39	0.03
AB14-10A	100	22-14	#10	ERG4004	0.55	0.31	0.22	0.39	0.03
AB53	1,000	22-14	#10	ERG4004	0.55	0.31	0.22	0.39	0.03
C51	500	12-10	#6	ERG4004	0.66	0.31	0.25	0.48	0.04
C10-8A	50	12-10	#8	ERG4004	0.66	0.31	0.25	0.48	0.04
C52-TB	500	12-10	#8	ERG4004	0.66	0.31	0.25	0.48	0.04
C10-10A	50	12-10	#10	ERG4004	0.66	0.31	0.25	0.48	0.04
C53	500	12-10	#10	ERG4004	0.66	0.31	0.25	0.48	0.04
D236	200	8	#10	WT129	0.83	0.50	0.25	0.59	0.06
D226	200	8	#10	WT129	0.90	0.50	0.29	0.64	0.06
D271	200	8	¼	WT129	0.92	0.50	0.33	0.68	0.06
E226	200	6	#10	WT129	0.93	0.50	0.29	0.69	0.06
E271	200	6	¼	WT129	0.99	0.50	0.33	0.73	0.06
E272	200	6	⅜	WT129	1.05	0.50	0.41	0.81	0.06
F226	200	4	#10	WT129	1.07	0.56	0.33	0.80	0.07
F271	200	4	¼	WT129	1.10	0.63	0.33	0.80	0.07
F272	200	4	⅜	WT129	1.18	0.63	0.41	0.88	0.07
F273	200	4	⅝	WT129	1.20	0.63	0.43	0.90	0.07
G671	100	2	¼	WT129	1.20	0.63	0.33	0.89	0.08
G672	100	2	⅜	WT129	1.28	0.63	0.41	0.97	0.08
G673	100	2	⅝	WT129	1.32	0.63	0.46	1.02	0.08
H672	50	1/0	⅜	13642M	1.31	0.63	0.41	1.01	0.10
H673	50	1/0	⅝	13642M	1.36	0.63	0.46	1.06	0.10
J672	50	2/0	⅜	13642M	1.46	0.75	0.41	1.10	0.10
J673	50	2/0	⅝	13642M	1.51	0.75	0.46	1.15	0.10
J675	50	2/0	½	13642M	1.67	0.75	0.55	1.24	0.10
K672	50	3/0	⅜	13642M	1.59	0.81	0.41	1.19	0.11
K673	50	3/0	⅝	13642M	1.64	0.81	0.46	1.24	0.11
K675	50	3/0	½	13642M	1.76	0.81	0.55	1.34	0.11
M673	50	250 kcmil	⅜	13642M	1.89	1.0	0.46	1.43	0.13
M675	50	250 kcmil	½	13642M	1.99	1.0	0.55	1.52	0.13

Diagram

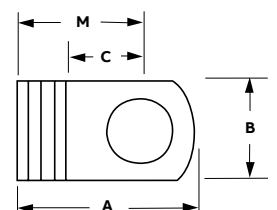

Fork terminals

Nylon-insulated forks



- Fork terminals enable easy installation because the mounting screw does not have to be completely removed
- Brazed-seam barrel is serrated for high pull-out value
- Terminal is high-conductivity electrolytic copper, electro-tin plated
- Insulation is colour-coded
- Vinyl-insulated fork terminals have extra-long PVC insulation sleeve for protection and stress relief at wire's flex point



Diagram	Cat. no.	Pkg. qty.	Wire range (AWG)	Max. ins. (in.)	Bolt hole (in.)	Rec. tool	Dimensions (in.)				Stock thick. (in.)
							A	B	C	M	
	RA18-6F	100	22-16	0.136	#6	ERG4001	0.83	0.25	0.25	0.71	0.02
	RA1103	1,000	22-16	0.136	#6	ERG4001	0.83	0.25	0.25	0.71	0.02
	RA18-8F	100	22-16	0.136	#8	ERG4001	0.86	0.31	0.25	0.71	0.02
	RA1123	1,000	22-16	0.136	#8	ERG4001	0.86	0.31	0.25	0.71	0.02
	RA18-10F	100	22-16	0.136	#10	ERG4001	0.86	0.31	0.25	0.71	0.02
	RA1153	1,000	22-16	0.136	#10	ERG4001	0.86	0.31	0.25	0.71	0.02
	RA18-14F	100	22-16	0.136	¼	ERG4001	0.95	0.44	0.31	0.70	0.02
	RA1163	1,000	22-16	0.136	¼	ERG4001	0.95	0.44	0.31	0.70	0.02
	RB14-6F	100	18-14	0.162	#6	ERG4001	0.87	0.31	0.25	0.71	0.03
	RB1113	1,000	18-14	0.162	#6	ERG4001	0.87	0.31	0.25	0.71	0.03
	RB14-8F	100	18-14	0.162	#8	ERG4001	0.87	0.31	0.25	0.71	0.03
	RB1123	1,000	18-14	0.162	#8	ERG4001	0.87	0.31	0.25	0.71	0.03
	RB14-10F	100	18-14	0.162	#10	ERG4001	0.87	0.38	0.25	0.71	0.03
	RB1153	1,000	18-14	0.162	#10	ERG4001	0.87	0.38	0.25	0.71	0.03
	RB14-14F	100	18-14	0.162	¼	ERG4001	0.95	0.44	0.28	0.74	0.03
	RB1163	1,000	18-14	0.162	¼	ERG4001	0.95	0.44	0.28	0.74	0.03
	RB1103	1,000	18-14	0.162	#6	ERG4001	0.74	0.28	0.16	0.60	0.03
	RB1124	1,000	18-14	0.190	#8	ERG4001	0.95	0.31	0.25	0.79	0.03
	RB1154	1,000	18-14	0.190	#10	ERG4001	0.95	0.31	0.25	0.79	0.03
	RC10-6F	50	12-10	0.210	#6	ERG4001	0.97	0.31	0.27	0.81	0.04
	RC1113	500	12-10	0.210	#6	ERG4001	0.97	0.31	0.27	0.81	0.04
	RC10-8F	50	12-10	0.210	#8	ERG4001	1.00	0.37	0.27	0.81	0.04
	RC1123	500	12-10	0.210	#8	ERG4001	1.00	0.37	0.27	0.81	0.04
	RC10-10F	50	12-10	0.210	#10	ERG4001	1.00	0.37	0.27	0.81	0.04
	RC1153	500	12-10	0.210	#10	ERG4001	1.00	0.37	0.27	0.81	0.04
	RC10-14F	50	12-10	0.210	¼	ERG4001	1.12	0.50	0.27	0.86	0.04
	RC1163	500	12-10	0.210	¼	ERG4001	1.12	0.50	0.27	0.86	0.04
RC1124	500	12-10	0.250	#8	ERG4001	1.10	0.37	0.27	0.91	0.04	
RC1154	500	12-10	0.250	#10	ERG4001	1.10	0.37	0.27	0.91	0.04	

Add suffix "X" for wider wire entry to accommodate heavy wall insulation

Fork terminals

Nylon-insulated locking forks



Diagram	Cat. no.	Pkg. qty.	Wire range (AWG)	Max. ins. (in.)	Bolt hole (in.)	Rec. tool	Dimensions (in.)				Stock thick. (in.)
							A	B	C	M	
	RA18-6FL	100	22-16	0.136	#6	ERG4001	0.86	0.25	0.25	0.71	0.02
	RA2213	1,000	22-16	0.136	#6	ERG4001	0.86	0.25	0.25	0.71	0.02
	RA18-8FL	100	22-16	0.136	#8	ERG4001	0.86	0.29	0.25	0.71	0.02
	RA2243	1,000	22-16	0.136	#8	ERG4001	0.86	0.29	0.25	0.71	0.02
	RA18-10FL	100	22-16	0.136	#10	ERG4001	0.86	0.29	0.25	0.71	0.02
	RA2253	1,000	22-16	0.136	#10	ERG4001	0.86	0.29	0.25	0.71	0.02
	RB14-6FL	100	18-14	0.162	#6	ERG4001	0.87	0.25	0.25	0.71	0.03
	RB2213	1,000	18-14	0.162	#6	ERG4001	0.87	0.25	0.25	0.71	0.03
	RB2214	1,000	18-14	0.162	#6	ERG4001	0.95	0.25	0.25	0.79	0.03
	RB14-8FL	100	18-14	0.162	#8	ERG4001	0.87	0.29	0.25	0.71	0.03
	RB2233	1,000	18-14	0.162	#8	ERG4001	0.87	0.29	0.25	0.71	0.03
	RB14-10FL	100	18-14	0.162	#10	ERG4001	0.87	0.29	0.25	0.71	0.03
	RB2253	1,000	18-14	0.162	#10	ERG4001	0.87	0.29	0.25	0.71	0.03
	RB2254	1,000	18-14	0.190	#10	ERG4001	0.95	0.29	0.25	0.71	0.03
	RC10-6FL	50	12-10	0.210	#6	ERG4001	0.97	0.31	0.27	0.81	0.04
	RC2203	500	12-10	0.210	#6	ERG4001	0.97	0.31	0.27	0.81	0.04
	RC2204	1,000	12-10	0.250	#6	ERG4001	1.07	0.31	0.27	0.91	0.04
	RC10-8FL	50	12-10	0.210	#8	ERG4001	1.00	0.37	0.27	0.81	0.04
	RC2213	500	12-10	0.210	#8	ERG4001	1.00	0.37	0.27	0.81	0.04
	RC10-10FL	50	12-10	0.210	#10	ERG4001	1.00	0.37	0.27	0.81	0.04
	RC2223	500	12-10	0.210	#10	ERG4001	1.00	0.37	0.27	0.81	0.04
	RC2224	500	12-10	0.250	#10	ERG4001	1.10	0.37	0.27	0.91	0.04
	RC10-14FL	50	12-10	0.210	¼	ERG4001	1.12	0.50	0.32	0.86	0.04
	RC2233	500	12-10	0.210	¼	ERG4001	1.12	0.50	0.32	0.86	0.04

Fork terminals

Nylon- and vinyl-insulated forks



Nylon-insulated forks — Flanged tongue



Cat. no.	Pkg. qty.	Wire range (AWG)	Max. ins. (in.)	Bolt hole	Rec. tool	Dimensions (in.)				Stock thick. (in.)
						A	B	C	M	
RA18-6FS	100	22-16	0.136	#6	ERG4001	0.75	0.28	0.16	0.62	0.02
RA1203	1,000	22-16	0.136	#6	ERG4001	0.75	0.28	0.16	0.62	0.02
RA18-8FS	100	22-16	0.136	#8	ERG4001	0.89	0.31	0.23	0.65	0.02
RA1223	1,000	22-16	0.136	#8	ERG4001	0.89	0.31	0.23	0.65	0.02
RA18-10FS	100	22-16	0.136	#10	ERG4001	0.93	0.38	0.26	0.68	0.02
RA1253	1,000	22-16	0.136	#10	ERG4001	0.93	0.38	0.26	0.68	0.02
RB14-6FS	100	18-14	0.162	#6	ERG4001	0.74	0.28	0.16	0.60	0.03
RB1203	1,000	18-14	0.162	#6	ERG4001	0.74	0.28	0.16	0.60	0.03
RB14-8FS	100	18-14	0.162	#8	ERG4001	0.89	0.31	0.23	0.66	0.03
RB1223	1,000	18-14	0.162	#8	ERG4001	0.89	0.31	0.23	0.66	0.03
RB14-10FS	100	18-14	0.162	#10	ERG4001	0.94	0.38	0.27	0.69	0.03
RB1253	1,000	18-14	0.162	#10	ERG4001	0.94	0.38	0.27	0.69	0.03
RB1204	1,000	18-14	0.190	#6	ERG4001	0.79	0.28	0.16	0.67	0.03
RB1224	1,000	18-14	0.190	#8	ERG4001	0.94	0.31	0.23	0.71	0.03
RC10-8FS	50	12-10	0.210	#8	ERG4001	0.97	0.34	0.23	0.73	0.04
RC1223	500	12-10	0.210	#8	ERG4001	0.97	0.34	0.23	0.73	0.04
RC10-10FS	50	12-10	0.210	#10	ERG4001	1.00	0.38	0.26	0.74	0.04
RC1253	500	12-10	0.210	#10	ERG4001	1.00	0.38	0.26	0.74	0.04
RC1224	1,000	12-10	0.250	#8	ERG4001	1.08	0.34	0.23	0.80	0.04
RC1254	1,000	12-10	0.250	#10	ERG4001	1.12	0.38	0.26	0.86	0.04

Vinyl-insulated forks



Cat. no.	Pkg. qty.	Wire range (AWG)	Max. ins. (in.)	Bolt hole (in.)	Rec. tool	Dimensions (in.)				Stock thick. (in.)
						A	B	C	M	
18RA-6F	100	22-16	0.150	#6	ERG4001	0.94	0.25	0.27	0.81	0.02
RA1167	1,000	22-16	0.150	#6	ERG4001	0.94	0.25	0.27	0.81	0.02
18RA-8F	100	22-16	0.150	#8	ERG4001	0.97	0.31	0.27	0.81	0.02
RA1147	1,000	22-16	0.150	#8	ERG4001	0.97	0.31	0.27	0.81	0.02
18RA-10F	100	22-16	0.150	#10	ERG4001	0.97	0.31	0.27	0.81	0.02
RA1157	1,000	22-16	0.150	#10	ERG4001	0.97	0.31	0.27	0.81	0.02
14RB-6F	100	18-14	0.170	#6	ERG4001	0.97	0.31	0.27	0.81	0.03
RB647	1,000	18-14	0.170	#6	ERG4001	0.97	0.31	0.27	0.81	0.03
14RB-6FS	100	18-14	0.170	#6	ERG4001	0.89	0.30	0.25	0.75	0.03
14RB-8F	100	18-14	0.170	#8	ERG4001	0.97	0.31	0.27	0.81	0.03
RB657	1,000	18-14	0.170	#8	ERG4001	0.97	0.31	0.27	0.81	0.03
14RB-10F	100	18-14	0.170	#10	ERG4001	0.97	0.31	0.27	0.81	0.03
RB1157	1,000	18-14	0.170	#10	ERG4001	0.97	0.31	0.27	0.81	0.03
14RB-14F	100	18-14	0.170	3/4	ERG4001	1.11	0.44	0.38	0.89	0.03
RB1717	1,000	18-14	0.170	3/4	ERG4001	1.11	0.44	0.38	0.89	0.03
10RC-6F	50	12-10	0.210	#6	ERG4001	1.09	0.31	0.27	0.90	0.04
RC1337	500	12-10	0.210	#6	ERG4001	1.09	0.31	0.27	0.90	0.04
10RC-8F	50	12-10	0.210	#8	ERG4001	1.09	0.38	0.27	0.90	0.04
RC1147	500	12-10	0.210	#8	ERG4001	1.09	0.38	0.27	0.90	0.04
10RC-10F	50	12-10	0.210	#10	ERG4001	1.09	0.38	0.27	0.90	0.04
RC1157	500	12-10	0.210	#10	ERG4001	1.09	0.38	0.27	0.90	0.04
10RC-14F	50	12-10	0.210	3/4	ERG4001	1.15	0.50	0.37	0.90	0.04
RC1167	500	12-10	0.210	3/4	ERG4001	1.15	0.50	0.37	0.90	0.04

Diagram

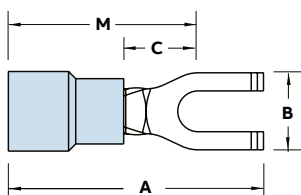

Diagram

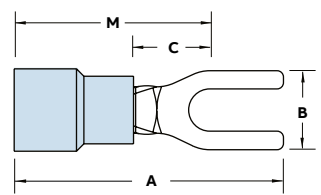

Fork terminals

Vinyl-insulated and non-insulated forks



Vinyl-insulated forks — Expanded insulation



Cat. no.	Pkg. qty.	Wire range (AWG)	Max. ins. (in.)	Bolt hole (in.)	Rec. tool	Dimensions (in.)				Stock thick. (in.)
						A	B	C	M	
18RA-6FX	100	22-16	0.170	#6	ERG4001	0.94	0.25	0.27	0.81	0.02
RA1167-170	1,000	22-16	0.170	#6	ERG4001	0.94	0.25	0.27	0.81	0.02
18RA-8FX	100	22-16	0.170	#8	ERG4001	0.97	0.31	0.27	0.81	0.02
RA1147-170	1,000	22-16	0.170	#8	ERG4001	0.97	0.31	0.27	0.81	0.02
18RA-10FX	100	22-16	0.170	#10	ERG4001	0.97	0.31	0.27	0.81	0.02
RA1157-170	1,000	22-16	0.170	#10	ERG4001	0.97	0.31	0.27	0.81	0.02
14RB-6FX	100	18-14	0.200	#6	ERG4001	0.97	0.31	0.27	0.81	0.03
RB647-200	1,000	18-14	0.200	#6	ERG4001	0.97	0.31	0.27	0.81	0.03
14RB-8FX	100	18-14	0.200	#8	ERG4001	0.97	0.31	0.27	0.81	0.03
RB657-200	1,000	18-14	0.200	#8	ERG4001	0.97	0.31	0.27	0.81	0.03
14RB-10FX	100	18-14	0.200	#10	ERG4001	0.97	0.31	0.27	0.81	0.03
RB1157-200	1,000	18-14	0.200	#10	ERG4001	0.97	0.31	0.27	0.81	0.03
10RC-8FX	50	12-10	0.250	#8	ERG4001	1.11	0.38	0.27	0.90	0.04
RC1147-250	500	12-10	0.250	#8	ERG4001	1.11	0.38	0.27	0.90	0.04
10RC-10FX	50	12-10	0.250	#10	ERG4001	1.11	0.38	0.27	0.90	0.04
RC1157-250	500	12-10	0.250	#10	ERG4001	1.11	0.38	0.27	0.90	0.04
10RC-14FX	50	12-10	0.250	¼	ERG4001	1.17	0.50	0.37	0.90	0.04

Non-insulated locking fork terminals



Cat. no.	Pkg. qty.	Wire range (AWG)	Bolt hole (in.)	Rec. tool	Dimensions (in.)				Stock thick. (in.)
					A	B	C	M	
A18-6F	100	22-16	#6	ERG4002	0.72	0.25	0.27	0.59	0.02
A116	1,000	22-16	#6		0.72	0.25	0.27	0.59	0.02
A18-8F	100	22-16	#8		0.75	0.31	0.27	0.59	0.02
A114	1,000	22-16	#8		0.75	0.31	0.27	0.59	0.02
A18-10F	100	22-16	#10		0.75	0.31	0.27	0.59	0.02
A115-TB	1,000	22-16	#10		0.75	0.31	0.27	0.59	0.02
B14-6F	100	18-14	#6	ERG4002	0.75	0.31	0.27	0.59	0.03
B64	1,000	18-14	#6	ERG4005	0.75	0.31	0.27	0.59	0.03
B19	1,000	18-14	#6		0.66	0.25	0.13	0.50	0.03
B14-8F	100	18-14	#8		0.75	0.31	0.27	0.59	0.03
B65-TB	1,000	18-14	#8		0.75	0.31	0.27	0.59	0.03
B14-10F	100	18-14	#10		0.75	0.31	0.27	0.59	0.03
B115	1,000	18-14	#10		0.75	0.31	0.27	0.59	0.03
B14-14F	100	18-14	¼		0.90	0.44	0.38	0.68	0.03
C10-6F	50	12-10	#6	ERG4002	0.77	0.31	0.27	0.63	0.04
C133	500	12-10	#6	ERG4005	0.77	0.31	0.27	0.63	0.04
C10-8F	50	12-10	#8		0.82	0.38	0.27	0.63	0.04
C114	500	12-10	#8		0.82	0.38	0.27	0.63	0.04
C10-10F	50	12-10	#10		0.82	0.38	0.27	0.63	0.04
C115	500	12-10	#10		0.82	0.38	0.27	0.63	0.04
C10-14F	50	12-10	¼		0.98	0.50	0.37	0.73	0.04
C116-TB	500	12-10	¼		0.98	0.50	0.37	0.73	0.04

Diagram

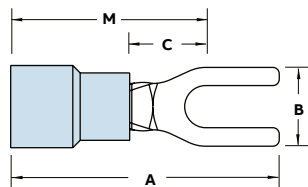

Diagram

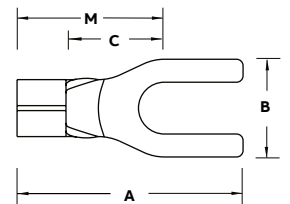

Fork terminals

Vinyl-insulated locking forks



Vinyl-insulated locking forks — Expanded insulation



Cat. no.	Pkg. qty.	Wire range (AWG)	Max. ins. (in.)	Bolt hole (in.)	Rec. tool	Dimensions (in.)				Stock thick. (in.)
						A	B	C	M	
18RA-6FLX	100	22-16	0.170	#6	ERG4001	0.97	0.25	0.25	0.81	0.02
RA2217-170	1,000	22-16	0.170	#6	ERG4001	0.97	0.25	0.25	0.81	0.02
18RA-8FLX	100	22-16	0.170	#8	ERG4001	0.97	0.29	0.25	0.81	0.02
18RA-10FLX	100	22-16	0.170	#10	ERG4001	0.97	0.29	0.25	0.81	0.02
RA2257-170	1,000	22-16	0.170	#10	ERG4001	0.97	0.29	0.25	0.81	0.02
14RB-6FLX	100	18-14	0.200	#6	ERG4001	0.97	0.31	0.27	0.81	0.03
RB2207-200	1,000	18-14	0.200	#6	ERG4001	0.97	0.31	0.27	0.81	0.03
RB2217-200	1,000	18-14	0.200	#6	ERG4001	0.97	0.29	0.27	0.81	0.03
14RB-8FLX	100	18-14	0.200	#8	ERG4001	0.97	0.31	0.27	0.81	0.03
RB2237-200	1,000	18-14	0.200	#8	ERG4001	0.97	0.31	0.27	0.81	0.03
14RB-10FLX	100	18-14	0.200	#10	ERG4001	0.97	0.31	0.27	0.81	0.03
RB2257-200	1,000	18-14	0.200	#10	ERG4001	0.97	0.31	0.27	0.81	0.03
10RC-6FLX	50	12-10	0.250	#6	ERG4001	1.07	0.31	0.27	0.91	0.04
RC2207-250	500	12-10	0.250	#6	ERG4001	1.07	0.31	0.27	0.91	0.04
10RC-8FLX	50	12-10	0.250	#8	ERG4001	1.10	0.37	0.27	0.91	0.04
10RC-10FLX	50	12-10	0.250	#10	ERG4001	1.10	0.37	0.27	0.91	0.04
RC2227-250	500	12-10	0.250	#10	ERG4001	1.10	0.37	0.27	0.91	0.04
10RC-14FLX	50	12-10	0.250	¼	ERG4001	1.22	0.50	0.32	0.96	0.04

Vinyl-insulated locking forks



Cat. no.	Pkg. qty.	Wire range (AWG)	Max. ins. (in.)	Bolt hole (in.)	Rec. tool	Dimensions (in.)				Stock thick. (in.)
						A	B	C	M	
18RA-6FL	100	22-16	0.150	#6	ERG4001	0.97	0.25	0.25	0.81	0.02
RA2217	1,000	22-16	0.150	#6	ERG4001	0.97	0.25	0.25	0.81	0.02
RA2227	1,000	22-16	0.150	#6	ERG4001	0.97	0.29	—	0.81	0.02
18RA-8FL	100	22-16	0.150	#8	ERG4001	0.97	0.29	0.25	0.81	0.02
RA2247	1,000	22-16	0.150	#8	ERG4001	0.97	0.29	0.25	0.81	0.02
18RA-10FL	100	22-16	0.150	#10	ERG4001	0.97	0.29	0.25	0.81	0.02
RA2257	1,000	22-16	0.150	#10	ERG4001	0.97	0.29	0.25	0.81	0.02
14RB-6FL	100	18-14	0.170	#6	ERG4001	0.97	0.25	0.27	0.81	0.03
RB2207	1,000	18-14	0.170	#6	ERG4001	0.97	0.25	0.27	0.81	0.03
RB2217	1,000	18-14	0.170	#6	ERG4001	0.97	0.29	0.27	0.81	0.03
14RB-8FL	100	18-14	0.170	#8	ERG4001	0.97	0.29	0.27	0.81	0.03
RB2237	1,000	18-14	0.170	#8	ERG4001	0.97	0.29	0.27	0.81	0.03
14RB-10FL	100	18-14	0.170	#10	ERG4001	0.97	0.29	0.27	0.81	0.03
RB2257	1,000	18-14	0.170	#10	ERG4001	0.97	0.29	0.27	0.81	0.03
10RC-6FL	50	12-10	0.220	#6	ERG4001	1.09	0.31	0.27	0.90	0.04
RC2207	500	12-10	0.220	#6	ERG4001	1.09	0.31	0.27	0.90	0.04
10RC-8FL	50	12-10	0.220	#8	ERG4001	1.09	0.37	0.27	0.90	0.04
RC2217	500	12-10	0.220	#8	ERG4001	1.09	0.37	0.27	0.90	0.04
10RC-10FL	50	12-10	0.220	#10	ERG4001	1.09	0.37	0.27	0.90	0.04
RC2227	500	12-10	0.220	#10	ERG4001	1.09	0.37	0.27	0.90	0.04
10RC-14FL	50	12-10	0.220	¼	ERG4001	1.09	0.49	0.27	0.90	0.04
RC2237	500	12-10	0.220	¼	ERG4001	1.09	0.49	0.27	0.90	0.04

Diagram

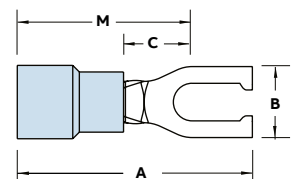

Fork terminals

Non-insulated locking forks



Cat. no.	Pkg. qty.	Wire range (AWG)	Bolt hole (in.)	Rec. tool	Dimensions (in.)				Stock thick. (in.)
					A	B	C	M	
A18-6FL	100	22-16	#6	ERG4002	0.75	0.25	0.27	0.59	0.02
A221	1,000	22-16	#6	ERG4002	0.75	0.25	0.27	0.59	0.02
A18-8FL	100	22-16	#8	ERG4002	0.75	0.29	0.27	0.59	0.02
A224	1,000	22-16	#8	ERG4002	0.75	0.29	0.27	0.59	0.02
A18-10FL	100	22-16	#10	ERG4002	0.75	0.29	0.27	0.59	0.02
A225	1,000	22-16	#10	ERG4002	0.75	0.29	0.27	0.59	0.02
B14-6FL	100	18-14	#6	ERG4002. ERG4005	0.75	0.25	0.27	0.59	0.03
B220	1,000	18-14	#6	ERG4002. ERG4005	0.75	0.25	0.27	0.59	0.03
B14-8FL	100	18-14	#8	ERG4002. ERG4005	0.75	0.29	0.27	0.59	0.03
B223	1,000	18-14	#8	ERG4002. ERG4005	0.75	0.29	0.27	0.59	0.03
B14-10FL	100	18-14	#10	ERG4002. ERG4005	0.75	0.29	0.27	0.59	0.03
B225	1,000	18-14	#10	ERG4002. ERG4005	0.75	0.29	0.27	0.59	0.03
C10-6FL	50	12-10	#6	ERG4002. ERG4005	0.85	0.31	0.27	0.66	0.04
C220-TB	500	12-10	#6	ERG4002. ERG4005	0.85	0.31	0.27	0.66	0.04
C10-8FL	50	12-10	#8	ERG4002. ERG4005	0.85	0.37	0.27	0.66	0.04
C221	500	12-10	#8	ERG4002. ERG4005	0.85	0.37	0.27	0.66	0.04
C10-10FL	50	12-10	#10	ERG4002. ERG4005	0.85	0.37	0.27	0.66	0.04
C222-TB	500	12-10	#10	ERG4002. ERG4005	0.85	0.37	0.27	0.66	0.04
C10-14FL	50	12-10	¼	ERG4002. ERG4005	0.85	0.49	0.27	0.66	0.04

Diagram

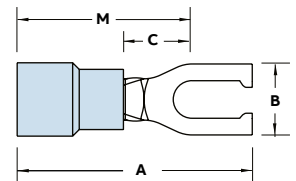

Pin terminals



- Provide an easy and effective way to terminate stranded wire into European/metric style terminal blocks
- Designed to prevent shorting, wire strand loss and/or wire pullout resulting from improper termination of stranded wire
- Designed to meet emerging global standards that require wire-to-metric style terminal block installations be terminated with a “pin” style terminal
- Available in vinyl-insulated, nylon-insulated and non-insulated styles
- All styles offered in 22 AWG to 10 AWG and compatible with existing Sta-Kon tooling



Cat. no.	Pkg. qty.	Wire range (AWG)	D (Dia.) (in.)	L (in.)	Rec. tool	Stock thick. (in.)
Non-insulated						
A47PT	1,000	22–18	0.075	0.63	ERG4002	0.02
B47PT	1,000	16–14	0.075	0.63	ERG4002	0.03
C55PT	500	12–10	0.106	0.76	ERG4002	0.04
Vinyl						
18RA-47PT	100	22–18	0.075	0.85	ERG4001	0.02
RA47PT	1,000	22–18	0.075	0.85	ERG4001	0.02
14RB-47PT	100	16–14	0.075	0.87	ERG4001	0.03
RB47PT	1,000	16–14	0.075	0.87	ERG4001	0.03
10RC-55PT	50	12–10	0.106	1.04	ERG4001	0.04
RC55PT	500	12–10	0.106	1.04	ERG4001	0.04
Nylon						
RA18-47PT	100	22–18	0.075	0.85	ERG4001	0.02
RA147PT	1,000	22–18	0.075	0.85	ERG4001	0.02
RB14-47PT	100	16–14	0.075	0.87	ERG4001	0.03
RB147PT	1,000	16–14	0.075	0.87	ERG4001	0.03
RC10-55PT	50	12–10	0.106	1.04	ERG4001	0.04
RC155PT	500	12–10	0.106	1.04	ERG4001	0.04

Diagrams

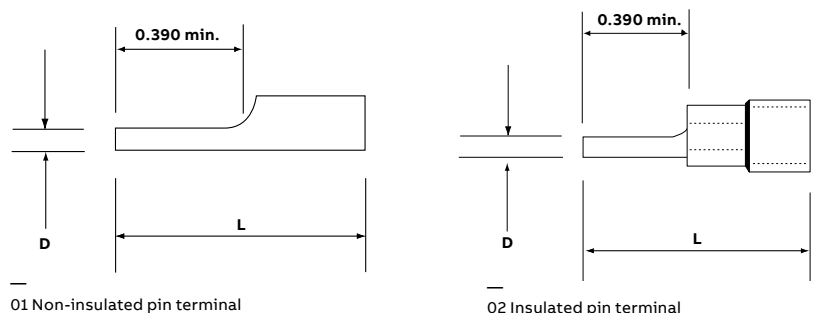

Butt splices



Vinyl-insulated butt splices — Expanded insulation



Diagram	Cat. no.	Pkg. qty.	Wire range (AWG)	Max. ins. (in.)	Rec. tool	Dimensions (in.)	
						A	B
	2RA18X	100	22-18	0.170	ERG4001	1.13	0.25
	RAA217-170	1,000	22-18	0.170	ERG4001	1.13	0.25
	RAA217	1,000	22-18	0.150	ERG4001	1.13	0.23
	2RB14X	100	16-14	0.200	ERG4001	1.13	0.26
	RBB217-200	1,000	16-14	0.200	ERG4001	1.13	0.26
	RBB217	1,000	16-14	0.170	ERG4001	1.13	0.24
	2RC10X	50	12-10	0.250	ERG4001	1.31	0.31
	RCC217-250	500	12-10	0.250	ERG4001	1.31	0.31
	RCC217	1,000	12-10	0.210	ERG4001	1.31	0.28

Note: RCC217 is not expanded



Nylon-insulated aircraft splices

Diagram	Cat. no.	Pkg. qty.	Wire range (AWG)	Rec. tool	Dimensions (in.)	
					A	B
	2RZZ	50	26-22	ERG4006	1.22	0.15
	RZZ23	500	26-22	ERG4006	1.22	0.15
	2RAA	50	22-18	ERG4001	1.52	0.25
	RAA23	500	22-18	ERG4001	1.52	0.25
	2RBB	50	16-14	ERG4001	1.52	0.28
	RBB23	500	16-14	ERG4001	1.52	0.28
	2RCC	25	12-10	ERG4001	1.54	0.35



Nylon-insulated butt splices



Diagram	Cat. no.	Pkg. qty.	Wire range (AWG)	Max ins. (in.)	Rec. tool	Dimensions (in.)	
						A	B
	2RA18	100	22-18	0.115	ERG4001	1.19	0.18
	RAA21	1,000	22-18	0.115	ERG4001	1.19	0.18
	2RB14	100	16-14	0.148	ERG4001	1.19	0.21
	RBB21	1,000	16-14	0.148	ERG4001	1.19	0.21
	2RC10	50	12-10	0.210	ERG4001	1.26	0.28
	RCC21	500	12-10	0.210	ERG4001	1.26	0.28
	2RD8	25	8	0.340	ERG4007. TBM6S	1.69	0.36
	RDD27	200	8	0.340	ERG4007. TBM6S	1.69	0.36
	2RE6	20	6	0.420	ERG4007. TBM6S	1.85	0.45
	REE28	200	6	0.420	ERG4007. TBM6S	1.85	0.45
	2RF4	15	4	0.510	TBM6S	1.85	0.52

Butt splices

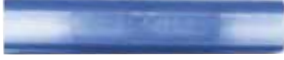

Tefzel insulated butt splices



Diagram	Cat. no.	Pkg. qty.	Max ins. (in.)	Wire range (AWG)	Rec. tool	Dimensions (in.)	
						A	B
	RAAT21	1,000	1.22	22-18	WT145C	1.22	0.115
	RBBT21	1,000	1.22	16-14	WT145C	1.22	0.148
	RCCT21	1,000	1.22	12-10	WT145C	1.22	0.210

Tefzel is a registered trademark of DuPont



Non-insulated butt splices



Diagram	Cat. no.	Pkg. qty.	Wire range (AWG)	Rec. tool	Dimensions (in.)	
					A	B
	2A-18	100	22-16	ERG4002	0.62	0.12
	AA2	1,000	22-16	ERG4002	0.62	0.12
	2B-14	100	18-14	ERG4002, ERG4005	0.62	0.16
	BB2	1,000	18-14	ERG4002, ERG4005	0.62	0.16
	2C-10	50	12-10	ERG4002, ERG4005	0.72	0.22
	CC2-TB	500	12-10	ERG4002, ERG4005	0.72	0.22
	2D-8	25	9-8-7	ERG4005, TBM6S	1.03	0.28
	DD102	200	9-8-7	ERG4005, TBM6S	1.03	0.28
	2E-6	20	6-5	ERG4005, TBM6S	1.12	0.37
	EE2	200	6-5	ERG4005, TBM6S	1.12	0.37
	2F-4	15	4-3	TBM6S	1.25	0.44
	FF2	200	4-3	TBM6S	1.25	0.44
	2G21	5	2-1	TBM6S	1.72	0.55
	GG2	25	2-1	TBM6S	1.72	0.55

Butt splices and parallel splices



Nylon-insulated butt splices



Diagram	Cat. no.	Pkg. qty.	Wire range (AWG)	Rec. tool	Dimensions (in.)	
					A	B
	2A20	100	22-18	ERG4001	0.84	0.20
	RAA24	1,000	22-18	ERG4001	0.84	0.20
	2B-16	100	18-16	ERG4001	0.84	0.23
	RBB25	1,000	18-16	ERG4001	0.84	0.23
	2C-12	50	14-12	ERG4001	0.90	0.28
	RCC26	500	14-12	ERG4001	0.90	0.28



- Wires are laid side by side in the connector, and the connection is made in one crimp
- Offers advantages in simplicity of installation and small size
- One crimp completes the splice

Parallel splices



Diagram	Cat. no.	Wire range (AWG)	CIR. mil range	Rec. tool	Length / A (in.)	O.D. / B (in.)	I.D. / C (in.)	Pkg. qty.
B14-PS-M	16-14	2,050-5,180	ERG4002	0.315	0.155	0.113	1 000	
C10-PS-D	12-10	5,180-13,100	ERG4005	0.380	0.220	0.170	500	
D8-PS-D	8	13,100-20,800	ERG4005	0.375	0.260	0.180	500	
E6-PS-D	6	20,800-33,100	WT115A	0.500	0.365	0.266	500	
F4-PS-W	4	33,100-52,600	WT115A	0.531	0.410	0.302	250	
G2-PS-W	2	52,600-83,700	WT115A	0.640	0.521	0.396	250	
H1/0-PS-C	1/0	83,700-119,500	TBM8-750M-1	0.750	0.571	0.446	100	
J2/0-PS-C	2/0	119,500-150,500	TBM8-750M-1	0.750	0.632	0.507	100	
K3/0-PS-L	3/0	150,500-190,000	TBM8-750M-1	0.750	0.701	0.564	50	
L4/0-PS-L	4/0	190,000-231,100	TBM8-750M-1	0.770	0.766	0.629	50	
M250-PS-Q	250 kcmil	231,100-300,000	TBM8-750M-1	1.063	0.926	0.749	25	
N300-PS-X	300 kcmil	300,000-380,000	TBM8-750M-1	1.125	1.100	0.882	10	
P400-PS-X	400 kcmil	380,000-478,000	TBM8-750M-1	1.250	1.200	0.956	10	
R500-PS-V	500 kcmil	478,000-600,000	TBM8-750M-1	1.438	1.330	1.060	5	

The total combined cross sectional area of all wires must be within the circular mil area range. Rated at 150 °C.

Wire joints

Crimp-on wire joints, one-piece nylon self-insulated



Cat. no.	Pkg. qty.	Wire range (AWG)		Rec. tool	Dimensions (in.)	
		Min.	Max.		A	B
RB44	100	2 #18	2 #16	WT2000	0.31	0.78
RB4-TB	1,000	2 #18	2 #16	WT2000	0.31	0.78
RC55	50	4 #18	2 #12	WT2130A	0.43	0.95
RC6	500	4 #18	2 #12	WT2130A	0.43	0.95
RP12	100	3 #14	4 #12	WT2130A	0.53	1.00
RP7	1,000	3 #14	4 #12	WT2130A	0.53	1.00

Cat. no.	Allowable wire combinations						
	#22	#20	#18	#16	#14	#12	#10
RB4-TB/ RB44	-	-	2-3	-	-	-	-
	-	-	1-2	2	-	-	-
	3	-	-	-	-	-	-
	-	3	-	-	-	-	-
	3	-	1	-	-	-	-
	2	3	-	-	-	-	-
	1-2	-	2	-	-	-	-
	2	-	-	1	-	-	-
	-	3	1	-	-	-	-
	1	2	-	-	-	-	-
	-	2	-	1	-	-	-
	-	1	2	-	-	-	-

Cat. no.	Allowable wire combinations						
	#22	#20	#18	#16	#14	#12	#10
RC6/RC55	-	-	1-4	-	-	1	-
	-	-	-	1-3	-	1	-
	-	-	-	-	1-2	1	-
	-	-	-	-	-	2	-
	-	-	3-5	-	1	-	-
	-	-	-	2-4	1	-	-
	-	-	-	-	3	-	-
	-	-	1-4	-	2	-	-
	-	-	-	1-3	2	-	-
	-	-	1-3	-	3	-	-
	-	-	-	1	3	-	-
	-	-	-	2-5	-	-	-
	-	-	4-6	-	-	-	-

Cat. no.	Allowable wire combinations						
	#22	#20	#18	#16	#14	#12	#10
RP7/RP12	-	-	-	-	-	-	2
	-	-	-	-	-	1	1
	-	-	-	-	1	-	1
	-	-	-	-	2-4	-	-
	-	-	-	-	2-4	1	-
	-	-	-	-	1-3	2	-
	-	-	-	-	1	3	-
	-	-	-	-	3-6	-	-
	-	-	-	-	1	2-3	-
	-	-	-	-	2	1-2	-
	-	-	-	-	3	1-2	-
	-	-	-	-	4	1	-

Diagram

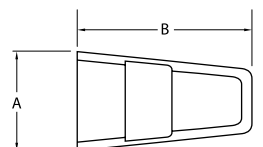

Wire joints

PT Series crimp-on wire joints

- 01 Two-piece barrel nylon insulator
- 02 Non-insulated barrel

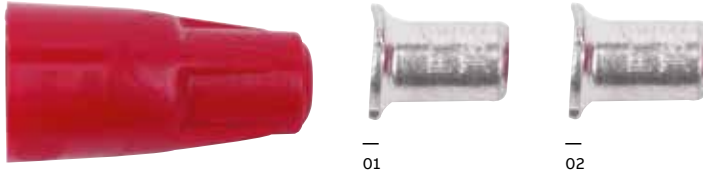

Diagrams	Cat. no.	Fig.	Pkg. qty.	Wire range (AWG)		Rec. tool	Dimensions (in.)	
				Min.	Max.		A	B
	PT66M	1	100	2 #18	3 #12 combination	WT161M	0.50	0.93
	PT6M	1	100	—	Insulator only	WT161M	0.50	0.93
	PT60M	1	100	2 #14	3 #12 connector only	WT161M	0.31	0.37
	PT70	2	200	2 #14	3 #12	WT161M	0.29	0.34
	PT70M	2	200	3 #18	4 #12	WT161M	0.31	0.37
	PT80	2	100	2 #16	4 #10	WT161M	0.35	0.62

90°C rated

- 01 Twist wires, insert through serrated barrel of wire joint (PT60M, PT70, PT70M, PT80).

Installation procedure for "PT" connectors

- 02 Crimp and trim off excess wire with WT161M hand tool.

- 03 Screw PT6M insulator firmly onto PT160M barrel.

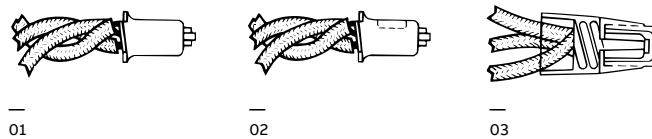

Wire joints

High-temperature wire joints



- Rated for temperatures up to 150 °C (302 °F), 600 V maximum
- Molded, one-piece nylon construction for electrical insulation, UL94-V2
- Brazed copper sleeve prevents separation of connection during crimping
- Internal serrations enable cold flow for increased conductivity and pull-out strength



Cat. no.	Pkg. qty.	Wire range (AWG)		Rec. tool	Dimensions (in.)	
		Min.	Max.		A	B
RB4-HT	1,000	2 #18	2 #16	WT2000	0.36	0.82
RB44-HT	100	2 #18	2 #16	WT2000	0.36	0.82
RC6-HT	500	3 #16	3 #14	ERG4001, WT2130A	0.48	0.95
RC551-HT	100	3 #16	3 #14	ERG4001, WT2130A	0.48	0.95
RP7-HT	500	3 #14	3 #12	ERG4007, WT2130A	0.53	1.00
RP12-HT	100	3 #14	3 #12	ERG4007, WT2130A	0.53	1.00

Wire joints UL listed combinations

Cat. no.	Solid or stranded AWG	Cat. no.	Solid or stranded AWG	
RB4-TB, RB44, RB4-10M	(2) or (3) #18	RP7, RP-12	(2) to (4) #12 AWG	
	(2) #16		(3) to (6) #14 AWG	
	(1) #16 and (1) or (2) #18		(3) #12 and (1) #14	
	(3) #22		(2) #12 and (1) #14	
	(3) #20		(2) #12 and (2) #14	
	(3) #22 and (1) #18		(2) #12 and (3) #14	
	(2) #22 and (3) #20		(1) #12 and (2) #14	
	(1) or (2) #22 and (2) #18		(1) #12 and (3) #14	
	(2) #22 and (1) #16		(1) #12 and (4) #14	
	(3) #20 and (1) #18		(2) #10	
	(2) #20 and (1) #22		(1) #10 and (1) #12	
	(2) #20 and (1) #16		(1) #10 and (1) #14	
	(1) #20 and (2) #18		(1) #8 Tor. and (1) #16	
	RC6, RC6-5M, RC55		(1) #14 with (2), (3) or (4) #16	(1) #10 and (1) #16
			(1) #14 with (3), (4) or (5) #18	(1) #12 and (1) #16
(2) #14 with (1), (2), (3) or (4) #18				
(2) #14 with (1), (2) or (3) #16				
(3) #14				
(4) to (7) #18				
(3) #14 with (1) or (2) #18				
(3) #14 with (1) #16				
(1) #12 with (1), (2), (3) or (4) #18				
(1) #12 with (1), (2) or (3) #16				
(1) #12 with (1) or (2) #14				
(5) #16				

Heat-shrinkable terminals, splices and disconnects



- These ring terminals, butt splices and disconnects are self-insulated with heat-shrinkable polyolefin and internally coated sealant
- Upon completed installation, a fully sealed connection is achieved to protect the joint against the degrading effects of galvanic action, corrosion and environmental exposure

Note: Not approved for outdoor use

Heat-shrinkable ring terminals



Diagram	Cat. no.	Pkg. qty.	Wire range (AWG)	Max. ins. (in.)	Bolt hole (in.)	Rec. tool	Dimensions (in.)				Stock thick. (in.)
							A	B	C	M	
	RAS18-6X	100	22-18	0.170	#6	ERG4255	1.23	0.25	0.27	1.10	0.03
	RAS18-8X	100	22-18	0.170	#8	ERG4255	1.26	0.31	0.27	1.10	0.03
	RAS18-10X	100	22-18	0.170	#10	ERG4255	1.26	0.31	0.27	1.10	0.03
	RBS14-6X	100	16-14	0.200	#6	ERG4255	1.23	0.25	0.27	1.10	0.03
	RBS14-8X	100	16-14	0.200	#8	ERG4255	1.23	0.25	0.27	1.10	0.03
	RBS14-10X	100	16-14	0.200	#10	ERG4255	1.26	0.31	0.27	1.10	0.03
	RCS10-6X	50	12-10	0.250	#6	ERG4255	1.34	0.31	0.27	1.15	0.04
	RCS10-8X	50	12-10	0.250	#8	ERG4255	1.34	0.37	0.27	1.15	0.04
	RCS10-10X	50	12-10	0.250	#10	ERG4255	1.34	0.37	0.27	1.15	0.04
	RCS10-14X	50	12-10	0.250	¼	ERG4255	1.34	0.49	0.32	1.15	0.04



Heat-shrinkable locking fork terminals



Diagram	Cat. no.	Pkg. qty.	Wire range (AWG)	Max. ins. (in.)	Bolt hole (in.)	Rec. tool	Dimensions (in.)				Stock thick. (in.)
							A	B	C	M	
	RAS18-6FLX	100	22-18	0.170	#6	ERG4255	1.35	0.25	—	—	0.03
	RAS18-8FLX	100	22-18	0.170	#8	ERG4255	1.35	0.29	—	—	0.03
	RAS18-10FLX	100	22-18	0.170	#10	ERG4255	1.35	0.29	—	—	0.03
	RBS14-6FLX	100	16-14	0.200	#6	ERG4255	1.35	0.25	—	—	0.03
	RBS14-8FLX	100	16-14	0.200	#8	ERG4255	1.35	0.29	—	—	0.03
	RBS14-10FLX	100	16-14	0.200	#10	ERG4255	1.35	0.29	—	—	0.03
	RCS10-6FLX	50	12-10	0.250	#6	ERG4255	1.35	0.31	—	—	0.04
	RCS10-8FLX	50	12-10	0.250	#8	ERG4255	1.35	0.37	—	—	0.04
	RCS10-10FLX	50	12-10	0.250	#10	ERG4255	1.35	0.37	—	—	0.04
	RCS10-14FLX	50	12-10	0.250	¼	ERG4255	1.35	0.49	—	—	0.04

Heat-shrinkable terminals, splices and disconnects



Heat-shrinkable fully insulated female disconnects



Diagram	Cat. no.	Pkg. qty.	Wire range (AWG)	Max. ins. (in.)	Tab size (in.)	Rec. tool	A (in.)
	RAS18-250AX	25	22-18	0.170	0.250 x 0.032	ERG4255	1.82
	RBS14-250AX	25	16-14	0.200	0.250 x 0.032	ERG4255	1.77
	RCS10-250AX	25	12-10	0.250	0.250 x 0.032	ERG4255	1.80



Heat-shrinkable fully insulated male tabs



Diagram	Cat. no.	Pkg. qty.	Wire range (AWG)	Max. ins. (in.)	Tab size (in.)	Rec. tool	A (in.)
	18RAS-251TX	25	22-18	0.170	0.250 x 0.032	ERG4255	1.80
	14RBS-251TX	25	16-14	0.200	0.250 x 0.032	ERG4255	1.75
	10RCS-251TX	25	12-10	0.250	0.250 x 0.032	ERG4255	1.80



Heat-shrinkable butt splices



Diagram	Cat. no.	Pkg. qty.	Wire range (AWG)	Max. ins. (in.)	Rec. tool	Dimensions (in.)	
						A	B
	2RAS18X	50	22-18	0.170	ERG4255	1.50	0.25
	RAAS22X	500	22-18	0.170	ERG4255	1.50	0.25
	2RBS14X	50	16-14	0.200	ERG4255	1.50	0.26
	RBBS22X	500	16-14	0.200	ERG4255	1.50	0.26
	2RCS10X	25	12-10	0.250	ERG4255	1.60	0.31
	RCCS22X	250	12-10	0.250	ERG4255	1.60	0.31



Everything you need to make fully sealed connections in one handy kit

- Tools: (1) butane torch; (1) wire stripper; (1) ratchet crimp tool
- Butt splices: (20) #22-#18 AWG; (20) #16-#14 AWG; (15) #12-#10 AWG
- Ring terminals: (20) #16-#14 AWG #10 stud; (2) #16-#14 AWG #8 stud; (15) #12-#10 AWG ¼ in. stud

Heat-shrink terminal kit with tools

Cat. no.	Description	Std. pkg. qty.
STAPOUCH-HS	Heat-shrink terminal kit with tools	1

Disconnects and male tabs

250 Series — Female disconnects



- Internal barrel serrations and long barrel provide for maximum tensile strength
- Complete line of installing tools, engineered to match tool with terminal
- Funnel-entry insulators enable easier inserting of wire into barrel
- Colour-coded for easy installation

250 Series — female disconnects

- Female disconnect terminals and matching male tabs accommodate a range of #22–#10 AWG, and are available in non-insulated, partially insulated and fully insulated styles, in both nylon and vinyl
- Unique construction of the female disconnect
- offers long-term dependability
- Brazed-seam serrated barrel provides maximum tensile strength

187 Series — female disconnects

- Quick, reliable method of connection to terminal blocks and boards without the use of tools
- Female disconnect terminals and matching male tabs accommodate a range of #22–#10 AWG, and are available in non-insulated, partially insulated and fully insulated styles, in both nylon and vinyl
- Unique construction of the female disconnect offers long-term dependability



Cat. no.	Pkg. qty.	Wire range (AWG)	Max. ins. (in.)	Tab size (in.)	Fig.	Rec. tool	Dimensions (in.)	
							A	B
Nylon self-insulated								
RA18-250F	100	22–18	0.136	0.250 x 0.032	1	ERG4001	0.91	0.29
RA250-TB	1,000	22–18	0.136	0.250 x 0.032	1	ERG4001	0.91	0.29
RB14-250F	100	16–14	0.162	0.250 x 0.032	1	ERG4001	0.91	0.29
RB250	1,000	16–14	0.162	0.250 x 0.032	1	ERG4001	0.91	0.29
RC10-250F	50	12–10	0.215	0.250 x 0.032	1	ERG4001	1.04	0.29
RC250	500	12–10	0.215	0.250 x 0.032	1	ERG4001	1.04	0.29
Vinyl self-insulated								
18RA-250F	100	22–18	0.150	0.250 x 0.032	1	ERG4001	0.96	0.29
RA257	1,000	22–18	0.150	0.250 x 0.032	1	ERG4001	0.96	0.29
RA257-170	1,000	22–18	0.170	0.250 x 0.032	1	ERG4001	0.96	0.29
14RB-250F	100	16–14	0.170	0.250 x 0.032	1	ERG4001	0.96	0.29
RB257	1,000	16–14	0.170	0.250 x 0.032	1	ERG4001	0.96	0.29
RB257-200	1,000	16–14	0.200	0.250 x 0.032	1	ERG4001	0.96	0.29
10RC-250F	50	12–10	0.250	0.250 x 0.032	1	ERG4001	1.03	0.29
RC257	500	12–10	0.250	0.250 x 0.032	1	ERG4001	1.03	0.29
Nylon fully insulated								
18RA-2577	50	22–18	0.165	0.250 x 0.032	2	ERG4001	1.01	0.38
RA2573	1,000	22–18	0.165	0.250 x 0.032	2	ERG4001	1.01	0.38
14RB-2577	50	16–14	0.185	0.250 x 0.032	2	ERG4001	1.01	0.38
RB2573	1,000	16–14	0.185	0.250 x 0.032	2	ERG4001	1.01	0.38
10RC-2577	50	12–10	0.225	0.250 x 0.032	2	ERG4001	1.04	0.38
RC2573	500	12–10	0.225	0.250 x 0.032	2	ERG4001	1.04	0.38

Diagrams

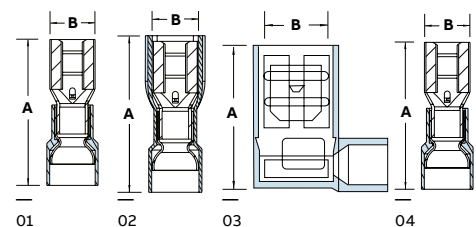

Disconnects and male tabs

250 Series — Female disconnects (cont.)



Cat. no.	Pkg. qty.	Wire range (AWG)	Max. ins. (in.)	Tab size (in.)	Fig.	Rec. tool	Dimensions (in.)	
							A	B
Nylon open top insulated 90° flag								
RA18-250A	50	22-18	0.170	0.250 x 0.032	3	ERG4001	0.80	0.71
RA2577F	500	22-18	0.170	0.250 x 0.032	3	ERG4001	0.80	0.71
RB14-250A	50	16-14	0.190	0.250 x 0.032	3	ERG4001	0.80	0.72
RB2577F	500	16-14	0.190	0.250 x 0.032	3	ERG4001	0.80	0.72
RC10-250A	50	12-10	0.245	0.250 x 0.032	3	ERG4001	0.80	0.88
RC2577F	500	12-10	0.245	0.250 x 0.032	3	ERG4001	0.80	0.88
Non-insulated								
A18-250	100	22-18	-	0.250 x 0.032	1	ERG4002	0.73	0.31
A250-TB	1,000	22-18	-	0.250 x 0.032	1	ERG4002	0.73	0.31
B14-250	100	16-14	-	0.250 x 0.032	1	ERG4002	0.73	0.31
B250	1,000	16-14	-	0.250 x 0.032	1	ERG4002	0.73	0.31
C10-250F	50	12-10	-	0.250 x 0.032	1	ERG4002	0.73	0.31
C250	500	12-10	-	0.250 x 0.032	1	ERG4002	0.73	0.31
Non-insulated/insulation grip								
B14-250F	100	16-14	-	0.250 x 0.032	4	WT110M	0.87	0.31
B250G	1,000	16-14	-	0.250 x 0.032	4	WT110M	0.87	0.31
Non-insulated 90° flag								
A18-250A	50	22-18	-	0.250 x 0.032	3	ERG4002	0.58	0.61
A252G	500	22-18	-	0.250 x 0.032	3	ERG4002	0.58	0.61
B14-250A	50	16-14	-	0.250 x 0.032	3	ERG4002. ERG4005	0.58	0.62
B252G	500	16-14	-	0.250 x 0.032	3	ERG4002. ERG4005	0.58	0.62
C10-250A	50	12-10	-	0.250 x 0.032	3	ERG4002. ERG4005	0.64	0.63
C252G	500	12-10	-	0.250 x 0.032	3	ERG4002. ERG4005	0.64	0.63

Diagrams

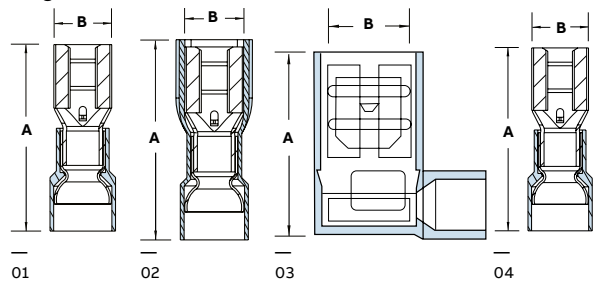

Disconnects and male tabs

250 Series — Nylon piggy-back disconnects



Cat. no.	Pkg. qty.	Wire range (AWG)	Max. ins. (in.)	Tab size (in.)	Rec. tool	Dimensions (in.)		
						A	B	C
RA18-250FP	100	22-18	0.136	0.250 x 0.032	WT112M. ERG4001	0.87	0.30	0.43
RA250P	1,000	22-18	0.136	0.250 x 0.032	WT112M. ERG4001	0.87	0.30	0.43
RB14-250FP	100	16-14	0.163	0.250 x 0.032	WT112M. ERG4001	0.87	0.30	0.43
RB250P	1,000	16-14	0.163	0.250 x 0.032	WT112M. ERG4001	0.87	0.30	0.43



Diagram

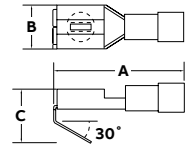

187 Series — Female disconnects



Cat. no.	Pkg. qty.	Wire range (AWG)	Max. ins. (in.)	Tab size (in.)	Fig.	Rec. tool	Dimensions (in.)	
							A	B
Nylon self-insulated								
RAD18-183	100	22-18	0.136	0.187 x 0.032	1	ERG4001	0.83	0.23
RAD1833	1,000	22-18	0.136	0.187 x 0.032	1	ERG4001	0.83	0.23
RAD18-182	100	22-18	0.136	0.187 x 0.020	1	ERG4001	0.83	0.23
RAD1823	1,000	22-18	0.136	0.187 x 0.020	1	ERG4001	0.83	0.23
RBD14-183	100	16-14	0.163	0.187 x 0.032	1	ERG4001	0.83	0.23
RBD1833	1,000	16-14	0.163	0.187 x 0.032	1	ERG4001	0.83	0.23
RBD14-182	100	16-14	0.163	0.187 x 0.020	1	ERG4001	0.83	0.23
RBD1823	1,000	16-14	0.163	0.187 x 0.020	1	ERG4001	0.83	0.23
Vinyl self-insulated								
18RAD-183	100	22-18	0.150	0.187 x 0.032	1	ERG4001	0.85	0.23
RAD1837	1,000	22-18	0.150	0.187 x 0.032	1	ERG4001	0.85	0.23
18RAD-182	100	22-18	0.150	0.187 x 0.020	1	ERG4001	0.85	0.23
RAD1827	1,000	22-18	0.150	0.187 x 0.020	1	ERG4001	0.85	0.23
14RBD-183	100	16-14	0.170	0.187 x 0.032	1	ERG4001	0.85	0.23
RBD1837	1,000	16-14	0.170	0.187 x 0.032	1	ERG4001	0.85	0.23
14RBD-182	100	16-14	0.170	0.187 x 0.020	1	ERG4001	0.85	0.23
RBD1827	1,000	16-14	0.170	0.187 x 0.020	1	ERG4001	0.85	0.23



Diagrams

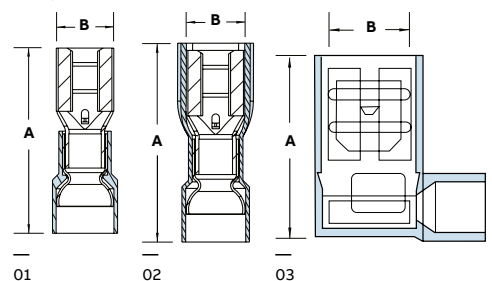

Disconnects and male tabs

187 Series — Female disconnects (cont.)



Cat. no.	Pkg. qty.	Wire range (AWG)	Max. ins. (in.)	Tab size (in.)	Fig.	Rec. tool	Dimensions (in.)	
							A	B
Nylon fully insulated								
18RAD-18377	100	22-18	0.150	0.187 x 0.032	2	ERG4001	0.89	0.30
RAD18377	1,000	22-18	0.150	0.187 x 0.032	2	ERG4001	0.89	0.30
18RAD-18277	100	22-18	0.150	0.187 x 0.020	2	ERG4001	0.89	0.30
RAD18277	1,000	22-18	0.150	0.187 x 0.020	2	ERG4001	0.89	0.30
14RBD-18377	100	16-14	0.170	0.187 x 0.032	2	ERG4001	0.89	0.30
RBD18377	1,000	16-14	0.170	0.187 x 0.032	2	ERG4001	0.89	0.30
14RBD-18277	100	16-14	0.170	0.187 x 0.020	2	ERG4001	0.89	0.30
RBD18277	1,000	16-14	0.170	0.187 x 0.020	2	ERG4001	0.89	0.30
Non-insulated								
AD18-183	100	22-18	-	0.187 x 0.032	1	ERG4002	0.64	0.23
AD183	1,000	22-18	-	0.187 x 0.032	1	ERG4002	0.64	0.23
AD18-182	100	22-18	-	0.187 x 0.020	1	ERG4002	0.64	0.23
AD182	1,000	22-18	-	0.187 x 0.020	1	ERG4002	0.64	0.23
BD14-183	100	16-14	-	0.187 x 0.032	1	ERG4002	0.64	0.23
BD183	1,000	16-14	-	0.187 x 0.032	1	ERG4002	0.64	0.23
BD14-182	100	16-14	-	0.187 x 0.020	1	ERG4002	0.64	0.23
Nylon open tap insulated 90° flag								
RAD18-187A	50	22-18	0.150	0.187 x 0.032	3	ERG4001	0.74	0.59
RAD1877F	500	22-18	0.150	0.187 x 0.032	3	ERG4001	0.74	0.59
RAD18-188A	50	22-18	0.150	0.187 x 0.020	3	ERG4001	0.74	0.59
RAD1887F	500	22-18	0.150	0.187 x 0.020	3	ERG4001	0.74	0.59
RBD14-187A	50	16-14	0.170	0.187 x 0.032	3	ERG4001	0.74	0.61
RBD1877F	500	16-14	0.170	0.187 x 0.032	3	ERG4001	0.74	0.61
RBD14-188A	50	16-14	0.170	0.187 x 0.020	3	ERG4001	0.74	0.61
RBD1887F	500	16-14	0.170	0.187 x 0.020	3	ERG4001	0.74	0.61

Diagrams

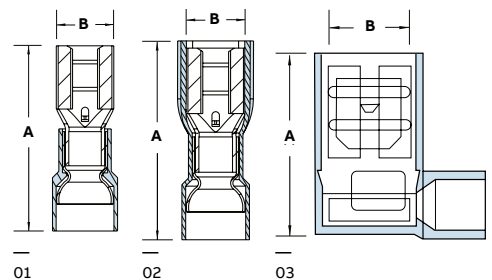

Disconnects and male tabs

250 Series — Male tabs



	Cat. no.	Pkg. qty.	Wire range (AWG)	Max. ins. (in.)	Tab size (in.)	Rec. tool	Dimensions (in.)	
							A	B
Vinyl self-insulated								
	18RA-250T	100	22-18	0.150	0.250 x 0.032	ERG4001	0.95	—
	RA2517	1,000	22-18	0.150	0.250 x 0.032	ERG4001	0.95	—
	14RB-250T	100	16-14	0.170	0.250 x 0.032	ERG4001	0.95	—
	RB2517	1,000	16-14	0.170	0.250 x 0.032	ERG4001	0.95	—
	10RC-250T	50	12-10	0.250	0.250 x 0.032	ERG4001	1.08	—
	RC2517	500	12-10	0.250	0.250 x 0.032	ERG4001	1.08	—
Nylon fully insulated								
	18RA-251T	50	22-18	0.150	0.250 x 0.032	ERG4001	1.13	0.45
	RA25177	500	22-18	0.150	0.250 x 0.032	ERG4001	1.13	0.45
	14RB-251T	50	16-14	0.170	0.250 x 0.032	ERG4001	1.13	0.45
	RB25177	500	16-14	0.170	0.250 x 0.032	ERG4001	1.13	0.45
	10RC-251T	25	12-10	0.210	0.250 x 0.032	ERG4001	1.17	0.45
	RC25177	500	12-10	0.210	0.250 x 0.032	ERG4001	1.17	0.45
Non-insulated/insulated grip								
	A18-250T	100	22-18	—	0.250 x 0.032	WT110M	0.87	—
	B14-250T	100	20-14	—	0.250 x 0.032	WT110M	0.87	—
Non-insulated								
	A18-251T	100	22-18	—	0.250 x 0.032	ERG4002	0.68	—
	A251	1,000	22-18	—	0.250 x 0.032	ERG4002	0.68	—
	B14-251T	100	16-14	—	0.250 x 0.032	ERG4002	0.68	—
	B251	1,000	16-14	—	0.250 x 0.032	ERG4002	0.68	—
	C10-251T	50	12-10	—	0.250 x 0.032	ERG4002	0.68	—

187 Series — Male tabs



	Cat. no.	Pkg. qty.	Wire range (AWG)	Max. ins. (in.)	Tab size (in.)	Rec. tool	Dimensions (in.)	
							A	B
Vinyl insulated								
	18RAD-187	100	22-18	0.150	0.187 x 0.032	ERG4001	0.87	—
	18RAD-188	100	22-18	0.150	0.187 x 0.020	ERG4001	0.87	—
	14RBD-187	100	16-14	0.170	0.187 x 0.032	ERG4001	0.87	—
	14RBD-188	100	16-14	0.170	0.187 x 0.020	ERG4001	0.87	—

Diagram

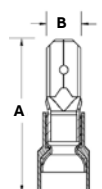



Disconnects and male tabs

Insulated coupler requires no tool.

250 Series — Adapters and coupler*



	Cat. no.	Pkg. qty.	Tab size (in.)	Dimensions (in.)	
				A	B
Non-insulated					
	F250TA	50	0.250 x 0.032	0.82	0.56
	FTA250	1,000	0.250 x 0.032	0.82	0.56
Insulated coupler					
	RB14-250	50	0.250 x 0.032	2.35	0.51
	RBB250	500	0.250 x 0.032	2.35	0.51

* Not UL Listed or CSA certified



Cat. no. F250TA — Material: brass Finish: tin-plated

Cat. no. RB14-250 — Material: brass Finish: none Insulation: vinyl

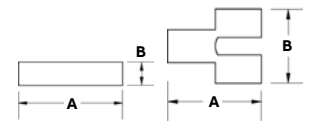
Diagrams



110 Series — Disconnects

	Cat. no.	Pkg. qty.	Wire range (AWG)	Max. ins. (in.)	Tab size (in.)	Rec. tool	Dimensions (in.)	
							A	B
Nylon-insulated								
	RA18-110F	100	22-18	0.110 x 0.032	0.110	ERG4006	0.75	0.15
	RA10-SK	1,000	22-18	0.110 x 0.032	0.110	ERG4006	0.75	0.15
	RA18-111F	100	22-18	0.110 x 0.020	0.110	ERG4006	0.75	0.15
	RA11	1,000	22-18	0.110 x 0.020	0.110	ERG4006	0.75	0.15
	RB14-110F	100	16-14	0.110 x 0.032	0.135	ERG4006	0.75	0.15
	RB10-SK	1,000	16-14	0.110 x 0.032	0.135	ERG4006	0.75	0.15
	RB14-111F	100	16-14	0.110 x 0.020	0.135	ERG4006	0.75	0.15
	RB11-TB	1,000	16-14	0.110 x 0.020	0.135	ERG4006	0.75	0.15
Non-insulated								
	A18-110F	100	22-18	0.110 x 0.032	-	WT111M. WT112M . WT2000	0.59	0.15
	A10-TB	1,000	22-18	0.110 x 0.032	-	WT111M. WT112M . WT2000	0.59	0.15
	A18-111F	100	22-18	0.110 x 0.020	-	WT111M. WT112M . WT2000	0.59	0.15
	A11	1,000	22-18	0.110 x 0.020	-	WT111M. WT112M . WT2000	0.59	0.15
	B14-110F	100	16-14	0.110 x 0.032	-	WT111M. WT112M . WT2000	0.59	0.15
	B10-TB	1,000	16-14	0.110 x 0.032	-	WT111M. WT112M . WT2000	0.59	0.15
	B14-111F	100	16-14	0.110 x 0.020	-	WT111M. WT112M . WT2000	0.59	0.15
	B11-TB	1,000	16-14	0.110 x 0.020	-	WT111M. WT112M . WT2000	0.59	0.15

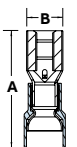

* Not UL Listed or CSA certified

Diagram



Disconnects and male tabs

Wristlock disconnects†

	Cat. no.	Pkg. qty.	Wire range (AWG)	Max. ins. (in.)	Rec. tool	Dimensions (in.)	
						A	B
Nylon-insulated							
	RA18D	50	22-18	0.136	WT2000	0.99	1.70
	RA23	1,000	22-18	0.136	WT2000	0.99	1.70
	RB14D	50	16-14	0.162	WT2000	0.99	1.70
	RB23	1,000	16-14	0.162	WT2000	0.99	1.70
Non-insulated							
	B14-D	50	16-14	0.187	WT110M	0.97	1.66
	B23	1,000	16-14	0.187	WT110M	0.97	1.66

—
Picture shows wristlock disconnect assembled as two pieces. Parts are sold by the piece not by assemblies.

† Not UL Listed

Luminaire disconnects

Disconnect ballasts under load for safe servicing – in compliance with NEC® requirements.



This cutaway shows how the Sta-Kon luminaire disconnect grips and holds the pushed-in wires securely after installation

Push-in luminaire disconnect

Each year, electricians sustain injuries while attempting to change ballasts without tripping the breaker because they're trying to avoid disconnecting other lighting and equipment from power. That's why recent changes to NEC and UL standards require a means of disconnecting power to non-residential fluorescent lighting ballasts.

In 2006, ABB developed the first UL Listed product to meet this need. In response to customer demand, the Sta-Kon push-in luminaire disconnect provides all the same safety benefits as the original, but installs even faster and easier.

- Enables electricians changing ballasts to easily disconnect incoming power for safe servicing without having to trip the main power breaker
- Installs easily – just strip de-energized wires and insert
- Disconnect halves snap together and separate easily – but won't accidentally disconnect
- Foolproof design eliminates the potential for incorrect installation and reverse polarity
- Fits through ½ in. knockouts for easy retrofit

- Ballast hot-lead wire entry is colour-coded black for easy visibility
- Finger-safe on both sides
- For use in all non-residential fluorescent lighting applications and in ordinary location HID lighting applications – both up to 600V, 4A maximum
- Complies with NEC, CEC, UL and CSA requirements
- Sold in mated pairs (male/line and female/load sides)

Specifications

- Housing: Polycarbonate
- Temperature rating: 105 °C (221 °F) max.
- Electrical rating: 600 V, 4 A max.
- Flammability rating: UL94V-2
- Contacts: Copper alloy
- Wire range: #18–#12 AWG solid copper #14–#12 AWG stranded copper (19 strands or fewer)
- Standards: Complies with 2008 NEC 410.130(G) and CEC 30-308(4)
- Certifications: UL Listed, CSA Certified



Sta-Kon push-in luminaire disconnect



Cat. no.	Description	Std. pkg. qty.
LD2P-Q	2-Wire push-in luminaire disconnect, distributor pack	25
LD2P-D	2-Wire push-in luminaire disconnect, bulk packaging	500

Note: If you prefer lead wires instead of a push-in design and/or need a 3-wire disconnect for switching or dimming applications, order the original Sta-Kon luminaire disconnect, 2-wire cat. no. LD2 (cat. no. LD2-D for bulk packaging) or 3-wire cat. no. LD3 (cat. no. LD3-D for bulk packaging). See following page.

Luminaire disconnects and disconnect installation tool



Luminaire disconnects

Cat. no.	Description
LD2C-D	2-pole luminaire disconnect (Marrettes not included)
LD3C-D	3-pole luminaire disconnect (Marrettes not included)
LD2-C	2-pole luminaire disconnect (2 x 4 Marrettes 333 /inner bag)
LD3-C	3-pole luminaire disconnect (6 of each Marrettes (331 + 333) /inner bag)



Packaging options

Cat. no.	Pkg. Format	Std. pkg. (min./mult.)
Bulk		
LD2C-D	Box	Sold without Marrettes Sold in multiple of 500
LD3C-D	Box	Inner: 50 per inner bag Outer: 250 per outer box Master: 500 in master box
Kits		
LD2-C	Bag	Sold with Marrettes Inner: 2 per inner bag
LD3-C	Bag	Sold in multiple of 20 Outer: 20 per outer box Master: 200 in master box



This one-of-a-kind tool may be used to seat all sizes of Sta-Kon disconnects.

Faster, easier and safer than manual seating of disconnects.

- Perfect for wire-harness assemblers and panel builders
- Dual-ended with slots to fit red and blue (male and female) or yellow disconnects
- Colour-coded dots for easy matching of disconnect with correct tool end
- Lightweight and only 5½ in. long — fits in a shirt pocket like a pen

Disconnect installation tool

Cat. No.	Description	Pkg. qty.
DT22-10	Sta-Kon disconnect installation tool	1

Ferrules



Features

- Ferrules ensure reliable electrical connections when terminating conductors in screw clamp terminal blocks
- Fraying and breaking of wire strands is prevented and the possibility of an unreliable connection is minimized
- Insulated ferrules prevent conductor breakage due to bending, wire stress or vibration, while facilitating wire insertions into the terminal block clamp
- Ferrules are the preferred alternative to twisting wire stands or tinning the wire end before terminating into a terminal block
- Ferrules are thin-walled copper tubes, which are mechanically crimped onto the ends of stranded wires
- They are easy to use — simply strip the wire, slide the ferrule onto the end of the wire and crimp
- Meets emerging global standards, requiring wire-to-metric style terminal block installations to be terminated with a “pin” style terminal

- Vinyl-insulated, nylon-insulated and non-insulated styles
- All styles offered in #22 AWG to #10 AWG and compatible with existing Sta-Kon tooling

How to apply a ferrule

- Strip the insulation from the end of the wire and insert into the insulated end of the ferrule
- Using the designated crimping tool, place the metal shaft into the tool's appropriate slot. Compress the tool to make a crescent-shape depression along the length of the ferrule
- Insert the crimped ferrule into the terminal block
- Tighten the ferrule and wire into the terminal block

Materials

- High-conductivity copper
- Tin plating

Insulated ferrules

Cat. no.	Conductor section		Colour	Dimensions in./mm					Installation tooling	Pkg. qty.
	AWG	mm ²		A	B	øC	øD	E		
F4004	26	0.14	Grey	0.413 / 10.5	0.236 / 6.0	0.031 / 0.80	0.079 / 2.0	0.010 / 0.25	T3, ERG4	500
F4005	26	0.14	Grey	0.492 / 12.5	0.315 / 8.0	0.031 / 0.80	0.079 / 2.0	0.010 / 0.25	T3, ERG4	500
F4006	24	0.25	Yellow	0.413 / 10.5	0.236 / 6.0	0.031 / 0.80	0.079 / 2.0	0.010 / 0.25	T3, ERG4	500
F4007	24	0.25	Yellow	0.492 / 12.5	0.315 / 8.0	0.031 / 0.80	0.079 / 2.0	0.010 / 0.25	T3, ERG4	500
F4008	22	0.34	Purple	0.413 / 10.5	0.236 / 6.0	0.031 / 0.80	0.079 / 2.0	0.010 / 0.25	T3, ERG4	500
F4009	22	0.34	Purple	0.492 / 12.5	0.315 / 8.0	0.031 / 0.80	0.079 / 2.0	0.010 / 0.25	T3, ERG4	500
F2020	20	0.50	White	0.453 / 11.5	0.236 / 6.0	0.043 / 1.1	0.098 / 2.5	0.006 / 0.15	T1, T3 & ERG4	500
F2021	20	0.50	White	0.531 / 13.5	0.315 / 8.0	0.043 / 1.1	0.098 / 2.5	0.006 / 0.15	T1, T3 & ERG4	500
F2022	20	0.50	White	0.610 / 15.5	0.394 / 10.0	0.043 / 1.1	0.098 / 2.5	0.006 / 0.15	T1, T3 & ERG4	500
F2023	18	0.75	Grey	0.472 / 12.0	0.236 / 6.0	0.051 / 1.3	0.110 / 2.8	0.006 / 0.15	T1, T3 & ERG4	500
F2024	18	0.75	Grey	0.551 / 14.0	0.315 / 8.0	0.051 / 1.3	0.110 / 2.8	0.006 / 0.15	T1, T3 & ERG4	500
F2025	18	0.75	Grey	0.630 / 16.0	0.394 / 10.0	0.051 / 1.3	0.110 / 2.8	0.006 / 0.15	T1, T3 & ERG4	500
F2026	18	0.75	Grey	0.709 / 18.0	0.472 / 12.0	0.051 / 1.3	0.110 / 2.8	0.006 / 0.15	T1, T3 & ERG4	500
F2027	18	1.00	Red	0.492 / 12.5	0.236 / 6.0	0.059 / 1.5	0.118 / 3.0	0.006 / 0.15	T1, T3 & ERG4	500
F2028	18	1.00	Red	0.571 / 14.5	0.315 / 8.0	0.059 / 1.5	0.118 / 3.0	0.006 / 0.15	T1, T3 & ERG4	500
F2029	18	1.00	Red	0.650 / 16.5	0.394 / 10.0	0.059 / 1.5	0.118 / 3.0	0.006 / 0.15	T1, T3 & ERG4	500
F2030	18	1.00	Red	0.728 / 18.5	0.472 / 12.0	0.059 / 1.5	0.118 / 3.0	0.006 / 0.15	T1, T3 & ERG4	500

Ferrule dimensions conform to DIN 46228, Part 4

Diagram

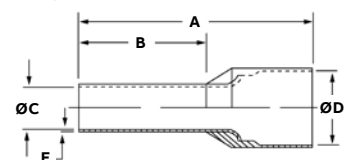

Ferrules

Insulated ferrules

Cat. no.	Conductor section		Colour	Dimensions in./mm					Installation tooling	Pkg. qty.
	AWG	mm ²		A	B	øC	øD	E		
F2031	16	1.50	Black	0.571 / 14.5	0.315 / 8.0	0.071 / 1.8	0.134 / 3.4	0.006 / 0.15	T1, T3 & ERG4	500
F2032	16	1.50	Black	0.650 / 16.5	0.394 / 10.0	0.071 / 1.8	0.134 / 3.4	0.006 / 0.15	T1, T3 & ERG4	500
F2033	16	1.50	Black	0.728 / 18.5	0.472 / 12.0	0.071 / 1.8	0.134 / 3.4	0.006 / 0.15	T1, T3 & ERG4	500
F2034	16	1.50	Black	0.965 / 24.5	0.708 / 18.0	0.071 / 1.8	0.134 / 3.4	0.006 / 0.15	T1, T3 & ERG4	500
F2035	14	2.50	Blue	0.591 / 15.0	0.315 / 8.0	0.091 / 2.3	0.165 / 4.2	0.006 / 0.15	T1, T3 & ERG4	500
F2036	14	2.50	Blue	0.748 / 19.0	0.472 / 12.0	0.091 / 2.3	0.165 / 4.2	0.006 / 0.15	T1, T3 & ERG4	500
F2037	14	2.50	Blue	0.984 / 25.0	0.708 / 18.0	0.091 / 2.3	0.165 / 4.2	0.006 / 0.15	T1, T3 & ERG4	500
F2038	12	4.00	Grey	0.889 / 17.5	0.394 / 10.0	0.114 / 2.9	0.189 / 4.8	0.008 / 0.20	ERG4	500
F2039	12	4.00	Grey	0.787 / 20.0	0.472 / 12.0	0.114 / 2.9	0.189 / 4.8	0.008 / 0.20	ERG4	500
F2040	12	4.00	Grey	1.024 / 26.0	0.708 / 18.0	0.114 / 2.9	0.189 / 4.8	0.008 / 0.20	ERG4	100
F2041	10	6.00	Yellow	0.787 / 20.0	0.472 / 12.0	0.142 / 3.6	0.244 / 6.2	0.008 / 0.20	ERG4	100
F2042	10	6.00	Yellow	0.984 / 25.0	0.708 / 18.0	0.142 / 3.6	0.244 / 6.2	0.008 / 0.20	ERG4	100
F2043	8	10.00	Red	0.827 / 21.0	0.472 / 12.0	0.181 / 4.6	0.295 / 7.5	0.008 / 0.20	ERG4	100
F2044	8	10.00	Red	1.063 / 27.0	0.708 / 18.0	0.181 / 4.6	0.295 / 7.5	0.008 / 0.20	ERG4	100
F2045	6	16.00	Blue	0.906 / 23.0	0.472 / 12.0	0.236 / 6.0	0.346 / 8.8	0.008 / 0.20	ERG4	100
F2046	6	16.00	Blue	1.142 / 29.0	0.708 / 18.0	0.236 / 6.0	0.346 / 8.8	0.008 / 0.20	ERG4	100
F2047	4	25.00	Yellow	1.142 / 29.0	0.630 / 18.0	0.295 / 7.5	0.433 / 11.0	0.008 / 0.20	ERG4	50
F2048	4	25.00	Yellow	1.220 / 31.0	0.708 / 18.0	0.295 / 7.5	0.433 / 11.0	0.008 / 0.20	ERG4	50
F2049	4	25.00	Yellow	1.378 / 35.0	0.866 / 22.0	0.295 / 7.5	0.433 / 11.0	0.008 / 0.20	ERG4	50
F2050	2	35.00	Red	1.181 / 30.0	0.630 / 16.0	0.335 / 8.5	0.492 / 12.5	0.008 / 0.20	ERG4	50
F2051	2	35.00	Red	1.260 / 32.0	0.708 / 18.0	0.335 / 8.5	0.492 / 12.5	0.008 / 0.20	ERG4	50
F2052	2	35.00	Red	1.535 / 39.0	0.984 / 25.0	0.335 / 8.5	0.492 / 12.5	0.008 / 0.20	ERG4	50
F2053	1	50.00	Blue	1.417 / 36.0	0.787 / 20.0	0.413 / 10.5	0.591 / 15.0	0.014 / 0.35	ERG4	50
F2054	1	50.00	Blue	1.614 / 41.0	0.984 / 25.0	0.413 / 10.5	0.591 / 15.0	0.014 / 0.35	ERG4	50

Ferrule dimensions conform to DIN 46228, Part 4

Diagram

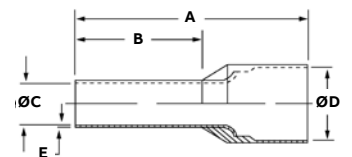

Ferrules



Strip lengths for insulated ferrules

Cat. no.	Pin length (in.)	Min. strip length (in.)	Max. strip length (in.)
F2020	0.236	0.3147	0.354
F2021	0.315	0.3937	0.433
F2022	0.394	0.4727	0.512
F2023	0.236	0.3147	0.354
F2024	0.315	0.3937	0.433
F2025	0.394	0.4727	0.512
F2026	0.472	0.5507	0.59
F2027	0.236	0.3147	0.354
F2028	0.315	0.3937	0.433
F2029	0.394	0.4727	0.512
F2030	0.472	0.5507	0.59
F2031	0.315	0.3937	0.433
F2032	0.394	0.4727	0.512
F2033	0.472	0.5507	0.59
F2034	0.708	0.7867	0.826
F2035	0.315	0.3937	0.433
F2036	0.472	0.5507	0.59
F2037	0.708	0.7867	0.826
F2038	0.394	0.4727	0.512
F2039	0.472	0.5507	0.59
F2040	0.708	0.7867	0.826
F2041	0.472	0.5507	0.59
F2042	0.708	0.7867	0.826
F2043	0.472	0.5507	0.59
F2044	0.708	0.7867	0.826
F2045	0.472	0.5507	0.59

Cat. no.	Pin length (in.)	Min. strip length (in.)	Max. strip length (in.)
F2046	0.708	0.7867	0.826
F2047	0.63	0.7087	0.748
F2048	0.708	0.7867	0.826
F2049	0.866	0.9447	0.984
F2050	0.53	0.6087	0.648
G2051	0.708	0.7867	0.826
G2052	0.984	1.0627	1.102
G2053	0.787	0.8657	0.905
F2054	0.984	1.0627	1.102
F4000	0.315	0.3937	0.433
F4001	0.315	0.3937	0.433
F4002	0.315	0.3937	0.433
F4003	0.315	0.3937	0.433
F4004	0.236	0.3147	0.354
F4005	0.315	0.3937	0.433
F4006	0.236	0.3147	0.354
F4007	0.315	0.3937	0.433
F4008	0.236	0.3147	0.354
F4009	0.315	0.3937	0.433
F4020	0.315	0.3937	0.433
F4021	0.315	0.3937	0.433
F4022	0.315	0.3937	0.433
F4023	0.315	0.3937	0.433
F4024	0.315	0.3937	0.433
F4027	0.315	0.3937	0.433
F4028	0.315	0.3937	0.433

Note: The stripping length is based on the thickness of the insulation wire – more thickness, more stripping length.

Ferrules



Insulated twin ferrules

Diagram	Conductor section				Dimensions in./mm					Installation tool	Pkg. qty.
	Cat. no.	AWG	mm ²	Colour	A	B	øC	øD	E		
	F8000	2 x 20	2 x 0.50	White	0.591 / 15.0	0.315 / 8.0	0.059 / 1.5	0.177 / 4.5	0.010 / 0.25	T3	500
	F8001	2 x 18	2 x 0.75	Grey	0.591 / 15.0	0.315 / 8.0	0.071 / 1.8	0.201 / 5.1	0.006 / 0.15	T3	500
	F8002	2 x 18	2 x 0.75	Grey	0.669 / 17.0	0.394 / 10.0	0.071 / 1.8	0.201 / 5.1	0.006 / 0.15	T3	500
	F8003	2 x 17	2 x 1.00	Red	0.591 / 15.0	0.315 / 8.0	0.081 / 2.05	0.201 / 5.1	0.006 / 0.15	T3	500
	F8005	2 x 17	2 x 1.00	Red	0.669 / 17.0	0.394 / 10.0	0.081 / 2.05	0.201 / 5.1	0.006 / 0.15	T3	500
	F8006	2 x 16	2 x 1.50	Black	0.630 / 16.0	0.315 / 8.0	0.091 / 2.3	0.252 / 6.4	0.006 / 0.15	T3	500
	F8007	2 x 16	2 x 1.50	Black	0.787 / 20.0	0.472 / 12.0	0.091 / 2.3	0.252 / 6.4	0.006 / 0.15	T3	500
	F8008	2 x 14	2 x 2.50	Blue	0.728 / 18.5	0.394 / 10.0	0.114 / 2.9	0.295 / 7.5	0.006 / 0.15	T3	500
	F8009	2 x 14	2 x 2.50	Blue	0.846 / 21.5	0.512 / 13.0	0.114 / 2.9	0.295 / 7.5	0.006 / 0.15	T3	500
	F8010	2 x 12	2 x 4.00	Grey	0.906 / 23.0	0.472 / 12.0	0.150 / 3.8	0.339 / 8.6	0.006 / 0.15	ERG4/ matrice 6 mm	100
	F8011	2 x 10	2 x 6.00	Yellow	0.984 / 25.0	0.551 / 14.0	0.193 / 4.9	0.378 / 9.6	0.008 / 0.20	ERG4/ matrice 10 mm	100

Ferrule dimensions conform to DIN 46228, Part 4



Insulated ferrules (old DIN and French standards)

Diagram	Conductor				Dimensions in./mm					Installation tool	Pkg. qty.	
	Cat. no.	Style	AWG	mm ²	Colour	A	B	øC	øD			E
	F4000	Old DIN	20	0.50	Orange	0.571 / 14.5	0.315 / 8.0	0.043 / 1.1	0.102 / 2.6	0.006 / 0.15	T1, T3 & ERG4	500
	F4001	Old DIN	18	0.75	White	0.571 / 14.5	0.315 / 8.0	0.051 / 1.3	0.110 / 2.8	0.006 / 0.15	T1, T3 & ERG4	500
	F4002	Old DIN	18-17	1.00	Yellow	0.571 / 14.5	0.315 / 8.0	0.059 / 1.5	0.118 / 3.0	0.006 / 0.15	T1, T3 & ERG4	500
	F4003	Old DIN	16	1.50	Red	0.571 / 14.5	0.315 / 8.0	0.071 / 1.8	0.134 / 3.4	0.006 / 0.15	T1, T3 & ERG4	500
	F4020	Old DIN	14	2.50	Blue	0.571 / 14.5	0.315 / 8.0	0.091 / 2.3	0.165 / 4.2	0.006 / 0.15	T1, T3 & ERG4	500
	F4021	French	20	0.50	White	0.571 / 14.5	0.315 / 8.0	0.043 / 1.1	0.102 / 2.6	0.006 / 0.15	T1, T3 & ERG4	500
	F4023	French	18	0.75	Lt. Blue	0.571 / 14.5	0.315 / 8.0	0.051 / 1.3	0.110 / 2.8	0.006 / 0.15	T1, T3 & ERG4	500
	F4024	French	18-17	1.00	Red	0.571 / 14.5	0.315 / 8.0	0.059 / 1.5	0.118 / 3.0	0.006 / 0.15	T1, T3 & ERG4	500
	F4027	French	16	1.50	Black	0.571 / 14.5	0.315 / 8.0	0.071 / 1.8	0.134 / 3.4	0.006 / 0.15	T1, T3 & ERG4	500
	F4028	French	14	2.50	Grey	0.571 / 14.5	0.315 / 8.0	0.091 / 2.3	0.165 / 4.2	0.006 / 0.15	T1, T3 & ERG4	500

Ferrule dimensions conform to DIN 46228, Part 4



T1



T3



ERG4

Tooling for Sta-Kon insulated ferrules

Cat. no.	Description	Pkg. qty.
T1	Sta-Kon crimp tool for wire ferrules #20-#14 AWG - insulated handle	1
T3	Sta-Kon crimp tool for wire ferrules #26-#10 AWG - insulated handle	1
ERG4	Comfort Crimp™ Sta-Kon crimp tool with Shure-Stake mechanism, for installing wire ferrules #26-1/0 AWG. Four interchangeable die sets included. Insulated handle. Packaged in sturdy plastic carrying case.	1

Ferrules



Non-insulated ferrules

Cat. no.	Conductor section		Dimensions in./mm				Installation tooling	Pkg. qty.
	AWG	mm ²	A	C	D	E		
F9000	24	0.25	0.196 / 5	0.030 / 0.75	0.067 / 1.7	0,006 / 0,15	T1, T3, ERG4	1,000
F9001	22	0.5	0.236 / 6	0.039 / 1.0	0.083 / 2.1	0,006 / 0,15	T1, T3, ERG4	1,000
F9002	22	0.5	0.394 / 10	0.039 / 1.0	0.083 / 2.1	0,006 / 0,15	T1, T3, ERG4	1,000
F9003	18	0.75	0.236 / 6	0.047 / 1.2	0.091 / 2.3	0,006 / 0,15	T1, T3, ERG4	1,000
F9004	18	0.75	0.394 / 10	0.047 / 1.2	0.091 / 2.3	0,006 / 0,15	T1, T3, ERG4	1,000
F9005	18	1	0.236 / 6	0.055 / 1.4	0.098 / 2.5	0,006 / 0,15	T1, T3, ERG4	1,000
F9006	18	1	0.394 / 10	0.055 / 1.4	0.098 / 2.5	0,006 / 0,15	T1, T3, ERG4	1,000
F9007	16	1.5	0.276 / 7	0.067 / 1.7	0.110 / 2.8	0,006 / 0,15	T1, T3, ERG4	1,000
F9008	16	1.5	0.394 / 10	0.067 / 1.7	0.110 / 2.8	0,006 / 0,15	T1, T3, ERG4	1,000
F9009	16	1.5	0.473 / 12	0.067 / 1.7	0.110 / 2.8	0,006 / 0,15	T1, T3, ERG4	1,000
F9010	16	1.5	0.709 / 18	0.067 / 1.7	0.110 / 2.8	0,006 / 0,15	T1, T3, ERG4	1,000
F9011	14	2.5	0.276 / 7	0.087 / 2.2	0.139 / 3.4	0,006 / 0,15	T1, T3, ERG4	1,000
F9012	14	2.5	0.394 / 10	0.087 / 2.2	0.139 / 3.4	0,006 / 0,15	T1, T3, ERG4	1,000
F9013	14	2.5	0.472 / 12	0.087 / 2.2	0.139 / 3.4	0,006 / 0,15	T1, T3, ERG4	1,000
F9014	14	2.5	0.709 / 18	0.087 / 2.2	0.139 / 3.4	0,006 / 0,15	T1, T3, ERG4	1,000
F9015	12	4	0.354 / 9	0.110 / 2.8	0.158 / 4	0,008 / 0,2	T3, ERG4	1,000
F9016	12	4	0.472 / 12	0.110 / 2.8	0.158 / 4	0,008 / 0,2	T3, ERG4	1,000
F9017	12	4	0.591 / 15	0.110 / 2.8	0.158 / 4	0,008 / 0,2	T3, ERG4	1,000
F9018	12	4	0.709 / 18	0.110 / 2.8	0.158 / 4	0,008 / 0,2	T3, ERG4	1,000
F9019	10	6	0.472 / 12	0.138 / 3.5	0.185 / 4.7	0,008 / 0,2	T3, ERG4	1,000
F9020	10	6	0.591 / 15	0.138 / 3.5	0.185 / 4.7	0,008 / 0,2	T3, ERG4	1,000
F9021	10	6	0.709 / 18	0.138 / 3.5	0.185 / 4.7	0,008 / 0,2	T3, ERG4	1,000
F9022	8	10	0.472 / 12	0.177 / 4.5	0.228 / 5.8	0,008 / 0,2	ERG4	500
F9023	8	10	0.591 / 15	0.177 / 4.5	0.228 / 5.8	0,008 / 0,2	ERG4	500
F9024	8	10	0.709 / 18	0.177 / 4.5	0.228 / 5.8	0,008 / 0,2	ERG4	500
F9025	6	16	0.472 / 12	0.228 / 5.8	0.295 / 7.5	0,008 / 0,2	ERG4	250
F9026	6	16	0.591 / 15	0.228 / 5.8	0.295 / 7.5	0,008 / 0,2	ERG4	250
F9027	6	16	0.709 / 18	0.228 / 5.8	0.295 / 7.5	0,008 / 0,2	ERG4	250
F9028	6	16	0.984 / 25	0.228 / 5.8	0.295 / 7.5	0,008 / 0,2	ERG4	250
F9029	6	16	1.26 / 32	0.228 / 5.8	0.295 / 7.5	0,008 / 0,2	ERG4	250
F9030	4	25	0.591 / 15	0.287 / 7.3	0.374 / 9.5	0,010 / 0,25	ERG4	100
F9031	4	25	0.709 / 18	0.287 / 7.3	0.374 / 9.5	0,010 / 0,25	ERG4	100
F9032	4	25	0.984 / 25	0.287 / 7.3	0.374 / 9.5	0,010 / 0,25	ERG4	100
F9033	4	25	1.26 / 32	0.287 / 7.3	0.374 / 9.5	0,010 / 0,25	ERG4	100
F9034	2	35	0.709 / 18	0.327 / 8.3	0.433 / 11	0,010 / 0,25	ERG4	100
F9035	2	35	0.984 / 25	0.327 / 8.3	0.433 / 11	0,010 / 0,25	ERG4	100
F9036	2	35	1.26 / 32	0.327 / 8.3	0.433 / 11	0,010 / 0,25	ERG4	100
F9037	1/0	50	0.709 / 18	0.406 / 10.3	0.512 / 13	0,012 / 0,3	TB5095, ERG4	100
F9038	1/0	50	0.984 / 25	0.406 / 10.3	0.512 / 13	0,012 / 0,3	TB5095, ERG4	100
F9039	1/0	50	1.18 / 30	0.406 / 10.3	0.512 / 13	0,012 / 0,3	TB5095, ERG4	100

Diagram

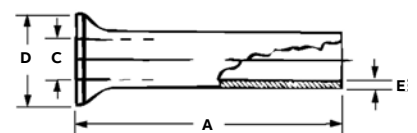

Installing kits

Sta-Kon mini-pack terminals



Convenient 20-count packaging.

- Wire ranges from #22 AWG to #10 AWG
- Vinyl-insulated ring and forked-tongued terminals, female disconnects, butt-type splice connectors

Note: "CP" designates mini-pack quantities. Refer to other catalogue pages for description and dimensional information.

Cat. No.	Unit qty.	Pkg. qty.	Wire range (AWG)	Bolt hole (in.)
18RA-6FCP	20	100	22-18	#6
18RA-8CP	20	100	22-18	#8
18RA-10CP	20	100	22-18	#10
14RB-6CP	20	100	16-14	#6
14RB-8CP	20	100	16-14	#8
14RB-10CP	20	100	16-14	#10
10RC-10CP	20	100	12-10	#10
10RC-14CP	20	100	12-10	¼
18RA-8FCP	20	100	22-18	#8
18RA-10FCP	20	100	22-18	#10
14RB-6FCP	20	100	16-14	#6
14RB-8FCP	20	100	16-14	#8
14RB-10FCP	20	100	16-14	#10
10RC-8FCP	20	100	12-10	#8
10RC-10FCP	20	100	12-10	10
2RA18XCP	20	100	22-18	-
2RB14XCP	20	100	16-14	-
2RC10XCP	20	100	12-10	-
18RA-250FCP	20	100	22-18	-
14RB-250FCP	20	100	16-14	-
10RC-250FCP	20	100	12-10	-

Installing kits

Sta-Org™ terminal and splice organizer kit



Lightweight, durable, nylon construction.

- Ideal for contractors, OEMs or any other user of terminals and splices
- Slips in a tool box or sits on your bench — only 6.6 in. L x 3 in. dia.
- Bench-mountable (hardware included)
- Kit contents
 - (1) blue nylon organizer/carrier
 - (6) see-through nylon canisters with lids
 - (20) #12–#10 AWG vinyl ring terminals (cat. no. 10RC-10)
 - (25) #18–#14 AWG vinyl ring terminals (cat. no. 14RB-10)
 - (15) #12–#10 AWG vinyl butt splices (cat. no. 2RC-10X)
 - (25) #18–#14 AWG vinyl butt splices (cat. no. 2RB-14X)
 - (20) #12–#10 AWG vinyl fork terminals (cat. no. 10RC-10F)
 - (25) #18–#14 AWG vinyl fork terminals (cat. no. 14RB-10F)

Cat. No.	Description	Pkg. Qty.
STA-ORG	Sta-Kon Sta-Org terminal and splice organizer kit	1

Installing kits

Terminal kits

For residential or light commercial installations, we recommend this proven assortment of popular Sta-Kon vinyl terminals. This kit includes a WT112M crimping tool.



Kit contains:

- 36 2RA18X butt splices for 22–16 AWG
- 36 18RA-8F fork terminals for 22–16 AWG
- 36 18RA-10F fork terminals for 22–16 AWG
- 36 18RA-8 ring terminals for 22–16 AWG
- 36 18RA-10 ring terminals for 22–16 AWG
- 36 RBB217-200 butt splices for 16–14 AWG
- 36 14RB-10F fork terminals for 18–14 AWG
- 36 18RA-250F disconnects for 22–18 AWG
- 36 14RB-8F fork terminals for 18–14 AWG
- 36 14RB-8 ring terminals for 18–14 AWG
- 36 14RB-10 ring terminals for 18–14 AWG
- 25 RCC217-250 butt splices for 12–10 AWG
- 25 10RC-8F fork terminals for 12–10 AWG
- 25 10RC-10 ring terminals for 12–10 AWG
- 20 RC6 wire joints
- 1 WT112M crimping tool
- 50 833 wire connectors yellow 22-8 AWG

Terminal kit

Cat. no.	Description	Pkg. qty.
SK-CLASSIQUE	Terminal kit	1

Perfect for residential or light commercial installations.

- Assortment of popular Sta-Kon vinyl terminals
- Kit includes a WT112M crimping tool
- Includes cable ties and wire marker book



Kit contains:

- 100 2RA18X butt splices for 22–18 AWG
- 100 2RB14X butt splices for 18–14 AWG
- 50 2RC10X butt splices for 12–10 AWG
- 50 10RC-10 ring terminals for 12–10 AWG
- 50 10RC-10FL locking fork terminals for 12–10 AWG
- 50 10RC-250F disconnects for 12–10 AWG
- 100 14RB-10 ring terminals for 18–14 AWG
- 100 14RB-8FL locking fork terminals for 18–14 AWG
- 100 14RB-250F disconnects for 18–14 AWG
- 100 18RA-8F fork terminals for 22–18 AWG
- 100 18RA-6FL locking fork terminals for 22–18 AWG
- 100 18RA-250F disconnects for 22–18 AWG
- 1 WM-0-THRU9 wire marker book
- 1 WT112M crimping tool
- 100 TY525M Ty-Rap® cable ties (approx. length 7½)

Note: All splices, terminals and disconnects are vinyl insulated.

Sta-Kit installing kit

Cat. no.	Description	Pkg. qty.
STAKIT	Assortment of Sta-Kon vinyl terminals, splices and disconnects. Includes crimp tool, cable ties and wire book marker.	1

Application tools

Recommended tools

- 01 WT112M
- 02 ERG4001
- 03 12050



The Shure-Stake mechanism on mechanical ratchet tools and power tools prevents the dies from releasing the terminal until the proper compression has been completed. With this method, an operator achieves a reliable crimp every time. ABB tooling techniques correctly match tools, wire size and terminal to produce optimum mechanical and electrical performance.

Plier-type if installations are fewer than 20 per day



— 01

Ratchet-type if installations are more than 20 per day



— 02

Power-type if installations are more than 200 per day



— 03

Plier-type tools

Cat. no.	For use with Sta-Kon series	Pkg. qty.
WT110M	A, B, C non-insulated terminals and splices and A, B non-insulated terminals with insulation grip	1
WT111M	A, B, C, PT non-insulated terminals and splices; includes cutters	1
WT112M	A, B, C non-insulated and RA, RB, RC insulated nylon and vinyl terminals and splices; includes cutters	1
WT161M	A, B, C, PT non-insulated terminals and splices; includes plier grip and cutters	1
WT2000	A, B, C, AB, PT, RA, RB, RC insulated and non-insulated terminals and splices; includes wire cutters, bolt cutters and wire stripper	1

- 04 WT110M
- 05 WT111M
- 06 WT112M
- 07 WT161M
- 08 WT2000



— 04



— 05



— 06



— 07



— 08

Application tools

The proper installation procedure for the quality-assured connection.

—
01 ERG4001
Shure-Stake tools are
matched to terminals

The proper installation of terminals, splices and connectors is very important to the efficient performance of an electrical system. The properly installed connector will enable good conductivity through the termination. Certain basic requirements must be met to make a good termination.

- Strip the insulation carefully to avoid nicking or cutting conductor strands
- Strip the insulation to the proper length so the conductors can be inserted fully into the connector barrel; the wire/cable should be visible in the inspection hole of the lug

A poor termination results in a high-resistance connection. A poor connector installation may cause damage or failure of an entire system.

Safety warning: Keep fingers and hands away from mechanism during crimp function.

Installation procedure

- Strip the insulation carefully to avoid nicking or cutting conductor strands.
- Strip the insulation to the proper length so the conductors can be inserted fully into the connector barrel; the wire/cable should be visible in the inspection hole of the lug.
- Train the wires to eliminate fanning of strands.
- Open handles fully.
- Insert terminal in proper die nest and locate it as shown below. When crimping a butt splice, position in proper die nest with window facing indenter.
- Close handles slightly to secure terminal. Do not deform terminal.
- Insert properly stripped wire into terminal.
- Complete crimp by closing handles.



—
01

Diagram

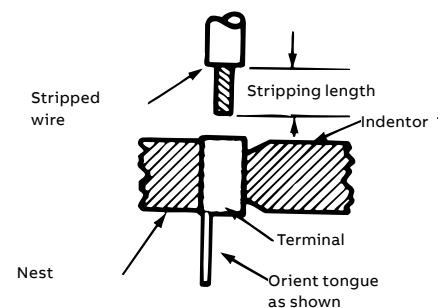

Application tools

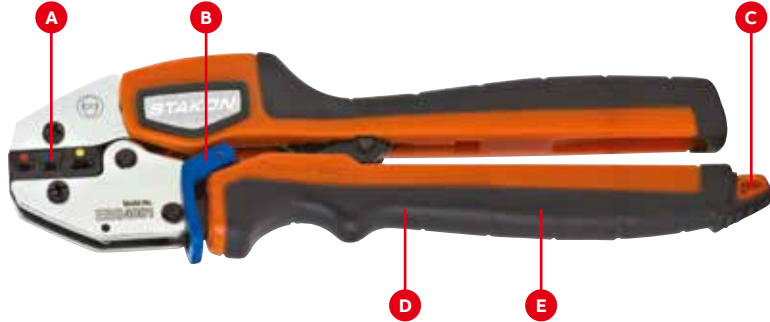

A Colour-coded die nests (left and right side) provided for proper crimping of insulated terminals

B Shure-Stake mechanism ensures a proper crimp every time

C Crimp-Assist foot provides stability when work surface leverage is needed to crimp larger connectors

D Ergonomically advanced, soft, over-molded handle grips reduce strain and enhance user comfort

E Requires one of the lowest handle forces of any tooling in its class – 25% less than the previous generation of Comfort Crimp tools

Redesigned family of termination tools sets a new standard for manual crimping tools. The most comfortable crimp available from a manual compression tool.





Sta-Kon Comfort Crimp compression tools previously set the standard for manual crimp tools. Now, ABB engineers have made a great line of tools even better with the newly redesigned Sta-Kon Comfort Crimp compression tools. We kept all the performance features that made the tools industry leaders, such as the Shure-Stake mechanism and interchangeable dies with colour-coded die nests, and focused on creating the best possible user experience in terms of comfort and reduction of strain.

Ergonomic handles position the user’s hands correctly to minimize the risk of strain, and soft, over-molded grips cushion fingers and palm for user comfort. A new Crimp-Assist™ foot stabilizes the tool when the user needs to place it on a work surface for leverage to crimp larger connectors. Best of all, the redesigned Comfort Crimp tools require 25% less handle force to complete the crimp cycle than the previous generation — and up to 75% less handle force than competing tools.

Requiring one of the lowest handle forces of any tool in its class, the Comfort Crimp tool family provides maximum comfort to installers, without sacrificing the durability or performance associated with ABB tools.

- Perfect for OEM, MRO and field use
- UL Listed for use with Sta-Kon connectors
- Shure-Stake mechanism ensures a complete crimp cycle before release for a proper crimp every time
- Colour-coded die nests for easy matching with Sta-Kon insulated terminals
- Creates integrity dots for quick verification of proper crimp
- Advanced manufacturing methods for improved durability and tool life
- Lanyard hole in handle for easy tethering to workstation
- Calibration service available through ABB Tool Services

Comfort Crimp compression tools

	Cat. no.	For use with Sta-Kon series	Pkg. qty.
	ERG4001	RA, RB, RC nylon & vinyl terminals, splices & disconnects	1
	ERG4002	A, B, C non-insulated terminals, splices, disconnects	1
	ERG4004	A, B and C flag terminals	1
	ERG4005	B, C, D, E non-insulated terminals, splices (D & E tubular only)	1
	ERG4006	RA, RB disconnects and RZ terminals	1
	ERG4007	RD & RE insulated terminals (tubular only)	1
	ERG4008	Non-insulated terminals #8–1/0 AWG (tubular only)	1
			

Note: Contact tool services for gauging

Application tools



WT1377 ratchet hand tool

Cat. no.	For use with Sta-Kon series	Pkg. qty.
WT1377	NW ring terminals	1

Correct compression every time — the Shure-Stake mechanism principle prevents opening of the handles until full staking action is completed. Installs self-insulated and non-insulated Sta-Kon terminal series in the #26–#10 AWG wire range.



WT2130A ratchet hand tool

Cat. no.	For use with Sta-Kon series	Pkg. qty.
WT2130A	RC, RBC and RD insulated terminals, RC6, RP7 wire joints	1



ERG4006 hand tool

Cat. no.	For use with Sta-Kon series	Pkg. qty.
ERG4006	RZ terminals/splices RA, RB insulated disconnects	1



WT3185 ratchet hand tool

Cat. no.	For use with Sta-Kon series	Pkg. qty.
WT3185	For #8 AWG to 250 kcmil non-insulated Sta-Kon terminals	1

Note: For gauging information, contact Tool Services



ERG4255 ratchet hand tool

Cat. no.	For use with Sta-Kon series	Pkg. qty.
ERG4255	RA, RB, RC heat-shrinkable nylon-insulated terminals, butt splices and disconnects	1



WT129 flag terminal type hand tool

Cat. no.	For use with Sta-Kon series	Pkg. qty.
WT129	D, E, F & G non-insulated flag terminals	1

Application tools

01 ERG1-WS
02 "V" Blade cassette



Integral wire cutter lets user cut and strip with the same tool.

- Interchangeable cassettes enable the user to strip a wide range of insulations without having to change tools
- Tool automatically strips wire to preset length

Sta-Kon ERG1-WS Wire stripping/cutting tool

Cat. no.	Description	Pkg. qty.
ERG1-WS	Ergonomic wire stripping tool	1
VBC-1	Replacement "V" blade cassette	1

ERG1-WS Wire stripping/cutting tool is shipped with one straight blade cassette (SBC-1).
"V" Blade cassettes sold separately.



WT115A Toggle-type hand tool

Cat. no.	For use with Sta-Kon series	Pkg. qty.
WT115A	D, E, F & G non-insulated terminals	1



03 TBM6

03

TBM6 and TBM6S Toggle-type hand tools

Cat. no.	For use with Sta-Kon series	Pkg. qty.
TBM6	D through M, RD through RM	1
TBM6S	D through M, RD through RM with Shure-Stake	1

Dies not included.
Note: These tools can also be used to crimp Blackburn® lugs and splices.

Installing dies for non-insulated code and aircraft Sta-Kon terminals

Cat. no.	Indentor stationary die	Indentor movable die	Term. Size
11803	-	-	D, E (tubular)
11805	-	-	E (brazed), F (tubular)
11806	11802	-	F (brazed), G
11807	-	-	H
11808	-	-	J
11809	-	-	K
11810	-	-	L
11811	-	-	M

Installing dies for nylon-insulated Sta-Kon terminals

Die set cat. no.	Term. size
11821	RD (tubular)
11822	RD (brazed seam) RE (tubular)
11823	RF
11824	RG
11825	RH
11826	RJ
11827	RK
11828	RL
11829	RM

Application tools

Shure-Stake auto-feed tool



Safe, fast, high-volume crimping machine.

- Shure-Stake mechanism
- Fully guarded foot pedal
- Clear plastic safety guard over die area
- Dies colour-coded to terminals
- #26–#10 AWG wire range
- Installs insulated and non-insulated terminals and disconnects

Installing dies for 12050

Cat. no.	Description	Pkg. qty.
12050	Compact, pneumatically operated unit for crimping tape-mounted Sta-Kon terminals; equipped with a Shure-Stake mechanism, which ensures a full compression each time	1

Space requirement: 30 in. W x 20 in. H x 20 in. D

Weight: 55 lb

Air pressure: 90–125 psi input air supply

Die cat. no.	Sta-Kon terminal type	Wire size (AWG)	Pkg. qty.
12051	RA — Nylon	22–18	1
12054*	RA — Vinyl	22–18	1
12061	RA — Disconnect	22–18	1
12052	RB — Nylon	16–14	1
12055*	RB — Vinyl	16–14	1
12062	RB — Disconnect	16–14	1
12056	RC — Nylon and vinyl insulated	12–10	1
12057	A — Non-insulated	22–18	1
12058	B — Non-insulated	16–14	1
12059	C — Non-insulated	12–10	1
12060	C — Disconnect, non-insulated	12–10	1

* Can also be used on nylon

Application tools

BAT22-6NV2 Battery-powered crimping tool



The Sta-Kon BAT22-6NV2 is motorized and automatic for effortless, single-lever crimping.

This is an excellent tool for various markets including panel builders, system integrators, data centers, utilities and various other OEM and MRO applications.

The lightweight, ergonomic design minimizes the risk of repetitive motion injuries that can occur with traditional hand crimping tools.

- 150,000 cycle lifespan
- Extremely light and efficient
- Crimps both Sta-Kon and Dragon Tooth terminals

- Comes complete with extra battery, charger and carrying case
- Powerful lithium-ion battery with charge-level indicator
- Single-lever motorized operation for easy manual preclamping, automatic crimping and auto-retract functions
- Motor-stall protection in case of faulty operation
- LED work light illuminates work areas

Included accessories

- Sturdy, plastic carrying case for portability
- Two 10.8 V lithium-ion batteries and charger
- Sturdy tray for convenient storage of crimp dies



Installing dies for BAT22-6NV2



Cat. no.	Description	Pkg. qty.
BAT22-6NV2	Battery-powered crimping tool with two 10.8 V lithium-ion batteries	1
Die sets*		
DIE2001	Sta-Kon insulated 22–10 AWG terminals	1
DIE2002	Sta-Kon non-insulated 22–10 AWG terminals	1
DIE2005	Sta-Kon non-insulated 16–14, 12–10, 8–6 AWG tubular terminals	1
DIE2007	Sta-Kon insulated 8–6 AWG tubular terminals	1
DIE2009	Sta-Kon wire joints RB, RC, RP series 22–10	1
DIE2500	Spec-Kon™ insulated 22–10 AWG terminals	1
DIE1806**	Dragon Tooth terminals 22F, L, R–6 series	1

*Dies sold separately.

** DIE1806 is not CSA certified or UL Listed.

Application tools

PAIR22-6 Air crimp tool



Heavy-duty portable tool.

- 1.25 tons output force at 100 psi
- Crimps #22–#6 AWG terminals
- Installs Sta-Kon terminals as well as ferrules and Dragon Tooth™ connectors
- Interchangeable dies
- Open yoke enables easy access to insert and remove terminals for crimping

Installing dies for PAIR22-6

Cat. no.	Description	Pkg. qty.
PAIR22-6	Open yoke, hand-actuated air crimp tool	1
Crimp dies*		
DIE2001	Insulated #22–#10 AWG Sta-Kon terminals	1
DIE2002	Non-Insulated #22–#10 AWG Sta-Kon terminals	1
DIE2005	Non-insulated #16–#10/#8–#6 Sta-Kon terminals (tubular only)	1
DIE2007	Insulated #8–#6 AWG Sta-Kon terminals (tubular only)	1

* Dies sold separately.

Note: The dies for the BAIR22-6, PAIR22-6 and BAT22-6 are interchangeable.

Note: Battery-powered tools BPI42300CR, BPLT6BSCR and BPLT62BSCR can also be used to crimp non-insulated Sta-Kon terminals.

Application tools

Bench-mounted air tools



BAIR22-6 Bench-mounted air tool

Crimps #22–#6 AWG terminals.

- 1.8 tons output force at 100 psi
- Bench-mounted heavy-duty air tool
- Short cycle time
- Shure-Stake mechanism
- Foot actuated
- Accepts ABB standard hand tool dies
- Installs Sta-Kon and Spec-Kon terminals, as well as ferrules and Dragon Tooth connectors

Cat. no.	Description	Pkg. qty.
BAIR22-6	Heavy-duty, high-speed production tool installs a wide range of Sta-Kon terminals, from #26–#6 AWG; uses the DIE2000 series dies for both non-insulated and insulated terminals; supplied complete with foot pedal, air hose/air lubricator	1
Crimp dies*		
DIE2001	Insulated #22–#10 AWG Sta-Kon terminals	1
DIE2002	Non-Insulated #22–#10 AWG Sta-Kon terminals	1
DIE2005	Non-Insulated #16–#10/#8–#6 Sta-Kon terminals (tubular only)	1
DIE2007	Insulated #8–#6 AWG Sta-Kon terminals (tubular only)	1

* Dies sold separately.

Note: The dies for the BAIR22-6, PAIR22-6 and BAT22-6 are interchangeable.

Note: Battery-powered tools BPI42300CR, BPLT6BSCR and BPLT62BSCR can also be used to crimp non-insulated Sta-Kon terminals.



Crimps #8 AWG–250 kcmil. Convenience and economy

The tool accepts a full range of interchangeable dies, the same as used in the TBM6 or TBM6S tools. To install the dies, simply pull the spring-loaded pin and remove the indentor die. Then, flex the retaining spring and remove the die nest.

Shure-Stake mechanism means quality connections

The Shure-Stake mechanism senses inlet air pressure, and if insufficient, is designed to prevent the tool from cycling. Thus you avoid “under-crimping.” An 85–90-psi air pressure source is required.

Safety features increase productivity, reduce downtime

Safety features include a guard over the die area, an air shutdown switch activated by a slight push with the finger and a foot pedal that’s enclosed to prevent accidental tool operation. In addition, the tool may be bench-mounted for stability and control. For convenience when crimping large size terminals on heavy wire, the head assembly may overhang the workbench.

Air-operated bench-mounted tool

Cat. no.	Description	Pkg. qty.
25000	This compact heavy-duty air tool installs nylon insulated Sta-Kon terminals on wire sizes from #8 AWG to 250 kcmil; non-insulated styles are also installed just as quickly and dependably; heavy-duty air tool installs non-insulated and insulated Sta-Kon terminals from #8 AWG to 250 kcmil	1

Note: This tool uses the same dies as the TBM6 and TBM6S hand tools on page 60.

Application Tools

Hydraulic heads



Installs insulated and non-insulated Sta-Kon terminals!

12-Ton hydraulic head

Cat. no.	Description	Pkg. qty.
13400	12-ton crimping tool supplied with adapter TBM12D-AR; used for installing both insulated and non-insulated Sta-Kon terminals #8 AWG to 250 kcmil (dies ordered separately)	1



Military listed and 12 tons of crimping power.

12-Ton crimping tool (military spec. MS25441-1)

Cat. no.	Description	Pkg. qty.
13642M	Hydraulic-operated 12-ton tool; installs #8 AWG to 250 kcmil Sta-Kon terminals (dies ordered separately)	1

Diagram

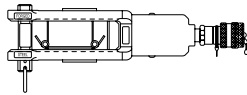

Hex dies for non-insulated Sta-Kon terminals to fit 13642M and 13400

Cat. no.	For tubular term	For brazed seam	Sta-Kon size	Wire size (AWG)	Hex die code
11732	—	—	D	8	21
—	11733	—	D	8	24
11733	—	—	E	6	24
—	11734	—	E	6	29
11734	—	—	F	4	29
—	11735	—	F	4	33
11736	—	—	G	2-1	37
11737	—	—	H	1/0	42
11738	—	—	J	2/0	45
11739	—	—	K	3/0	50
11740	—	—	L	4/0	54
11771	—	—	M	250 kcmil	62

Hex dies for non-insulated Sta-Kon terminals to fit 13642M (military listed)

Die cat. no.	Sta-Kon size	Wire size (AWG)	Pkg. qty.
11781M	D	8	1
11782M	E	6AN	1
11783M	F	4AN	1
11784M	G	2AN	1
11785M	H	1AN	1
11786M	J	1/0AN	1
11787M	K	2/0AN	1
11788M	L	3/0AN	1
11789M	M	4/0AN	1

Installing dies for insulated Sta-Kon terminals to fit 13642M (military listed)

Die cat. no.	Sta-Kon size	Wire size (AWG)	Pkg. qty.
21707M	RD	8	1
21708M	RE	6	1
21709M	RF	4	1
21710M	RG	2-1	1
21711M	RH	1/0	1
21712M	RJ	2/0	1
21713M	RK	3/0	1
21714M	RL	4/0	1
21715M	RM	250 kcmil	1

Indent-style dies for Sta-Kon brazed seam non-insulated terminals to fit 13642M and 13400

Nest cat. no.	Indent. cat. no.	Sta-Kon size	Wire size (AWG)	Pkg. qty.
13643	13650	D	8	1
13644	13650	E	6	1
13645	13650	F	4	1

Indent-style dies for Sta-Kon tubular non-insulated terminals to fit 13642M and 13400

Nest Cat. No.	Indent. cat. no.	Sta-Kon size	Wire size (AWG)	Pkg. qty.
13654	13650	G	2-1	1
13655	13650	H	1/0	1
13656	13650	J	2/0	1
13657	13650	K	3/0	1
13658	13650	L	4/0	1
13659	13650	M	250 kcmil	1

Indent-style dies for flag type Sta-Kon terminals — use with 13642M and 13400

Nest cat. no.	Indent. cat. no.	Sta-Kon size	Wire size (AWG)	Pkg. qty.
21733	21731	D	8	1
21734	21731	E	6	1
21735	21731	F	4	1
21736	21732	G	2	1
21737	21732	H	1	1
21738	21732	J	1/0	1
21739**	21732	K	2/0	1
21740**	21732	L	3/0	1
21741**	21732	M	4/0	1

** Cat. nos. 21739, 21740 and 21741 dies must be left in 13642M head with 21732 indenter when gauging

Application tools

Hydraulic pumps



- Designed for use with single-acting cylinders and tools rated for 10,000-psi operation
- Supplied with metal carrying case
- 13620 hand switch and 13619 hydraulic hose, both sold separately, required for operation

Specifications

- Motor: ½ hp, 115 V 50–60 Hz, 10 amps
- Pumping Capacity:
 - 170 cu. in./min. at 100 psi
 - 32 cu. in./min. at 1,000 psi
 - 25 cu. in./min. at 5,000 psi
 - 18 cu. in./min. at 10,000 psi
- Reservoir volume: 104 cu. in. (0.45 gal.)
- Basic pump dimension: 6 in. x 8 in. x 16 in.
- Weight: 25 lb

13600 Electric hydraulic pump

Cat. no.	Description	Pkg. qty.
13600	Electric hydraulic pump – hand or foot switch and non-metallic hose (sold separately) required for operation	1



- Shure-Stake control mechanism requires 9,800-psi pump pressure before recycling to prevent under-crimping
- Designed for use with single-acting cylinders and tools rated for 10,000-psi operation
- Supplied with metal carrying case

Specifications

- Motor rating: ½ hp, 115 V, 50–60 Hz, 12.5 amps
- Pumping capacity:
 - 170 cu. in./min. at 100 psi
 - 32 cu. in./min. at 1,000 psi
 - 25 cu. in./min. at 5,000 psi
 - 18 cu. in./min. at 10,000 psi
- Reservoir volume: 104 cu. in. (0.45 gal.)
- Basic pump dimension: 8½ in. x 10½ in. x 16 in.
- Weight: 35 lb

13610A Electric hydraulic pump with Shure-Stake control

Cat. no.	Description	Pkg. qty.
13610A	Electric hydraulic pump with Shure-Stake control – hand or foot switch and non-metallic hose (sold separately) required for operation	1

Application tools

Hydraulic pumps



- Designed for perfect crimps every time in heavy-duty OEM applications
- Heavy-duty OEM two-stage pump with high flow rate
- Shure-Stake control mechanism requires 9,800-psi pump pressure before recycling to prevent under-crimping
- Requires hand or foot control (sold separately)

Specifications

- Motor rating: 1½ hp, 115 V, 60 Hz, 23 amps
- Pumping capacity:
235 cu.in./min. at 200 psi
6 cu.in./min. at 8,000 psi
- Reservoir volume: 462 cu.in./2 gal.
- Dimensions (L x W x H): 10¾ in. x 15 in. x 20¾ in.
- Weight: 60 lb

13810 Heavy-duty electric hydraulic pump with Shure-Stake control

Cat. no.	Description	Pkg. qty.
13810	Heavy-duty electric hydraulic pump with Shure-Stake control – hand or foot switch and non-metallic hose (sold separately) required for operation	1

Accessories for electric hydraulic pumps

Cat. no.	Description	Pkg. qty.
For 13600		
13620	Hand switch	1
13589A	Foot switch	1
13619	10-ft. Non-metallic hose	1
13618	20-ft. Non-metallic hose	1
13600S	“Sled” type stand for 13600 pump	1
For 13610A and 13810		
13611	Hand switch	1
13612	Foot switch	1
13619	10-ft. Non-metallic hose	1

Die selection chart

Critical information for determining the products you need.

Product selection guide

Type	Terminal series	Pliers					Ergonomic ratchet hand tools						Ratchet hand tools			
		WT110M	WT111M	WT112M	WT161M	WT2000	ERG4001	ERG4002	ERG4004	ERG4005	ERG4006	ERG4255	WT1377	WT145A	WT145C	WT2130A
Nylon terminals	RZ	-	-	-	-	-	-	-	-	-	•	-	-	-	-	-
	RA, RAX	-	-	•	-	•	•	-	-	-	-	-	-	•	•	-
	RB	-	-	•	-	•	•	-	-	-	-	-	-	•	•	-
	RBC, RC	-	-	•	-	•	•	-	-	-	-	-	-	•	•	•
Nylon butt splices	RA	-	-	•	-	•	•	-	-	-	-	-	-	-	•	-
	RB	-	-	•	-	•	•	-	-	-	-	-	-	-	•	-
	RC	-	-	•	-	•	•	-	-	-	-	-	-	-	•	•
Nylon parallel splices	RAA	-	-	-	-	•	-	-	-	-	-	-	-	-	-	-
	RBB	-	-	-	-	•	-	-	-	-	-	-	-	-	-	-
	RCC	-	-	-	-	•	-	-	-	-	-	-	-	-	-	-
All nylon disconnects (except 0.110 size)	RA	-	-	•	-	•	•	-	-	-	-	-	-	-	•	-
	RB	-	-	•	-	•	•	-	-	-	-	-	-	-	•	-
	RC	-	-	•	-	•	•	-	-	-	-	-	-	-	•	•
Heat-shrinkable terminals, splices & disconnects	RAS	-	-	-	-	-	-	-	-	-	-	•	-	-	-	-
	RBS	-	-	-	-	-	-	-	-	-	-	•	-	-	-	-
	RCS	-	-	-	-	-	-	-	-	-	-	•	-	-	-	-
Vinyl terminals and splices	RA, RAA	-	-	•	-	•	•	-	-	-	-	-	-	-	•	-
	RB, RBB	-	-	•	-	•	•	-	-	-	-	-	-	-	•	-
	RC, RCC, RBC	-	-	•	-	•	•	-	-	-	-	-	-	-	•	•
Bare terminals and splices	A, AA	•	•	•	•	•	-	•	-	-	-	-	-	-	-	-
	B, BB	•	•	•	•	•	-	•	-	•	-	-	-	-	-	-
	C, CC	•	•	•	•	•	-	•	-	•	-	-	-	-	-	-
Wire joints	RB	-	-	•	-	•	•	-	-	-	-	-	-	-	-	•
	RC	-	-	•	-	•	-	-	-	-	-	-	-	-	•	-
	RP	-	-	•	-	•	-	-	-	-	-	-	-	-	•	-
	PT	-	•	-	•	-	-	-	-	-	-	-	-	-	-	-
Hi-temp terminals and splices	NW-rings	-	-	-	-	-	-	-	-	-	-	-	•	-	-	-
	NW-splices	-	-	-	-	-	-	-	-	-	-	-	•	-	-	-
Insulation grip	A	•	-	-	-	-	-	-	-	-	-	-	-	-	-	-
	B	•	-	-	-	-	-	-	-	-	-	-	-	-	-	-
0.110 disconnects	A, B	•	•	•	-	-	-	-	-	-	-	-	-	-	-	-
	RA, RB	-	-	-	-	-	-	-	-	-	•	-	-	-	-	-
Flag terminals	AB	-	-	-	-	-	-	-	•	-	-	-	-	-	-	-
	C	-	-	-	-	-	-	-	•	-	-	-	-	-	-	-
Tefzel terminals and splices	RAT, RAAT	-	-	•	-	•	-	-	-	-	-	-	-	-	•	-
	RB, RBBT	-	-	•	-	•	-	-	-	-	-	-	-	-	•	-
	RC, RCCT	-	-	•	-	•	-	-	-	-	-	-	-	-	•	-
Vinyl disconnects	RA	-	-	•	-	•	•	-	-	-	-	-	-	-	•	-
	RB	-	-	•	-	•	•	-	-	-	-	-	-	-	•	-
	RC	-	-	•	-	•	•	-	-	-	-	-	-	-	•	•
Bare disconnects	A	•	•	•	•	•	-	•	-	-	-	-	-	-	-	-
	B	•	•	•	•	•	-	•	-	•	-	-	-	-	-	-
	C	•	•	•	•	•	-	•	-	•	-	-	-	-	-	-

Tefzel is a registered trademark of DuPont.

Die selection chart

Critical information for determining the products you need.

Product selection guide

Type	Terminal series	BAT22-6NV2 / BAIR22-6/ PAIR22-6				12050 Mylar tape auto tool								
		DIE2001	DIE2002	DIE2005	DIE2009	12051	12052	12054	12055	12056	12057	12058	12059	12060
Nylon terminals	RZ	-	-	-	-	-	-	-	-	-	-	-	-	-
	RA, RAX	•	-	-	-	•	-	•	-	-	-	-	-	-
	RB	•	-	-	-	-	•	-	•	-	-	-	-	-
	RBC, RC	•	-	-	-	-	-	-	-	•	-	-	-	-
Nylon butt splices	RA	•	-	-	-	-	-	-	-	-	-	-	-	-
	RB	•	-	-	-	-	-	-	-	-	-	-	-	-
	RC	•	-	-	-	-	-	-	-	-	-	-	-	-
Nylon parallel splices	RAA	-	-	-	-	-	-	-	-	-	-	-	-	-
	RBB	-	-	-	-	-	-	-	-	-	-	-	-	-
	RCC	-	-	-	-	-	-	-	-	-	-	-	-	-
All nylon disconnects (except 0.110 size)	RA	•	-	-	-	•	-	•	-	-	-	-	-	-
	RB	•	-	-	-	-	•	-	•	-	-	-	-	-
	RC	•	-	-	-	-	-	-	-	•	-	-	-	-
Heat-shrinkable terminals, splices & disconnects	RAS	-	-	-	-	-	-	-	-	-	-	-	-	-
	RBS	-	-	-	-	-	-	-	-	-	-	-	-	-
	RCS	-	-	-	-	-	-	-	-	-	-	-	-	-
Vinyl terminals and splices	RA, RAA	•	-	-	-	-	-	•	-	-	-	-	-	-
	RB, RBB	•	-	-	-	-	-	-	•	-	-	-	-	-
	RC, RCC, RBC	•	-	-	-	-	-	-	-	•	-	-	-	-
Bare terminals and splices	A, AA	-	•	-	-	-	-	-	-	-	•	-	-	-
	B, BB	-	•	•	-	-	-	-	-	-	-	•	-	-
	C, CC	-	•	•	-	-	-	-	-	-	-	-	•	-
Wire joints	RB	•	-	-	•	-	-	-	-	-	-	-	-	-
	RC	-	-	-	•	-	-	-	-	-	-	-	-	-
	RP	-	-	-	•	-	-	-	-	-	-	-	-	-
	PT	-	-	-	-	-	-	-	-	-	-	-	-	-
Hi-temp terminals and splices	NW-rings	-	-	-	-	-	-	-	-	-	-	-	-	-
	NW-splices	-	-	-	-	-	-	-	-	-	-	-	-	-
Insulation grip	A	-	-	-	-	-	-	-	-	-	-	-	-	-
	B	-	-	-	-	-	-	-	-	-	-	-	-	-
0.110 disconnects	A, B	-	-	-	-	-	-	-	-	-	-	-	-	-
	RA, RB	-	-	-	-	-	-	-	-	-	-	-	-	-
Flag terminals	AB	-	-	-	-	-	-	-	-	-	-	-	-	-
	C	-	-	-	-	-	-	-	-	-	-	-	-	-
Tefzel terminals and splices	RAT, RAAT	-	-	-	-	-	-	-	-	-	-	-	-	-
	RB, RBBT	-	-	-	-	-	-	-	-	-	-	-	-	-
	RC, RCCT	-	-	-	-	-	-	-	-	-	-	-	-	-
Vinyl disconnects	RA	•	-	-	-	-	-	•	-	-	-	-	-	-
	RB	•	-	-	-	-	-	-	•	-	-	-	-	-
	RC	•	-	-	-	-	-	-	-	•	-	-	-	-
Bare disconnects	A	-	•	-	-	-	-	-	-	-	•	-	-	-
	B	-	•	•	-	-	-	-	-	-	-	•	-	-
	C	-	•	•	-	-	-	-	-	-	-	-	-	•

Tefzel is a registered trademark of DuPont.

Die selection chart

Select the die numbers you need.

Terminal Description	Series	Type	Hand tool with dies	TBM6 toggle hand tool TBM6S toggle hand tool die Cat. nos.		BPI42300CR, BPLT6BSCR and BPLT62BSCR crimp tools		13642M (MS25441-1) and 13400 hydraulic tool		
				Nest (stationary)	Indentor (movable)	Hex dies	Die code	Hex dies	Nest	Indentor
Non-insulated terminals and splices	D	Tubular	ERG4005	11803	11802	—	—	11781M*	13651	13650**
	D	Tubular	ERG4008	11803	11802	—	—	11781M*	13651	13650**
	D	Tubular	WT3185/WT115A	11803	11802	TBM6221	21	11732	13651	13650**
	D	Brazed	WT3185/WT115A	11803	11802	TBM6224	24	11733	13643	13650**
	E	Tubular	ERG4005	11803	11802	—	—	11782M	13652	13650**
	E	Tubular	ERG4008	11803	11802	—	—	11782M	13652	13650**
	E	Tubular	WT3185/WT115A	11803	11802	TBM6224	24	11733*	13652	13650**
	E	Brazed	WT3185/WT115A	11804	11802	TBM6229	29	11734	13644	13650**
	F	Tubular	ERG4008	11805	11802	—	—	11783	13653	13650**
	F	Tubular	WT3185/WT115A	11805	11802	TBM6229	29	11734*	13653	13650**
	F	Brazed	WT3185/WT115A	11806	11802	TBM6233	33	11735	13645	13650**
	G	Tubular	ERG4008	11806	11802	—	—	11784M*	13654	13650**
	G	Tubular	WT3185/WT115A	11806	11802	TBM6237	37	11736	13654	13650**
	H	Tubular	ERG4008	11807	11802	—	—	11785M*	13655	13650**
	H	Tubular	WT3185	11807	11802	—	—	11785M*	13655	13650**
	H	Tubular	WT3185	11807	11802	TBM6242	42	11737	13655	13650**
	J	Tubular	WT3185	11808	11802	—	—	11786M*	13656	13650**
	J	Tubular	WT3185	11808	11802	TBM6245	45	11738	13656	13650**
	K	Tubular	—	11809	11802	—	—	11787M*	13657	13650**
	K	Tubular	—	11809	11802	TBM6250	50	11739	13657	13650**
L	Tubular	—	11810	11802	—	50	11788M*	13658	13650**	
L	Tubular	—	11810	11802	TBM6254	54	11740	13658	13650**	
M	Tubular	—	11811	11802	—	54	11789M*	13659	13650**	
M	Tubular	—	11811	11802	TBM6262	62	11771	13659	13650**	
Tefzel ¹ nylon insulated terminals and splices	RD	Tubular	ERG4007	11821 (Set)	11821 (Set)	—	—	21707M* (Set)		
	RD	Brazed & tubular	—	11822 (Set)	11822 (Set)	—	—	21708M* (Set)		
	RE	Tubular	ERG4007	11822 (Set)	11822 (Set)	—	—	21708M* (Set)		
	RE	Brazed	—	11823 (Set)	11823 (Set)	—	—	21709M* (Set)		
	RF	Tubular	—	11823 (Set)	11823 (Set)	—	—	21709M* (Set)		
	RF	Brazed	—	11824 (Set)	11824 (Set)	—	—	21710M* (Set)		
	RG	Tubular	—	11824 (Set)	11824 (Set)	—	—	21710M* (Set)		
	RH	Tubular	—	11825 (Set)	11825 (Set)	—	—	21711M* (Set)		
	RJ	Tubular	—	11826 (Set)	11826 (Set)	—	—	21712M* (Set)		
	RK	Tubular	—	11827 (Set)	11827 (Set)	—	—	21713M* (Set)		
RL	Tubular	—	11828 (Set)	11828 (Set)	—	—	21714M* (Set)			
RM	Tubular	—	11829 (Set)	11829 (Set)	—	—	21715M* (Set)			
Non-insulated flag terminals	D	—	WT129	—	—	—	—	21733	21731	
	E	—	WT129	—	—	—	—	21734	21731	
	F	—	WT129	—	—	—	—	21735	21731	
	G	—	WT129	—	—	—	—	21736	21732	
	H	—	—	—	—	—	—	21737	21732	
	J	—	—	—	—	—	—	21738	21732	
	K	—	—	—	—	—	—	21739	21732	
	L	—	—	—	—	—	—	21740	21732	
	M	—	—	—	—	—	—	21741	21732	

* Indicates military listed die.

** To order the military version, suffix the indentor catalogue number with an "M" (13650M). Nest catalogue number does not change.

¹Tefzel is a registered trademark of DuPont.

Wire guide table

Stud size and clearance hole chart

Stud size	2	4	6	8	10	¼	⅜	½	⅝	¾	⅞	1
Min. hole dia. (in.)	0.92	0.116	0.143	0.169	0.196	0.262	0.323	0.388	0.453	0.516	0.650	0.775
Min. hole dia. (mm)	2.337	2.946	3.632	4.292	4.978	6.655	8.204	9.855	11.506	13.106	16.510	19.685

Wire strip length chart

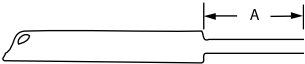
Diagram	Wire strip length	Terminal series	Recommend wire strip length "A" standard terminals (in.)
	Non-insulated	A	¼
		B	¼
		C, BC	5/16
	Vinyl insulated — Add 1/16 in. for funnel-entry type	RA	¼
		RB	¼
		RC, RBC	11/32
	Nylon-insulated and Tefzel insulated	RA	7/32
		RB	7/32
		RC, RBC	5/16
	Nylon-insulated and Tefzel insulated when using aircraft and code wire	RD	17/32
		RE	17/32
		RF	9/16
		RG	11/16
		RH	11/16
		RJ	¾
		RK	7/8
	Non-insulated, when using aircraft and code wire	RL	7/8
		RM	1
		D	15/32
		E	15/32
F		½	
G		41/64	
H		43/64	
J	47/64		
K	55/64		
L	55/64		
M	59/64		

Tefzel is a registered trademark of DuPont

Wire guide table

AWG or AN	Individual strands			Whole conductor		
	Navy shipboard†	No.	Dia. (in.)	Cir. mil. area	Dia. (in.)	Dia. (mm)
22 Wire size						
22	⅜ (1)	1	0.025	642	0.025	0.635
22	⅜ (7)	7	0.010	703	0.030	0.762
AN-22*		7	**	704	0.032	0.813
	½ (21)	21	0.005	525	0.028	0.711
20 Wire size						
20	1 (1)	1	0.032	1,022	0.032	0.813
20	–	7	0.012	1,024	0.036	0.914
20	–	10	0.010	1,005	0.040	1.016
20	–	19	0.007	1,022	0.037	0.940
20	–	26	0.006	1,034	0.039	0.991
AN-20*	–	7	**	1,119	0.040	1.016
–	1 (7)	7	0.013	1,119	0.038	0.965
–	1 (10)	10	0.010	1,005	0.038	0.965
–	1 (26)	26	0.006	1,034	0.042	1.067
18 Wire size						
18	1½ (1)	1	0.040	1,624	0.040	1.016
18	1½ (7)	7	0.016	1,624	0.049	1.245
18	1½ (16)	16	0.010	1,608	0.049	1.245
18	–	19	0.009	1,624	0.046	1.168
18	1½ (41)	41	0.006	1,630	0.049	1.245
AN-18*	2 (7)	7	0.016	1,779	0.048	1.219
16 Wire size						
16	2½ (1)	1	0.051	2,583	0.051	1.295
16	–	7	0.019	2,583	0.058	1.473
16	–	19	0.012	2,601	0.058	1.473
16	–	26	0.010	2,613	0.059	1.499
16	–	65	0.006	2,580	0.058	1.473
AN-16*	2½ (19)	19	0.011	2,407	0.061	1.549
	2½ (26)	26	0.010	2,613	0.061	1.549
14 Wire size						
14	–	1	0.064	4,107	0.064	1.626
14	–	7	0.024	4,107	0.073	1.854
14	–	19	0.015	4,107	0.074	1.880
14	–	37	0.011	4,107	0.074	1.880
14	–	14	0.009	4,157	0.083	2.108
14	–	104	0.006	4,128	0.074	1.880
AN-14*	–	19	**	3,830	0.076	1.930
–	3 (7)	7	0.020	2,828	0.060	1.524
–	3 (19)	19	0.013	3,036	0.063	1.600
–	4 (1)	1	0.064	4,107	0.064	1.626
–	4 (7)	7	0.025	4,497	0.076	1.930
–	4 (19)	19	0.014	3,828	0.072	1.829
–	4 (41)	41	0.010	4,121	0.077	1.956

AWG or AN	Individual strands			Whole conductor		
	Navy shipboard†	No.	Dia. (in.)	Cir. mil. area	Dia. (in.)	Dia. (mm)
12 Wire size						
12	–	1	0.081	6,530	0.081	2.057
12	–	7	0.031	6,530	0.092	2.337
12	–	19	0.019	6,530	0.093	2.362
12	–	37	0.013	6,530	0.093	2.362
12	–	49	0.012	6,593	0.104	2.642
12	–	65	0.010	6,533	0.093	2.362
12	–	104	0.008	6,574	0.094	2.388
12	–	165	0.006	6,559	0.095	2.413
AN-12*	6 (19)	19	0.018	6,088	0.096	2.438
–	6 (7)	7	0.031	6,512	0.092	2.337
–	6 (65)	65	0.010	6,533	0.097	2.964
10 Wire size						
10	–	1	0.102	10,380	0.102	2.591
10	–	7	0.039	10,380	0.116	2.946
10	–	19	0.023	10,380	0.117	2.972
10	–	37	0.017	10,443	0.117	2.972
10	–	49	0.015	10,445	0.131	2.327
10	–	104	0.010	10,452	0.116	2.946
AN-10*	–	37	**	10,380	0.117	2.972
–	9 (7)	7	0.036	9,016	0.108	2.743
–	9 (37)	37	0.016	9,402	0.109	2.769
–	9 (90)	90	0.010	9,045	0.120	3.048

* MIL-W-5086. ** Strand diameter not specified. † MIL-E-16366 A.

Wire guide table

AWG or AN	Individual strands		Whole conductor			
	Navy shipboard†	No.	Dia. (in.)	Cir. mil. area	Dia. (in.)	Dia. (mm)
9 Wire size						
9	–	7	0.043	13,090	0.130	3.302
	14 (7)	7	0.045	14,340	0.136	3.454
8 Wire size						
8	–	7	0.049	16,510	0.146	3.712
8	–	19	0.030	16,510	0.148	3.763
8	–	37	0.021	16,510	0.148	3.763
7 Wire size						
7	–	1	0.144	20,820	0.144	3.662
–	14 (7)	7	0.045	14,340	0.136	3.454
–	14 (140)	140	0.010	14,070	0.145	3.787
6 Wire size						
6	–	7	0.061	25,250	0.184	4.672
6	–	19	0.037	26,250	0.186	4.722
6	–	37	0.027	26,250	0.186	4.722
6	–	49	0.023	26,146	0.208	5.283
6	–	661	0.006	26,274	0.259	6.579
5 Wire size						
5	–	1	0.181	33,100	0.181	4.595
–	20 (49)	7x7	0.020	19,800	0.180	4.570
–	23 (7)	7	0.057	22,800	0.171	4.345
–	23 (228)	19x12	0.010	22,190	0.190	4.830
–	26 (49)	7x7	0.023	26,250	0.210	5.330
4 Wire size						
4	–	7	0.077	41,740	0.232	5.891
4	–	19	0.047	41,740	0.235	5.967
4	–	37	0.034	41,740	0.235	5.967
3 Wire size						
3	–	1	0.229	52,630	0.229	5.819
–	30 (304)	19x16	0.010	30,550	0.220	5.590
–	33 (336)	7x48	0.010	33,370	0.235	5.967
–	40 (19)	19	0.045	38,910	0.226	5.742
–	42 (49)	7x7	0.029	41,740	0.260	6.600
–	42 (209)	19x11	0.014	42,110	0.260	6.600
–	50 (19)	19	0.051	49,080	0.254	6.452

AWG or AN	Individual strands		Whole conductor			
	Navy shipboard†	No.	Dia. (in.)	Cir. mil. area	Dia. (in.)	Dia. (mm)
2 Wire size						
2	–	7	0.097	66,370	0.292	7.421
2	–	19	0.059	66,370	0.296	7.522
2	–	37	0.042	66,370	0.297	7.548
2	–	49	0.037	66,356	0.331	8.405
2	–	133	0.022	66,140	0.335	8.507
AN-2*	–	663	**	66,832	0.345	8.767
–	53 (532)	19x28	0.010	53,470	0.304	7.772
–	60 (37)	37	0.040	60,090	0.282	7.161
–	60 (304)	19x16	0.014	61,260	0.310	7.870
–	66 (133)	19x7	0.022	66,370	0.330	8.380
–	75 (37)	37	0.045	75,780	0.317	8.048
1 Wire size						
1	–	7	0.109	83,690	0.328	8.333
1	–	19	0.066	83,690	0.332	8.431
1	–	37	0.048	83,690	0.333	8.456
1	–	61	0.037	83,690	0.333	8.456
1	–	133	0.025	83,690	0.377	9.578
1	–	259	0.018	83,916	0.378	9.603
AN-1*	–	812	**	81,807	0.384	9.752
–	83 (418)	19x22	0.014	84,230	0.380	9.650
–	84 (2,107)	2107	**	83,690	0.410	10.41

* MIL-W-5086.

** Strand diameter not specified.

† MIL-E-16366 A

Wire guide table

AWG or AN	Navy shipboard†	Individual strands		Whole conductor		
		No.	Dia. (in.)	Cir. Mil. Area	Dia. (in.)	Dia. (mm)
1/0 Wire size						
1/0	–	7	0.123	105,500	0.368	9.343
1/0	–	19	0.075	105,500	0.373	9.476
1/0	–	37	0.053	105,500	0.374	9.502
1/0	–	61	0.042	105,500	0.374	9.502
1/0	–	133	0.028	105,761	0.423	10.721
1/0	–	259	0.020	105,672	0.424	10.772
AN-0*	–	1,033	**	104,118	0.432	10.971
–	100 (61)	61	0.040	99,060	0.363	9.216
–	105 (259)	37x7	**	105,500	0.410	10.410
2/0 Wire Size						
–	105 (2,646)	2,646	**	105,500	0.460	11.680
2/0	–	7	0.138	133,100	0.414	10.512
2/0	–	19	0.084	133,100	0.419	10.639
2/0	–	37	0.060	133,100	0.420	10.670
2/0	–	61	0.047	133,100	0.420	10.670
2/0	–	133	0.032	132,800	0.474	12.042
2/0	–	259	0.023	133,462	0.477	12.118
AN-00*	–	1,327	**	133,665	0.490	12.450
–	125 (61)	61	0.045	124,900	0.407	10.338
–	133 (259)	37x7	**	133,100	0.460	11.680
–	133 (684)	19x36	0.014	137,800	0.480	12.190
–	133 (3,325)	3,325	**	133,100	0.520	13.210
–	150 (61)	61	0.051	157,600	0.457	11.608
3/0 Wire size						
3/0	–	7	0.155	167,800	0.464	11.782
3/0	–	19	0.094	167,800	0.470	11.940
3/0	–	37	0.067	167,800	0.471	11.965
3/0	–	61	0.052	167,800	0.472	11.991
3/0	–	133	0.036	167,607	0.533	13.536
3/0	–	259	0.026	167,402	0.536	13.612
3/0	–	4,227	0.006	168,023	0.610	15.490
–	150 (760)	19x40	0.014	153,100	0.510	12.950
–	168 (427)	61x7	**	167,800	0.520	13.210

AWG or AN	Navy shipboard†	Individual strands		Whole conductor		
		No.	Dia. (in.)	Cir. Mil. Area	Dia. (in.)	Dia. (mm)
4/0 Wire size						
4/0	–	7	0.174	211,600	0.522	13.261
4/0	–	19	0.106	211,600	0.528	13.413
4/0	–	37	0.076	211,600	0.529	13.439
4/0	–	61	0.059	211,600	0.530	13.460
4/0	–	133	0.040	211,736	0.599	15.219
4/0	–	259	0.029	211,845	0.601	15.265
AN-000*	–	1,661	**	167,332	0.548	13.923
–	200 (61)	61	0.057	198,700	0.514	13.652
–	200 (988)	19x52	0.014	199,100	0.580	14.730
250 kcmil Wire size						
250,000	–	19	0.115	250,000	0.574	14.582
250,000	–	37	2	250,000	0.575	14.607
250,000	–	61	0.064	250,000	0.576	14.632
250,000	–	91	0.052	250,000	0.576	14.632
AN-0000*	–	2,104	**	211,954	0.615	15.617
–	220 (259)	37x7	0.029	220,700	0.610	15.490
–	250 (61)	61	0.064	250,000	0.577	14.658

* MIL-W-5086.

** Strand diameter not specified.

†MIL-E-16366 A

Military standard cross reference

MIL-T-7928 MS-25036	Cat. no. ABB Class 1 & 2
-101	RA333
-102	RA853
-103	RA873
-104	RA723
-105	RA733
-106	RB1333
-107	RB853
-108	RB873
-109	RB723
-110	RB733
-111	RC333
-112	RC363
-113	RC703
-114	RC733
-115	RD10361
-116	RD10711
-117	RD10721
-118	RD10731
-119	RE10261
-120	RE10711
-121	RE10721
-122	RE10731
-123	RF10711
-124	RF10721
-125	RF10731
-126	RG9711
-127	RG9731
-128	RG9751
-129	RH9711
-130	RH9731
-131	RH9751
-132	RJ9711
-133	RJ9731
-135	RK9721
-136	RK9731
-137	RK9751
-138	RL9731
-139	RL9751
-140	RM9731
-141	RM9751
-142	—
-143	—
-144	—
-145	—
-146	—
-147	—
-148	RA323
-149	RA863
-150	RA713
-151	RA753

MIL-T-7928 MS-25036	Cat. no. ABB Class 1 & 2
-152	RB1323
-153	RB863
-154	RB713
-155	RB753
-156	RC863
-157	RC713
-158	RC753

MIL-T-7928 MS-20659	Cat. no. ABB
-101	A85G
-102	A87G
-103	B85G
-104	B87G
-105	C26
-106	C70
-107	D10361
-108	D10721
-109	E10711
-110	E10731
-111	F10711
-112	F10731
-113	G971
-114	G973
-115	H971
-116	H973
-117	J971
-118	J973
-119	K972
-120	K973
-121	L973
-122	L975
-123	M973
-124	M975
-128	C73
-129	D10731
-130	E10261
-131	E10721
-132	F10721
-133	G975
-134	H975
-135	J975
-136	K975
-140	D10161
-141	D10711
-144	F10261
-146	G926
-147	G972

MIL-T-7928 MS-20659	Cat. no. ABB
-148	G974
-149	H972
-151	J972
-152	J974
-153	K971
-154	K974
-155	L972
-156	L974
-157	M972
-158	M974
-165	C33
-166	C75

MIL-T-22909 MS-90485	Cat. no. ABB
-8	11781M
-6	11782M
-4	11783M
-2	11784M
-1	11785M
-01	11786M
-02	11787M
-03	11788M
-04	11789M

MIL-T-7928 MS-17143	Cat. no. ABB
-1	RA480
-2	RB480
-3	RC480
-4	RA481
-5	RB481
-6	RC481
-7	RA482
-8	RB482
-9	RC482
-10	RA483
-11	RB483
-12	RC483
-13	RA484
-14	RB484
-15	RC484
-16	RA485
-17	RB485
-19	RA486
-20	RB486

MIL-T-7928 MS-21004	Cat. no. ABB
-1	A486
-2	A483
-3	A482
-4	A481
-5	A485
-6	A484
-7	A480
-8	B486
-9	B483
-10	B482
-11	B481
-12	B485
-13	B484
-14	B480
-15	C486
-16	C483
-17	C482
-18	C481
-19	C485
-20	C484
-21	C480

MIL-T-22909 MS-23002	Cat. no. ABB
-8	21707M
-6	21708M
-4	21709M
-2	21710M
-1	21711M
-01	21712M
-02	21713M
-03	21714M
-04	21715M

Packaging cross reference

Cat. no. ABB distributor package	Cat. no. ABB bulk package	Cat. no. ABB distributor package	Cat. no. ABB bulk package	Cat. no. ABB distributor package	Cat. no. ABB bulk package	Cat. no. ABB distributor package	Cat. no. ABB bulk package
10RC-10	RC367	14RB-8	RB867	2B-16	RBB25	B14-10G	B87G
10RC-10F	RC1157	14RB-8F	RB657	2B18-16	B1B	B14-110F	B10TB
10RC-10FL	RC2227	14RB-8FL	RB2237	2C-10	CC2-TB	B14-111F	B11-TB
10RC-10FLX	RC2227-250	14RB-8FLX	RB2237-200	2C-12	RCC26	B14-12	B75TB
10RC-10FX	RC1157-250	14RB-8FX	RB657-200	2C14-12	C1C	B14-14	B71
10RC-10X	RC367-250	14RB-8X	RB867-200	2D10-9	D1D	B14-250	B250
10RC-14	RC717	14RBC-10	RBC877	2D-8	DD102	B14-250A	B252G
10RC-14F	RC1167	14RBC-12	RBC757	2E-6	EE2	B14-250F	B250G
10RC-14FL	RC2237	14RBC-14	RBC717	2E8-7	E1E	B14-250T	B251G
10RC-14X	RC717-250	14RBC-38	RBC797	2F-4	FF2	B14-251T	B251
10RC-250F	RC257	14RBC-516	RBC727	2F6-5	F1F	B14-38	B73
10RC-250T	RC2517	14RBC-6	RBC857	2G21	GG2	B14-4	B132
10RC-251T	RC25177	14RBC-8	RBC867	2G4-2	G1G	B14-516	B72
10RC-2577	RC2573	14RBD-182	RBD1827	2RA18	RAA21	B14-6	B133
10RC-38	RC737	14RBD-18277	RBD18277	2RA18X	RAA217-170	B14-6F	B64
10RC-38X	RC737-250	14RBD-183	RBD1837	2RAA	RAA23	B14-6FL	B220
10RC-516	RC707	14RBD-18377	RBD18377	2RB14	RBB21	B14-6FS	B19
10RC-55PT	RC55PT	18RA-10	RA877	2RB14X	RBB217-200	B14-8	B86
10RC-6	RC337	18RA-10F	RA1157	2RBB	RBB23	B14-8F	B65TB
10RC-6F	RC1337	18RA-10FL	RA2257	2RC10	RCC21	B14-8FL	B223
10RC-6FL	RC2207	18RA-10FLX	RA2257-170	2RC10X	RCC217-250	B14-D	B23
10RC-6FLX	RC2207-250	18RA-14	RA717	2RCC	RCC23	BC14-10	BC87
10RC-6X	RC337-250	18RA-250F	RA257	2RD8	RDD27	BC14-12	BC75
10RC-8	RC777	18RA-250T	RA2517	2RE6	REE28	BC14-14	BC71
10RC-8F	RC1147	18RA-251T	RA25177	A18-10	A87	BC14-38	BC79
10RC-8FL	RC2217	18RA-2577	RA2573	A18-10F	A115-TB	BC14-516	BC72
10RC-8FLX	RC2217-250	18RA-38	RA737	A18-10FL	A225	BC14-6	BC85
10RC-8X	RC777-250	18RA-4	RA77	A18-110F	A10-TB	BC14-8	BC86
14RB-10	RB877	18RA-47PT	RA47PT	A18-111F	A11	BD14-183	BD183
14RB-10F	RB1157	18RA-516	RA727	A18-12	A75	C10-10	C26
14RB-10FL	RB2257	18RA-516X	RA727-170	A18-14	A71	C10-10A	C53
14RB-10FLX	RB2257-200	18RA-6	RA857	A18-250	A250-TB	C10-10F	C115
14RB-10FX	RB1157-200	18RA-6F	RA1167	A18-250A	A252G	C10-10FL	C222-TB
14RB-10X	RB877-200	18RA-6FL	RA2217	A18-251T	A251	C10-12	C75
14RB-14	RB717	18RA-6FLX	RA2217-170	A18-38	A73	C10-14	C71
14RB-14X	RB717-200	18RA-6FX	RA1167-170	A18-516	A72	C10-14F	C116-TB
14RB-250F	RB257	18RA-6X	RA857-170	A18-6	A85	C10-250A	C252G
14RB-250T	RB2517	18RA-8	RA867	A18-6F	A116	C10-250F	C250
14RB-251T	RB25177	18RA-8F	RA1147	A18-6FL	A221	C10-38	C73
14RB-2577	RB2573	18RA-8FL	RA2247	A18-8	A86	C10-516	C70
14RB-38	RB737	18RA-8FX	RA1147-170	A18-8F	A114	C10-6A	C51
14RB-4	RB1327	18RA-8X	RA867-170	A18-8FL	A224	C10-6F	C133
14RB-47PT	RB47PT	18RAD-182	RAD1827	AB14-10A	AB53	C10-6FL	C220-TB
14RB-516	RB727	18RAD-18277	RAD18277	AB14-6A	AB51	C10-6-SK	C33
14RB-6	RB857	18RAD-183	RAD1837	AB14-8A	AB52	C10-8A	C52-TB
14RB-6F	RB647	18RAD-18377	RAD18377	AD18-182	AD182	C10-8F	C114
14RB-6FL	RB2207	2A-18	AA2	AD18-183	AD183	C10-8FL	C221
14RB-6FLX	RB2207-200	2A20	RAA24	B14-10	B87	C10-8-SK	C77
14RB-6FX	RB647-200	2A22-20	A1A	B14-10F	B115	D8-10	D36
14RB-6X	RB857-200	2B-14	BB2	B14-10FL	B225	D8-12	D75

Packaging cross reference

Cat. no. ABB distributor package	Cat. no. ABB bulk package	Cat. no. ABB distributor package	Cat. no. ABB bulk package	Cat. no. ABB distributor package	Cat. no. ABB bulk package	Cat. no. ABB distributor package	Cat. no. ABB bulk package
D8-14-SK	D71	RA18-8FS	RA1223	RC10-250A	RC2577F	A73	A18-38
D8-38	D73	RA18D	RA23	RC10-250F	RC250	A75	A18-12
D8-516	D72	RAD18-182	RAD1823	RC10-38	RC733	A85	A18-6
E6-10	E26	RAD18-183	RAD1833	RC10-38X	RC734	A86	A18-8
E6-12	E75	RB14-10	RB873	RC10-516	RC703	A87	A18-10
E6-14	E71	RB14-10F	RB1153	RC10-55PT	RC155PT	AA2	2A-18
E6-38	E73	RB14-10FL	RB2253	RC10-6	RC333	AB51	AB14-6A
E6-516	E72	RB14-10FS	RB1253	RC10-6F	RC1113	AB52	AB14-8A
F250TA	FTA250	RB14-10X	RB874	RC10-6FL	RC2203	AB53	AB14-10A
F4-10	F26	RB14-110F	RB10-SK	RC10-8	RC863	AD182	AD18-182
F4-12	F75	RB14-111F	RB11-TB	RC10-8F	RC1123	AD183	AD18-183
F4-14	F71-TB	RB14-12	RB753	RC10-8FL	RC2213	B10TB	B14-110F
F4-38	F73	RB14-14	RB713	RC10-8FS	RC1223	B115	B14-10F
F4-516	F72	RB14-14F	RB1163	RC10-8X	RC864	B11-TB	B14-111F
G2-12	G975	RB14-14X	RB714	RC55	RC6	B132	B14-4
G2-14	G971	RB14-250	RBB250	RD8-10	RD367	B133	B14-6
G2-38	G973	RB14-250A	RB2577F	RD8-12	RD757	B19	B14-6FS
G2-516	G972	RB14-250F	RB250	RD8-14	RD717	B1B 2	B18-16
H10-14	H971	RB14-250FP	RB250P	RD8-38	RD737	B220	B14-6FL
J20-38	J973	RB14-38	RB733	RD8-516	RD727	B223	B14-8FL
K30-38	K973	RB14-38X	RB734	RE6-10	RE267	B225	B14-10FL
L40-38	L973	RB14-4	RB1323	RE6-12	RE757	B23	B14-D
M250-38	M973	RB14-47PT	RB147PT	RE6-14	RE717	B250	B14-250
NW14-10	NW83	RB14-516	RB723	RE6-38	RE737	B250G	B14-250F
NW14-12	NW84	RB14-516X	RB724	RE6-516	RE727	B251	B14-251T
NW14-6	NW81	RB14-6	RB853	RF4-10	RF267	B251G	B14-250T
NW22-10	NW23	RB14-6F	RB1113	RF4-12	RF757	B252G	B14-250A
RA18-10	RA873	RB14-6FL	RB2213	RF4-14	RF717	B64	B14-6F
RA18-10F	RA1153	RB14-6FS	RB1203	RF4-38	RF737	B65TB	B14-8F
RA18-10FL	RA2253	RB14-6X	RB854	RF4-516	RF727	B71	B14-14
RA18-10FS	RA1253	RB14-8	RB863	RG2-10	RG267	B72	B14-516
RA18-110F	RA10SK	RB14-8F	RB1123	RG2-12	RG757	B73	B14-38
RA18-111F	RA11	RB14-8FL	RB2233	RG2-14	RG717	B75TB	B14-12
RA18-12	RA753	RB14-8FS	RB1223	RG2-38	RG737	B86	B14-8
RA18-14	RA713	RB14-8X	RB864	RG2-516	RG727	B87	B14-10
RA18-14F	RA1163	RB44	RB4-TB	RP12	RP7	B87G	B14-10G
RA18-250A	RA2577F	RBC14-14	RBC713	A10-TB	A18-110F	BB2	2B-14
RA18-250F	RA250TB	RBC14-516	RBC723	A11	A18-111F	BC71	BC14-14
RA18-250FP	RA250P	RBD14-182	RBD1823	A114	A18-8F	BC72	BC14-516
RA18-38	RA733	RBD14-183	RBD1833	A115-TB	A18-10F	BC75	BC14-12
RA18-4	RA323	RC10-10	RC363	A116	A18-6F	BC79	BC14-38
RA18-47PT	RA147PT	RC10-10F	RC1153	A1A 2	A22-20	BC85	BC14-6
RA18-516	RA723	RC10-10FL	RC2223	A221	A18-6FL	BC86	BC14-8
RA18-6	RA853	RC10-10FS	RC1253	A224	A18-8FL	BC87	BC14-10
RA18-6F	RA1103	RC10-10X	RC364	A225	A18-10FL	BD183	BD14-183
RA18-6FL	RA2213	RC10-12	RC753	A250-TB	A18-250	C114	C10-8F
RA18-6FS	RA1203	RC10-14	RC713	A251	A18-251T	C115	C10-10F
RA18-8	RA863	RC10-14F	RC1163	A252G	A18-250A	C116-TB	C10-14F
RA18-8F	RA1123	RC10-14FL	RC2233	A71	A18-14	C133	C10-6F
RA18-8FL	RA2243	RC10-14X	RC714	A72	A18-516	C1C 2	C14-12

Packaging cross reference

Cat. no. ABB distributor package	Cat. no. ABB bulk package	Cat. no. ABB distributor package	Cat. no. ABB bulk package	Cat. no. ABB distributor package	Cat. no. ABB bulk package	Cat. no. ABB distributor package	Cat. no. ABB bulk package
C220-TB	C10-6FL	NW81	NW14-6	RA867-170	18RA-8X	RB714	RB14-14X
C221	C10-8FL	NW83	NW14-10	RA873	RA18-10	RB717	14RB-14
C222-TB	C10-10FL	NW84	NW14-12	RA877	18RA-10	RB717-200	14RB-14X
C250	C10-250F	RA10SK	RA18-110F	RAA21	2RA18	RB723	RB14-516
C252G	C10-250A	RA11	RA18-111F	RAA217-170	2RA18X	RB724	RB14-516X
C26	C10-10	RA1103	RA18-6F	RAA23	2RAA	RB727	14RB-516
C33	C10-6-SK	RA1123	RA18-8F	RAA24	2A20	RB733	RB14-38
C51	C10-6A	RA1147	18RA-8F	RAD1823	RAD18-182	RB734	RB14-38X
C52-TB	C10-8A	RA1147-170	18RA-8FX	RAD1827	18RAD-182	RB737	14RB-38
C53	C10-10A	RA1153	RA18-10F	RAD18277	18RAD-18277	RB753	RB14-12
C70	C10-516	RA1157	18RA-10F	RAD1833	RAD18-183	RB853	RB14-6
C71	C10-14	RA1163	RA18-14F	RAD1837	18RAD-183	RB854	RB14-6X
C73	C10-38	RA1167	18RA-6F	RAD18377	18RAD-18377	RB857	14RB-6
C75	C10-12	RA1167-170	18RA-6FX	RB10-SK	RB14-110F	RB857-200	14RB-6X
C77	C10-8-SK	RA1203	RA18-6FS	RB1113	RB14-6F	RB863	RB14-8
CC2-TB	2C-10	RA1223	RA18-8FS	RB1123	RB14-8F	RB864	RB14-8X
D1D	2D10-9	RA1253	RA18-10FS	RB1153	RB14-10F	RB867	14RB-8
D36	D8-10	RA147PT	RA18-47PT	RB1157	14RB-10F	RB867-200	14RB-8X
D71	D8-14-SK	RA2213	RA18-6FL	RB1157-200	14RB-10FX	RB873	RB14-10
D72	D8-516	RA2217	18RA-6FL	RB1163	RB14-14F	RB874	RB14-10X
D73	D8-38	RA2217-170	18RA-6FLX	RB11-TB	RB14-111F	RB877	14RB-10
D75	D8-12	RA2243	RA18-8FL	RB1203	RB14-6FS	RB877-200	14RB-10X
DD102	2D-8	RA2247	18RA-8FL	RB1223	RB14-8FS	RBB21	2RB14
E1E	2E8-7	RA2253	RA18-10FL	RB1253	RB14-10FS	RBB217-200	2RB14X
E26	E6-10	RA2257	18RA-10FL	RB1323	RB14-4	RBB23	2RBB
E71	E6-14	RA2257-170	18RA-10FLX	RB1327	14RB-4	RBB25	2B-16
E72	E6-516	RA23	RA18D	RB147PT	RB14-47PT	RBB250	RB14-250
E73	E6-38	RA250P	RA18-250FP	RB2207	14RB-6FL	RBC713	RBC14-14
E75	E6-12	RA250TB	RA18-250F	RB2207-200	14RB-6FLX	RBC717	14RBC-14
EE2	2E-6	RA2517	18RA-250T	RB2213	RB14-6FL	RBC723	RBC14-516
F1F	2F6-5	RA25177	18RA-251T	RB2233	RB14-8FL	RBC727	14RBC-516
F26	F4-10	RA257	18RA-250F	RB2237	14RB-8FL	RBC757	14RBC-12
F71-TB	F4-14	RA2573	18RA-2577	RB2237-200	14RB-8FLX	RBC797	14RBC-38
F72	F4-516	RA2577F	RA18-250A	RB2253	RB14-10FL	RBC857	14RBC-6
F73	F4-38	RA323	RA18-4	RB2257	14RB-10FL	RBC867	14RBC-8
F75	F4-12	RA47PT	18RA-47PT	RB2257-200	14RB-10FLX	RBC877	14RBC-10
FF2	2F-4	RA713	RA18-14	RB250	RB14-250F	RBD1823	RBD14-182
FTA250	F250TA	RA717	18RA-14	RB250P	RB14-250FP	RBD1827	14RBD-182
G1G	2G4-2	RA723	RA18-516	RB2517	14RB-250T	RBD18277	14RBD-18277
G971	G2-14	RA727	18RA-516	RB25177	14RB-251T	RBD1833	RBD14-183
G972	G2-516	RA727-170	18RA-516X	RB257	14RB-250F	RBD1837	14RBD-183
G973	G2-38	RA733	RA18-38	RB2573	14RB-2577	RBD18377	14RBD-18377
G975	G2-12	RA737	18RA-38	RB2577F	RB14-250A	RC1113	RC10-6F
GG2	2G21	RA753	RA18-12	RB47PT	14RB-47PT	RC1123	RC10-8F
H971	H10-14	RA77	18RA-4	RB4-TB	RB44	RC1147	10RC-8F
J973	J20-38	RA853	RA18-6	RB647	14RB-6F	RC1153	RC10-10F
K973	K30-38	RA857	18RA-6	RB647-200	14RB-6FX	RC1157	10RC-10F
L973	L40-38	RA857-170	18RA-6X	RB657	14RB-8F	RC1157-250	10RC-10FX
M973	M250-38	RA863	RA18-8	RB657-200	14RB-8FX	RC1163	RC10-14F
NW23	NW22-10	RA867	18RA-8	RB713	RB14-14	RC1167	10RC-14F

Packaging cross reference

Cat. no. ABB distributor package	Cat. no. ABB bulk package	Cat. no. ABB distributor package	Cat. no. ABB bulk package
RC1223	RC10-8FS	RD717	RD8-14
RC1253	RC10-10FS	RD727	RD8-516
RC1337	10RC-6F	RD737	RD8-38
RC155PT	RC10-55PT	RD757	RD8-12
RC2203	RC10-6FL	RDD27	2RD8
RC2207	10RC-6FL	RE267	RE6-10
RC2207-250	10RC-6FLX	RE717	RE6-14
RC2213	RC10-8FL	RE727	RE6-516
RC2217	10RC-8FL	RE737	RE6-38
RC2217-250	10RC-8FLX	RE757	RE6-12
RC2223	RC10-10FL	REE28	2RE6
RC2227	10RC-10FL	RF267	RF4-10
RC2227-250	10RC-10FLX	RF717	RF4-14
RC2233	RC10-14FL	RF727	RF4-516
RC2237	10RC-14FL	RF737	RF4-38
RC250	RC10-250F	RF757	RF4-12
RC2517	10RC-250T	RG267	RG2-10
RC25177	10RC-251T	RG717	RG2-14
RC257	10RC-250F	RG727	RG2-516
RC2573	10RC-2577	RG737	RG2-38
RC2577F	RC10-250A	RG757	RG2-12
RC333	RC10-6	RP7	RP12
RC337	10RC-6		
RC337-250	10RC-6X		
RC363	RC10-10		
RC364	RC10-10X		
RC367	10RC-10		
RC367-250	10RC-10X		
RC55PT	10RC-55PT		
RC6	RC55		
RC703	RC10-516		
RC707	10RC-516		
RC713	RC10-14		
RC714	RC10-14X		
RC717	10RC-14		
RC717-250	10RC-14X		
RC733	RC10-38		
RC734	RC10-38X		
RC737	10RC-38		
RC737-250	10RC-38X		
RC753	RC10-12		
RC777	10RC-8		
RC777-250	10RC-8X		
RC863	RC10-8		
RC864	RC10-8X		
RCC21	2RC10		
RCC217-250	2RC10X		
RCC23	2RCC		
RCC26	2C-12		
RD367	RD8-10		

Catamount terminals



Catamount terminals – now in convenient, spillproof, re-usable packaging.

While poly bags keep their contents dry, they don't offer much other protection, and they aren't environmentally friendly. That's why Catamount terminals now come in sturdy plastic containers that safeguard the connectors inside against crushing and can be re-used or recycled when empty. ABB is always adding value to its products. With the introduction of a durable plastic container, the value of ABB's Catamount terminals has been significantly enhanced. No more lost or spilled terminals because of inadequate packaging.



Vinyl-insulated ring terminals



Cat. no.	Wire range (AWG)	Bolt hole (in.)	Pkg. qty.
TV18-6R-XV	22-16	#6	15
TV18-8R-XV	22-16	#8	15
TV18-10R-XV	22-16	#10	15
TV14-6R-XV	16-14	#6	15
TV14-8R-XV	16-14	#8	15
TV14-10R-XV	16-14	#10	15
TV10-8R-XV	12-10	#8	15
TV10-10R-XV	12-10	#10	15
TV10-14R-XV	12-10	¼	15



Vinyl-insulated fork terminals



Cat. no.	Wire range (AWG)	Bolt hole (in.)	Pkg. qty.
TV18-6F-XV	22-16	#6	15
TV18-8F-XV	22-16	#8	15
TV14-6F-XV	16-14	#6	15
TV14-8F-XV	16-14	#8	15
TV14-10F-XV	16-14	#10	15
TV10-8F-XV	12-10	#8	15
TV10-10F-XV	12-10	#10	15
TV10-14F-XV	12-10	¼	15



Vinyl-insulated butt splices



Cat. no.	Wire range (AWG)	Pkg. qty.
TV18-BS-XV	22-16	15
TV14-BS-XV	16-14	15
TV10-BS-XV	12-10	15

Vinyl-insulated butt splices kit



Cat. no.	Wire range (AWG)	Qty	Pkg. qty.
TV10-18-BS	22-18	5	15
	16-14	5	15
	12-10	5	15



Nylon-insulated wire joints



Cat. no.	Wire range (AWG)	Pkg. qty.
TN18-WJ-XV	22-18	15
TN14-WJ-XV	16-14	15
TN10-WJ-XV	12-10	15



Vinyl-insulated female disconnects – 250 series



Cat. no.	Wire range (AWG)	Pkg. qty.
TV18-250FD-XV	22-16	15
TV14-250FD-XV	16-14	15
TV10-250FD-XV	12-10	15



Vinyl-insulated male disconnects – 250 series



Cat. no.	Wire range (AWG)	Pkg. qty.
TV18-250MD-XV	22-16	15
TV14-250MD-XV	16-14	15
TV10-250MD-XV	12-10	15



Vinyl-insulated pin terminal



Cat. no.	Wire range (AWG)	Pkg. qty.
TV18-12PT-XV	22-16	15
TV14-12PT-XV	16-14	15
TV10-14PT-XV	12-10	15



Vinyl-insulated blade terminal



Cat. no.	Wire range (AWG)	Pkg. qty.
TV18-10BL-XV	22-16	15
TV14-10BL-XV	16-14	15
TV14-18BL-XV	16-14	15
TV10-10BL-XV	12-10	15

Catamount terminals



Vinyl-insulated double crimp locking fork 

Cat. no.	Wire range (AWG)	Pkg. qty.
TV18-10LFD-XV	22-16	15
TV18-6LFD-XV	22-16	15
TV18-8LFD-XV	22-16	15
TV14-10LFD-XV	16-14	15
TV14-6LFD-XV	16-14	15
TV14-8LFD-XV	16-14	15
TV10-10LFD-XV	12-10	15
TV10-6LFD-XV	12-10	15
TV10-8LFD-XV	12-10	15



Vinyl-insulated locking fork terminal 

Cat. no.	Wire range (AWG)	Pkg. qty.
TV18-10LF-XV	22-16	15
TV18-6LF-XV	22-16	15
TV18-8LF-XV	22-16	15
TV14-10LF-XV	16-14	15
TV14-6LF-XV	16-14	15
TV14-8LF-XV	16-14	15
TV10-10LF-XV	12-10	15
TV10-6LF-XV	12-10	15
TV10-8LF-XV	12-10	15



Non-insulated ring terminals 

Cat. no.	Wire range (AWG)	Pkg. qty.
T14-10R-XV	16-14	15
T14-8R-XV	16-14	15
T10-10R-XV	12-10	15
T10-14R-XV	12-10	15
T10-8R-XV	12-10	15



Non-insulated fork terminals 

Cat. no.	Wire range (AWG)	Pkg. qty.
T18-10F-XV	22-18	15
T18-8F-XV	22-18	15
T14-10F-XV	16-14	15
T14-8F-XV	16-14	15
T10-10F-XV	12-10	15
T10-14F-XV	12-10	15
T10-8F-XV	12-10	15



Vinyl fully insulated double crimp female disconnect 

Cat. no.	Wire range (AWG)	Pkg. qty.
TVF18-250FDD-XV	22-16	15
TVF14-250FDD-XV	16-14	15
TVF10-250FDD-XV	12-10	15



Vinyl fully insulated female disconnect 

Cat. no.	Wire range (AWG)	Pkg. qty.
TVF18-250FD-XV	22-16	15
TVF14-250FD-XV	16-14	15
TVF10-250FD-XV	12-10	15



Vinyl-insulated double crimp piggy-back disconnect 

Cat. no.	Wire range (AWG)	Pkg. qty.
TV18-250PDD-XV	22-16	15
TV14-250PDD-XV	16-14	15
TV10-250PDD-XV	12-10	15



Vinyl-insulated piggy-back disconnect 

Cat. no.	Wire Range (AWG)	Pkg. qty.
TV18-250PD-XV	22-16	15
TV14-250PD-XV	16-14	15
TV10-250PD-XV	12-10	15



Vinyl-insulated quick splice 

Cat. no.	Wire range (AWG)	Pkg. qty.
TV18-00QS-V	22-18	15
TV14-00QS-V	18-14	15
TV10-00QS-V	12-10	15



Vinyl-insulated double crimp female disconnect 

Cat. no.	Wire range (AWG)	Pkg. qty.
TV18-250FDD-XV	22-16	15
TV14-250FDD-XV	16-14	15
TV10-250FDD-XV	12-10	15

Catamount terminals



Nylon fully insulated female disconnect



Cat. no.	Wire range (AWG)	Pkg. qty.
TNF18-250FD-XV	22-16	15
TNF14-250FD-XV	16-14	15
TNF10-250FD-XV	12-10	15



Nylon fully insulated male disconnect



Cat. no.	Wire range (AWG)	Pkg. qty.
TNF-18-250MD-XV	22-16	15
TNF-14-250MD-XV	16-14	15
TNF-10-250MD-XV	12-10	15



Nylon fully insulated female bullet



Cat. no.	Wire range (AWG)	Pkg. qty.
TNF18-4FB-XV	22-16	15
TNF14-4FB-XV	16-14	15



Nylon fully insulated male bullet



Cat. no.	Wire range (AWG)	Pkg. qty.
TNF18-4MB-XV	22-16	15
TNF14-4MB-XV	16-14	15



Nylon fully insulated double crimp female disconnects



Cat. no.	Wire range (AWG)	Pkg. qty.
TNF-18-250FDD-XV	22-16	15
TNF-14-250FDD-XV	16-14	15
TNF-10-250FDD-XV	12-10	15



Nylon fully insulated double crimp male disconnect



Cat. no.	Wire range (AWG)	Pkg. qty.
TNF-18-250MDD-XV	22-16	15
TNF-14-250MDD-XV	16-14	15
TNF-10-250MDD-XV	12-10	15



Vinyl-insulated double crimp male disconnect



Cat. no.	Wire range (AWG)	Pkg. qty.
TV-18-250MDD-XV	22-16	15
TV-14-250MDD-XV	16-14	15
TV-10-250MDD-XV	12-10	15

Catamount terminal tools

- 01 WT111M
- 02 WT112M
- 03 ERG1-WS
- 04 CM2000A
- 05 TBM6S



— 01



— 04



— 02



— 05



— 03

Cat. no.	Description	Pkg. qty.
WT111M	Plier tool with cutter for 22-10 AWG non-insulated terminals	1
WT112M	Pier tool with cutter for 22-10 AWG insulated and non-insulated terminals, splices and disconnects	1
TBM6S	Toggle-type hand tool with Shure-Stake for 8-6 AWG, vinyl-insulated terminals (dies sold separately)	1
ERG1-WS	Ergonomic wire stripping tool	1
CM2000A	10 in. ratchet crimping tool for insulated terminals (22-10 AWG)	1

Polycarbonate-insulated ring terminals



Technical information

Material	Electrolytic copper
Plating	Tin-plated
Marking	Wire size and bolt size stamped on the tongue
Metal barrel	Brazed seam to prevent barrel separation
Insulation	PC = Polycarbonate
Temperature resistance	115 °C / 125 °C
Colour coding of the insulation	According to the wire size
Cable insertion	Easy entry

Cat. no.	Wire size range (mm ²)	Colour	Stud hole size d2	Dimensions (mm)				Wt. (g/100)	Qty. (pieces)	Crimping tool
				W	L	D	L1			
RZ3	0.25–0.75	Green	M3	5.5	18.0	3.2	15.0	36	100	ERG2510
RZ4	0.25–0.75		M4	7.5	21.0	3.2	17.5	45	100	ERG2510
RZ5	0.25–0.75		M5	9.0	22.0	3.2	17.5	51	100	ERG2510
RA3RR	0.5–1.5	Red	M3	5.5	19.0	4.0	16.0	60	100	ERG2001A, WT2124Y
RA4RR	0.5–1.5		M4	7.0	20.5	4.0	17.0	71	100	ERG2001A, WT2124Y
RA5RR	0.5–1.5		M5	9.0	22.5	4.0	18.0	79	100	ERG2001A, WT2124Y
RA6RR	0.5–1.5		M6	11.0	26.5	4.0	21.0	96	100	ERG2001A, WT2124Y
RB3	1.5–2.5	Blue	M3	5.5	19.0	4.5	16.0	75	100	ERG2001A, WT2124Y
RB4-EU	1.5–2.5		M4	7.0	20.5	4.5	17.0	92	100	ERG2001A, WT2124Y
RB5	1.5–2.5		M5	9.0	22.5	4.5	18.0	96	100	ERG2001A, WT2124Y
RB6	1.5–2.5		M6	11.0	26.5	4.5	21.0	117	100	ERG2001A, WT2124Y
RB8	1.5–2.5		M8	14.0	27.5	4.5	21.0	141	100	ERG2001A, WT2124Y
RC4	4.0–6.0	Yellow	M4	8.0	24.0	6.4	20.5	158	100	ERG2001A, WT2124Y
RC5	4.0–6.0		M5	9.0	25.0	6.4	20.5	166	100	ERG2001A, WT2124Y
RC6-EU	4.0–6.0		M6	11.0	28.5	6.4	23.0	179	100	ERG2001A, WT2124Y
RC8	4.0–6.0		M8	14.0	31.0	6.4	24.0	220	100	ERG2001A, WT2124Y
RC10E	4.0–6.0		M10	17.0	34.0	6.4	25.5	245	100	ERG2001A, WT2124Y

Diagram

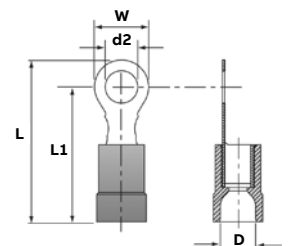

Polycarbonate-insulated fork terminals



Technical information

Material	Electrolytic copper
Plating	Tin-plated
Marking	Wire size and bolt size stamped on the tongue
Metal barrel	Brazed seam to prevent barrel separation
Insulation	PC = Polycarbonate
Temperature resistance	115 °C / 125 °C
Colour coding of the insulation	According to the wire size
Cable insertion	Easy entry

Cat. no.	Wire size range (mm ²)	Colour	Stud hole size d2	Dimensions (mm)				Wt. (g/100)	Qty. (pieces)	Crimping tool
				W	L	D	L1			
RZ3F	0.25–0.75	Green	M3	5.5	18.0	3.2	15.0	41	100	ERG2510
RZ4F	0.25–0.75	Green	M4	7.5	21.0	3.2	17.5	41	100	ERG2510
RA35F	0.5–1.5	Red	M3.5	5.5	21.0	4.0	17.5	62	100	ERG2001A, WT2124Y
RA4F	0.5–1.5		M4	7.0	20.5	4.0	17.0	64	100	ERG2001A, WT2124Y
RA5F	0.5–1.5		M5	9.0	22.5	4.0	18.0	75	100	ERG2001A, WT2124Y
RA6F	0.5–1.5		M6	11.0	26.5	4.0	21.0	90	100	ERG2001A, WT2124Y
RB3F	1.5–2.5	Blue	M3	5.5	19.0	4.5	16.0	72	100	ERG2001A, WT2124Y
RB4F	1.5–2.5		M4	7.0	20.5	4.5	17.0	84	100	ERG2001A, WT2124Y
RB5F	1.5–2.5		M5	9.0	22.5	4.5	18.0	96	100	ERG2001A, WT2124Y
RB6F	1.5–2.5		M6	11.0	26.5	4.5	21.0	113	100	ERG2001A, WT2124Y
RC4F	4.0–6.0	Yellow	M4	8.0	24.0	6.4	20.5	159	100	ERG2001A, WT2124Y
RC5F	4.0–6.0		M5	9.0	25.0	6.4	20.5	161	100	ERG2001A, WT2124Y
RC6F	4.0–6.0		M6	11.0	28.5	6.4	23.0	174	100	ERG2001A, WT2124Y
RC8F	4.0–6.0		M8	14.0	31.0	6.4	24.0	207	100	ERG2001A, WT2124Y
RC10F	4.0–6.0		M10	18.0	36.0	6.4	27.0	280	100	ERG2001A, WT2124Y

Diagram

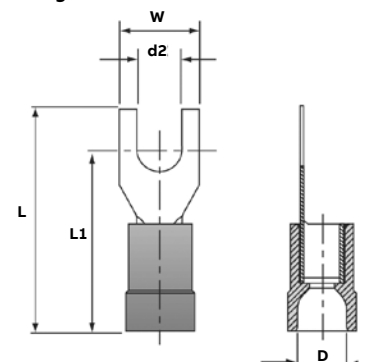

Vinyl-insulated ring terminals DIN 46237



Technical information

Material	Copper
Plating	Tin-plated
Marking	Wire size and bolt size stamped on the tongue
Metal barrel	Brazed seam to prevent barrel separation
Insulation	PVC = Polyvinylchloride (vinyl) Ideal for harsh environments, provides excellent chemical, impact and abrasion resistance
Max. electrical rating	75 °C 600 Volts max.
Colour coding of the insulation	According to the wire size

Cat. no.	Wire size range (mm ²)	Colour	Stud hole size d2	Dimensions (mm)			Wt. (g/100)	Qty. (pieces)	Crimping tool
				W	L1	D			
VB-3RR	0.5–1.5	Red	M3	6.0	17.2	4.0	68	100	ERG2001A, WT2124Y
VB-35RR	0.5–1.5		M3.5	6.0	17.2	4.0	69	100	ERG2001A, WT2124Y
VB-4RR	0.5–1.5		M4	8.0	18.2	4.0	73	100	ERG2001A, WT2124Y
VB-5RR	0.5–1.5		M5	10.0	19.2	4.0	92	100	ERG2001A, WT2124Y
VB-6RR	0.5–1.5		M6	10.0	19.2	4.0	87	100	ERG2001A, WT2124Y
VB-8RR	0.5–1.5		M8	14.0	23.2	4.0	139	100	ERG2001A, WT2124Y
VB-10RR	0.5–1.5		M10	14.0	23.2	4.0	100	100	ERG2001A, WT2124Y
VB-3BR	1.5–2.5	Blue	M3	6.0	17.5	4.5	80	100	ERG2001A, WT2124Y
VB-35BR	1.5–2.5		M3.5	6.0	17.5	4.5	94	100	ERG2001A, WT2124Y
VB-4BR	1.5–2.5		M4	8.0	18.5	4.5	83	100	ERG2001A, WT2124Y
VB-5BR	1.5–2.5		M5	10.0	20.5	4.5	110	100	ERG2001A, WT2124Y
VB-6BR	1.5–2.5		M6	11.0	22.5	4.5	122	100	ERG2001A, WT2124Y
VB-8BR	1.5–2.5		M8	14.0	23.5	4.5	146	100	ERG2001A, WT2124Y
VB-10BR	1.5–2.5		M10	15.0	23.5	4.5	204	100	ERG2001A, WT2124Y
VB-4YR	4.0–6.0	Yellow	M4	8.0	22.1	6.3	167	100	ERG2001A, WT2124Y
VB-5YR	4.0–6.0		M5	10.0	23.1	6.3	196	100	ERG2001A, WT2124Y
VB-6YR	4.0–6.0		M6	11.0	24.1	6.3	195	100	ERG2001A, WT2124Y
VB-8YR	4.0–6.0		M8	14.0	27.1	6.3	250	100	ERG2001A, WT2124Y
VB-10YR	4.0–6.0		M10	18.0	29.1	6.3	305	100	ERG2001A, WT2124Y

Diagram

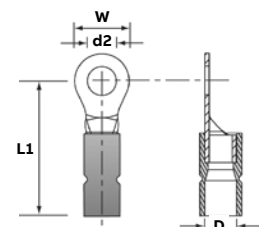

Nylon-insulated ring terminals DIN 46237



Technical information

Material	Copper
Plating	Tin-plated
Marking	Wire size and bolt size stamped on the tongue
Metal barrel	Brazed seam to prevent barrel separation
Insulation	PA = Polyamide Ideal for harsh environments, provides excellent chemical, impact and abrasion resistance
Temperature resistance	85 °C / 105 °C
Colour coding of the insulation	According to the wire size

Cat. no.	Wire size range (mm ²)	Colour	Stud hole size d2	Dimensions (mm)			Wt. (g/100)	Qty. (pieces)	Crimping tool
				W	L1	D			
TRA3	0.5–1.5	Red	M3	5.5	17.5	4.0	70	100	ERG2001A, WT2124Y
TRA35	0.5–1.5		M3.5	6.6	20.4	4.0	67	100	ERG2001A, WT2124Y
TRA4	0.5–1.5		M4	8.0	21.8	4.0	76	100	ERG2001A, WT2124Y
TRA5	0.5–1.5		M5	8.0	21.8	4.0	79	100	ERG2001A, WT2124Y
TRA6	0.5–1.5		M6	11.6	27.5	4.0	108	100	ERG2001A, WT2124Y
TRA8	0.5–1.5		M8	11.6	27.5	4.0	134	100	ERG2001A, WT2124Y
TRB3	1.5–2.5	Blue	M3	6.0	20.6	4.5	79	100	ERG2001A, WT2124Y
TRB35	1.5–2.5		M3.5	8.5	23.0	4.5	76	100	ERG2001A, WT2124Y
TRB4	1.5–2.5		M4	8.5	23.0	4.5	79	100	ERG2001A, WT2124Y
TRB5	1.5–2.5		M5	9.5	22.9	4.5	89	100	ERG2001A, WT2124Y
TRB6	1.5–2.5		M6	12.0	28.0	4.5	117	100	ERG2001A, WT2124Y
TRB8	1.5–2.5		M8	12.0	28.0	4.5	148	100	ERG2001A, WT2124Y
TRB10	1.5–2.5	M10	13.6	31.7	4.5	204	100	ERG2001A, WT2124Y	
TRC4-EU	4.0–6.0	Yellow	M4	7.4	26.7	6.4	158	100	ERG2001A, WT2124Y
TRC5-EU	4.0–6.0		M5	9.5	26.7	6.4	175	100	ERG2001A, WT2124Y
TRC6-EU	4.0–6.0		M6	12.0	32.7	6.4	187	100	ERG2001A, WT2124Y
TRC8	4.0–6.0		M8	15.0	34.9	6.4	230	100	ERG2001A, WT2124Y
TRC10	4.0–6.0		M10	15.0	34.9	6.4	296	100	ERG2001A, WT2124Y

Diagram

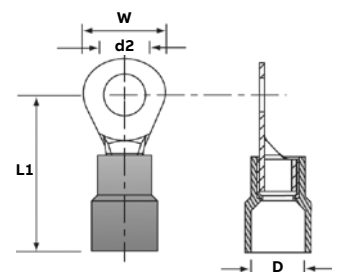

Nylon-insulated fork terminals DIN 46237



Technical information

Material	Copper
Plating	Tin-plated
Marking	Wire size and bolt size stamped on the tongue
Metal barrel	Brazed seam to prevent barrel separation
Insulation	PA = Polyamide Ideal for harsh environments, provides excellent chemical, impact and abrasion resistance
Temperature resistance	85 °C / 105 °C
Colour coding of the insulation	According to the wire size
Cable insertion	Easy entry

Cat. no.	Wire size range (mm ²)	Colour	Stud hole size d2	Dimensions (mm)			Wt. (g/100)	Qty. (pieces)	Crimping tool
				W	L1	D			
TRA3F	0.5–1.5	Red	M3	5.7	22.0	4.0	65	100	ERG2001A, WT2124Y
TRA35F	0.5–1.5		M3.5	6.2	22.0	4.0	62	100	ERG2001A, WT2124Y
TRA4F	0.5–1.5		M4	7.2	22.0	4.0	70	100	ERG2001A, WT2124Y
TRA5F	0.5–1.5		M5	8.0	22.0	4.0	92	100	ERG2001A, WT2124Y
TRA6F	0.5–1.5		M6	10.8	23.0	4.0	102	100	ERG2001A, WT2124Y
TRB3F	1.5–2.5	Blue	M3	5.7	22.2	4.5	81	100	ERG2001A, WT2124Y
TRB35F	1.5–2.5		M3.5	6.2	22.2	4.5	74	100	ERG2001A, WT2124Y
TRB4F	1.5–2.5		M4	7.2	22.2	4.5	80	100	ERG2001A, WT2124Y
TRB5F	1.5–2.5		M5	8.0	22.2	4.5	110	100	ERG2001A, WT2124Y
TRB6F	1.5–2.5		M6	10.8	23.5	4.5	122	100	ERG2001A, WT2124Y
TRC4F	4.0–6.0	Yellow	M4	8.2	26.7	6.4	163	100	ERG2001A, WT2124Y
TRC5F	4.0–6.0		M5	9.0	26.7	6.4	182	100	ERG2001A, WT2124Y
TRC6F	4.0–6.0		M6	12.0	30.3	6.4	190	100	ERG2001A, WT2124Y

Diagram

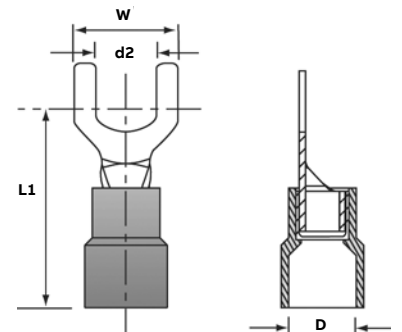

Vinyl-insulated fork terminals DIN 46237



Technical information

Material	Copper
Plating	Tin-plated
Marking	Wire size and bolt size stamped on the tongue
Metal barrel	Brazed seam to prevent barrel separation
Insulation	PVC = Polyvinylchloride (vinyl)
Max. electrical rating	75 °C 600 Volts
Colour coding of the insulation	According to the wire size
Cable insertion	Easy entry

Cat. no.	Wire size range (mm ²)	Colour	Stud hole size d2	Dimensions (mm)			Wt. (g/100)	Qty. (pieces)	Crimping Tool
				W	L1	D			
VB-4RF	0.5-1.5	Red	M4	6.8	18.2	4.0	73	100	ERG2001A
VB-5RF	0.5-1.5		M5	10.0	19.2	4.0	92	100	ERG2001A
VB-6RF	0.5-1.5		M6	11.0	21.2	4.0	103	100	ERG2001A
VB-3BF	1.5-2.5	Blue	M3	5.5	19.5	4.5	90	100	ERG2001A
VB-35BF	1.5-2.5		M3.5	6.0	17.5	4.5	97	100	ERG2001A
VB-4BF	1.5-2.5		M4	6.8	19.2	4.5	83	100	ERG2001A
VB-5BF	1.5-2.5		M5	10.0	20.5	4.5	110	100	ERG2001A
VB-6BF	1.5-2.5	M6	11.0	22.5	4.5	121	100	ERG2001A	
VB-4YF	2.5-6.0	Yellow	M4	8.0	22.1	6.3	169	100	ERG2001A
VB-5YF	2.5-6.0		M5	10.0	23.1	6.3	189	100	ERG2001A
VB-6YF	2.5-6.0		M6	11.0	24.1	6.3	200	100	ERG2001A
VB-8YF	2.5-6.0		M8	14.0	27.1	6.3	235	100	ERG2001A
VB-10YF	2.5-6.0		M10	18.0	29.1	6.3	305	100	ERG2001A

Diagram

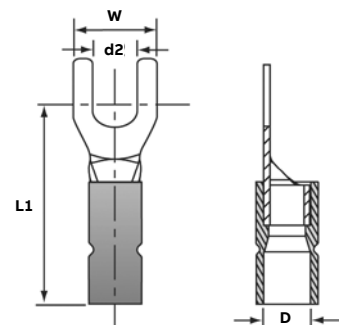

Polycarbonate-insulated pin terminals



Technical information

Material	Electrolytic copper
Plating	Tin-plated
Metal barrel	Brazed seam to prevent barrel separation
Insulation	PC = Polycarbonate
Temperature resistance	115 °C / 125 °C
Colour coding of the insulation	According to the wire size
Cable insertion	Easy entry

Cat. no.	Wire size range (mm ²)	Colour	Dimensions (mm)				Wt. (g/100)	Qty. (pieces)	Crimping tool
			L	F	B	D			
RZP	0.25–0.75	Green	22.0	12.0	1.8	3.2	47	100	ERG2510
RAP	0.5–1.5	Red	22.0	12.0	1.9	4.0	67	100	ERG2001A, WT2124Y
RBP	1.5–2.5	Blue	22.0	12.0	1.9	4.5	80	100	ERG2001A, WT2124Y
RCP	4.0–6.0	Yellow	27.0	14.0	2.8	6.4	175	100	ERG2001A, WT2124Y

Diagram

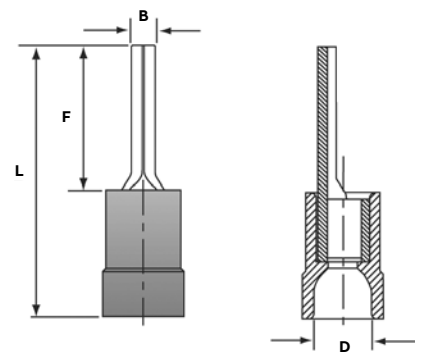

Insulated female disconnects DIN 46245



Technical information

Material	Brass
Plating	Tin-plated
Metal barrel	Brazed seam to prevent barrel separation
Insulation	PC = Polycarbonate
Temperature resistance	115 °C / 125 °C (for PVC insulation 65 °C / 75 °C)
Colour coding of the insulation	According to the wire size (DIN)
Cable insertion	Easy entry

Cat. no.	Wire size range (mm ²)	Male tab size (mm)	Colour	Dimensions (mm)			Wt. (g/100)	Qty. (pieces)	Crimping tool
				L	D	W			
RA28	0.5–1.5	2.8 x 0.8	Red	18.5	3.3	3.5	60	100	ERG2001A, WT2124Y
RA29	0.5–1.5	2.8 x 0.5		18.5	3.3	3.5	60	100	ERG2001A, WT2124Y
RA48**	0.5–1.5	4.8 x 0.8		19.0	3.7	5.7	82	100	ERG2001A, WT2124Y
RA49**	0.5–1.5	4.8 x 0.5		19.0	3.7	5.7	83	100	ERG2001A, WT2124Y
RA63	0.5–1.5	6.3 x 0.8		20.0	4.0	7.6	96	100	ERG2001A, WT2124Y
RB48**	1.5–2.5	4.8 x 0.5	Blue	19.0	4.4	5.7	91	100	ERG2001A, WT2124Y
RB49**	1.5–2.5	4.8 x 0.8		19.0	4.4	5.7	87	100	ERG2001A, WT2124Y
RB63	1.5–2.5	6.3 x 0.8		20.0	4.5	7.6	106	100	ERG2001A, WT2124Y
RC63	4.0–6.0	6.3 x 0.8	Yellow	24.0	6.4	7.6	183	100	ERG2001A, WT2124Y
RC95**	4.0–6.0	9.5 x 1.2		31.0	6.2	11.0	233	100	ERG2001A, WT2124Y

**Non-brazed, with support sleeve and PVC insulation, not easy entry

Diagram

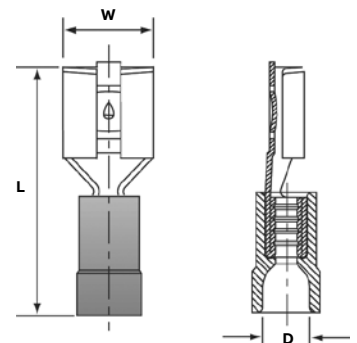

Insulated male disconnects DIN 46245



Technical information

Material	Brass
Plating	Tin-plated
Metal barrel	Brazed seam to prevent barrel separation
Insulation	PC = Polycarbonate
Temperature resistance	115 °C / 125 °C (for PVC insulation 65 °C / 75 °C)
Colour coding of the insulation	According to the wire size (DIN)
Cable insertion	Easy entry

Cat. no.	Wire size range (mm ²)	Male tab size (mm)	Colour	Dimensions (mm)		Wt. (g/100)	Qty. (pieces)	Crimping tool
				L	D			
RA63M	0.5–1.5	6.3 x 0.8	Red	22.0	4.0	107	100	ERG2001A, WT2124Y
RB63M	1.5–2.5	6.3 x 0.8	Blue	22.0	4.5	107	100	ERG2001A, WT2124Y
RC63M**	4.0–6.0	6.3 x 0.8	Yellow	25.0	6.3	155	100	ERG2001A, WT2124Y

**PVC insulation. No easy entry and non-brazed, with brass support sleeve

Diagram

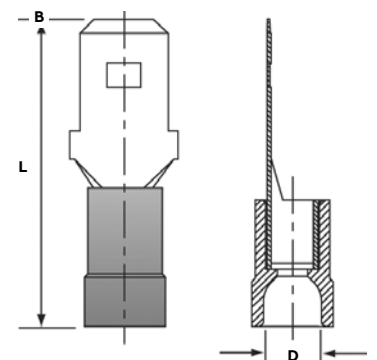

Fully insulated female disconnects DIN 46245



Technical information

Material	Brass
Plating	Tin-plated
Metal barrel	Non-brazed, with brass support sleeve
Insulation	PA = Polyamide Ideal for harsh environments, provides excellent chemical, impact and abrasion resistance
Temperature resistance	85 °C / 105 °C
Colour coding of the insulation	According to the wire size (DIN)

Cat. no.	Wire size range (mm ²)	Male tab size (mm)	Colour	Dimensions (mm)			Wt. (g/100)	Qty. (pieces)	Crimping tool
				W	L	D			
RA28V	0.5–1.5	2.8 x 0.8	Red	5.0	19.3	3.8	110	100	ERG2001A, WT2124Y
RA29V	0.5–1.5	2.8 x 0.5		5.0	19.3	3.8	110	100	ERG2001A, WT2124Y
RA48V	0.5–1.5	4.8 x 0.8		7.4	20.2	3.6	115	100	ERG2001A, WT2124Y
RA49V	0.5–1.5	4.8 x 0.5		7.4	20.2	3.6	115	100	ERG2001A, WT2124Y
RA63V**	0.5–1.5	6.3 x 0.8		8.8	21.0	4.0	123	100	ERG2001A, WT2124Y
RB48V	1.5–2.5	4.8 x 0.8	Blue	7.1	19.5	3.9	120	100	ERG2001A, WT2124Y
RB49V	1.5–2.5	4.8 x 0.5		7.1	19.5	3.9	120	100	ERG2001A, WT2124Y
RB63V**	1.5–2.5	6.3 x 0.8		8.8	21.0	4.5	132	100	ERG2001A, WT2124Y
RC63V	4.0–6.0	6.3 x 0.8	Yellow	9.0	26.0	5.3	215	100	ERG2001A, WT2124Y

**Easy entry and brazed barrel, polycarbonate insulator

Diagram

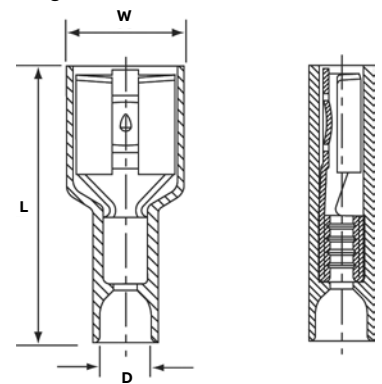

Fully insulated butt splices



Technical information

Material	Electrolytic copper
Plating	Tin-plated
Metal barrel	Brazed seam to prevent barrel separation
Insulation	PC = Polycarbonate
Temperature resistance	115 °C / 125 °C
Colour coding of the insulation	According to the wire size (DIN)
Cable insertion	Easy entry

Cat. no.	Wire size range (mm ²)	Colour	Dimensions (mm)		Wt. (g/100)	Qty. (pieces)	Crimping tool
			L	D			
RAA15	0.5–1.5	Red	24.0	3.4	97	100	ERG2001A, WT2124Y
RBB25	1.5–2.5	Blue	26.0	4.3	150	100	ERG2001A, WT2124Y
RCC6	4.0–6.0	Yellow	33.0	6.5	316	100	ERG2001A, WT2124Y

Diagram

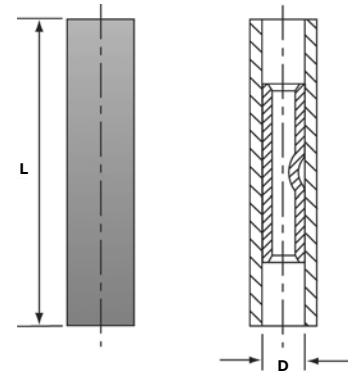

Insulated wire joints



Technical information

Material	Brass
Plating	Tin-plated
Metal barrel	Brazed seam to prevent barrel separation
Insulation	PA = Polyamide Ideal for harsh environments, provides excellent chemical, impact and abrasion resistance
Temperature resistance	85 °C / 105 °C

Cat. no.	Wire size range (mm ²)	Colour	Dimensions (mm)			Wt. (g/100)	Qty. (pieces)	Crimping tool
			F	L	D			
RBJ	1.0–3.0	White	8.0	15.2	6.4	86	100	ERG2001A, WT2124Y
RCJ	2.0–6.0		9.0	17.7	9.2	166	100	ERG2001A, WT2124Y

Diagram

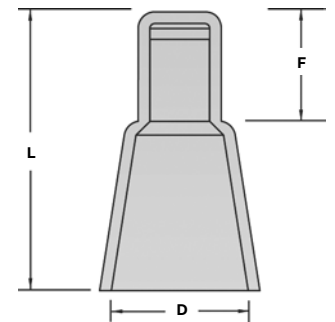

Tools

- Ergonomic ratchet-style hand tools used for installing insulated and non-insulated terminals
- Specially designed ergonomic handles distribute the crimping force more evenly across the user's hands, helping to reduce the risk of carpal tunnel syndrome, the cause of almost one in two industrial injuries
- Ratchet design greatly reduces handle forces over conventional hand tools and incorporates the Shure-Stake mechanism, which ensures a full crimp cycle every time
- Most dies incorporate wire range marking for easy inspection (insulated only)
- Colour-coded die nests (insulated only) make terminal and die nest selection easy
- The product design and engineering results in a long lasting precision tool
- Exists in 2 versions: with interchangeable dies or with fixed dies

Toggle action increases mechanical gain, which dramatically reduces handle force – and the stress on your hands

For easy visual verification of crimps, integrity dots are embossed on the top and bottom of the terminal

Colour-coded die nests on both the right and left sides of the tool are included for insulated terminals

Advanced ergonomic design of handle distributes the force more evenly across the hand

Rubberized thermoplastic handle combines maximum friction with a soft, comfortable feel that reduces muscle tension

Shure-Stake mechanism ensures a complete crimp cycle before it releases

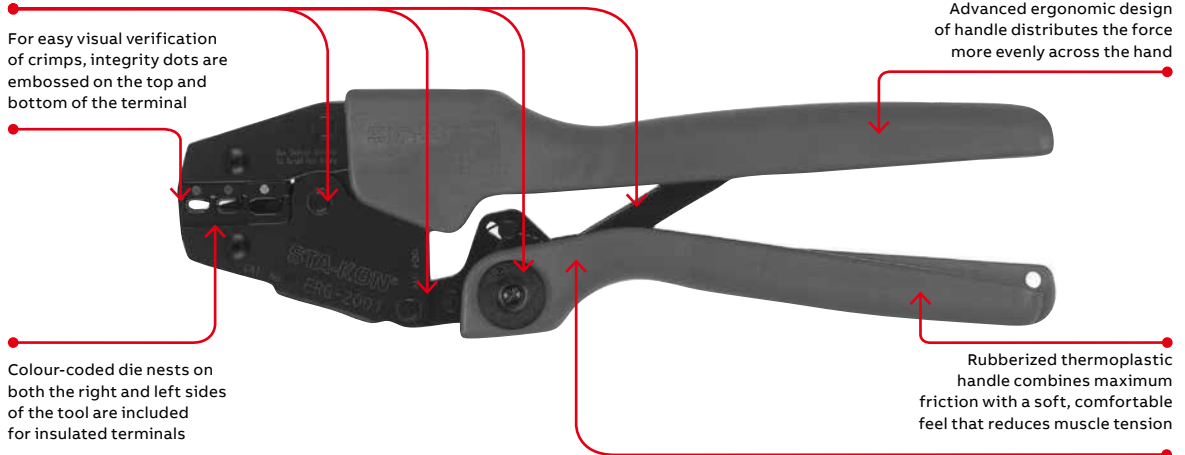

— 01 ERG2001A

— 02 ERG2510

Product ref.: ERG2001A

Ergonomic fixed die tool, with three colour-coded die nests for easy selection.

For insulated terminals from:

- 0.5 to 1.5 mm² red
- 1.5 to 2.5 mm² blue
- 4.0 to 6.0 mm² yellow

Shure-Stake mechanism

Length: 255 mm

Weight: 560 g



— 01

Product ref.: ERG2510

Ergonomic fixed die tool with 2 die nests.

For insulated terminals and insulated bootlace ferrules from:

- 0.25 to 0.5 mm²
- 0.5 to 1.0 mm²

Shure-Stake mechanism

Length: 220 mm

Weight: 430 g



— 02

Tools

Metric crimping tools

An extensive range of tooling is available, suiting a variety of requirements, to crimp the following terminals:

- Insulated terminals and bootlace ferrules
- Non-insulated terminals
- Copper tube terminals

Different types of tooling are offered, depending on volume and application:

- Plier-type hand tools for occasional applications (“do-it-yourself” users)
- Standard hand tooling for low to medium volume applications
- Ergonomic hand tooling for low to medium volume applications, where high, repeatable quality is essential
- Hydraulic tooling for heavy-duty applications
- Smart tools where no die change is necessary

—
01 WT52

—
02 WT2124Y

Product ref.: WT52

Plier-type tool.

For insulated and non-insulated terminals from 0.5 to 6.0 mm².

Incorporates wire stripper and bolt cutters. Recommended for “do-it-yourself” applications only.

Length: 225 mm

Weight: 200 g

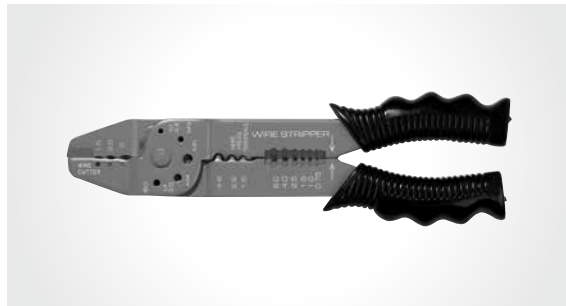

—
01

Product ref.: WT2124Y

Ratchet-type hand tool, fixed die.

For insulated and non-insulated terminals from:

- 0.5 to 1.5 mm² red
- 1.5 to 2.5 mm² blue
- 4.0 to 6.0 mm² yellow

Built in Shure-Stake mechanism to ensure a full compression every time.

Length: 228 mm

Weight: 533 g

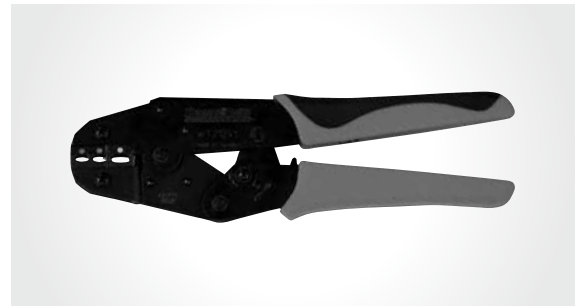

—
02



C

Shrink-Kon® - Heat-shrinkable tubing



—
C

Shrink-Kon - Heat-shrinkable tubing

Table of contents

Section C

Overview	C4
Heavy-wall heat-shrinkable tubing	C6
Medium-wall heat-shrinkable tubing	C12
Thin-wall heat-shrinkable tubing	C13
Splice insulators and insulating covers	C19
Installation tools	C25
Installation guidelines and cross reference	C26
Breakaway connector kits	C28

Overview



Protect against moisture, corrosion and abrasion. ABB has you covered when it comes to insulation.

- Easy to use
- Heat shrinkable
- Products with heavy, medium and thin walls
- Covers available for H-type taps and splices

Heavy-wall Shrink-Kon – heat-shrinkable insulators

When it comes to moisture-proofing connections and terminations, ABB's heat-shrinkable tubing, boots and end caps have proven themselves over years of service to the industry. Made of thermally stabilized cross-linked polyolefin, these heat-shrinkable insulators can be used over lead, steel, aluminum, copper, standard plastic and elastomeric insulating materials.

ABB heat-shrinkable insulators are designed to be easy to use. They provide an appropriate level of insulation and abrasion protection.

Where applicable, ABB heat-shrink insulators are UL Listed. Also, all standard size insulators have an internally applied adhesive sealant.

Heavy-wall Shrink-Kon Heat-shrinkable end cap and boots

Redesigned for superior durability and performance.

Seals and insulates cable ends at a 600 V rating. Installs fast, while providing insulation resistance to moisture, corrosion and abrasion. The extra thickness at the tip of the end cap prevents sharp ends of the cable from puncturing the seal.

Seals and insulates multiconductor cables and conduit with the same cost savings and superior properties of ABB's heat-shrinkable tubing. These boots replace time-consuming tapes, epoxies, encapsulations and dips. The boots are internally coated with sealant.

ABB heat-shrinkable insulators offer:

- Heavy-duty protection
- A full range of sizes from #14 to 2500 kcmil
- Field-proven reliability
- Internal sealant provides protection against moisture

Featured products include:

- High shrink ratio HSHR series with 6:1 shrink ratio designed for applications with extreme differences between cable, connector and back shell sizes
- Flame-retardant HSHR series provides maximum flame retardancy



Shrink-Kon – medium-wall tubing

More flexible than heavy-wall products, with excellent resistance to impact and abrasion.

- Seals and protects cable splices and terminations
- Thermoplastic adhesive liner guarantees complete environmental protection and insulation

Shrink-Kon – thin-wall tubing

Manufactured from stabilized polyolefin, these insulators are used to insulate bare Sta-Kon® and Color-Keyed® connectors and splices. They also provide a degree of strain relief and may be used to harness wires. Available in cut pieces or reels.

Featured products include:

- Standard non-lined 2:1 thin-wall tubing
- 3:1 adhesive lined thin-wall CPO-A series provides excellent flexibility with environmental sealing capability
- Extra-clear heat shrink for use on power connections and data connections

Covers

These insulating covers provide hard-shell insulated protection for “H” type compression taps and splices, and, because there is no taping required, you get uniform quality and appearance each time. The exclusive locking design provides the range-taking capability. Only six H-tap insulating catalogue numbers accommodate the range of 6 AWG–1,000 kcmil in the main and 12 AWG–500 kcmil.

- Hard-shell outer covers guard against impact... inner seal keeps out dust
- Installs quickly and easily without special tools... simply snaps together
- Eliminates time-consuming taping
- Provides high-quality, neat, uniform installations
- Range-taking design reduces inventory



Heavy-wall heat-shrinkable tubing

HS Series



3:1 Shrink ratio

- Made of thermally stabilized cross-linked polyolefin, enabling a recovered wall thickness greater than that of the cable jacket replaced
- Withstands severe mechanical requirements of U.R.D., submersible and direct burial installations
- Tubing, featuring an internally applied sealant, offers protection against moisture, and may be used over lead, steel, aluminum, copper, standard plastic and elastomeric insulating materials
- Shrink temperature of 120 °C
- High-impact, abrasion, corrosion and chemical resistance
- Rated for 600 V, 90 °C continuous use
- Thermoplastic adhesive liner provides complete environmental protection and insulation
- Meets: UL and CSA standards, ANSI C119.1, Western Underground Guide Nos. 2.4, 2.5, ICEA and NEMA insulation thickness requirements
- Continuous operating temperature: -55 °C to 110 °C
- ABB recommended up to 1 kV
- UV rated (ASTM G53)



HS Series specifications

Property	Test method	Typical performances
Physical		
Tensile strength	ASTM D412, ISO 37	2100 psi (14.5 MPa)
Elongation	ASTM D412, ISO 37	600%
Elongation after heat aging (168 hrs. at 150 °C)	ASTM D2671	500%
Heat shock (4 hrs. at 225 °C)	ASTM D2671	No cracking or flowing
Longitudinal change	ASTM D2671	+1%, -10%
Low temperature flexibility (4 hrs. at -55 °C)	ASTM D2671	No cracking
Specific gravity	ASTM D792	1.1
Hardness (Shore D)	ASTM D2240	50D
Electrical		
Dielectric strength	ASTM D149	500 V/mil (20 kV/mm)
Dielectric voltage withstand (2500 V, 600 Hz, 1 min.)	UL 486D	No breakdown, 24 kV-1 min., 15 kV-4 hrs.
Volume resistivity	ASTM D257	1016 ohm-cm
Chemical		
Fluid resistance	MIL-DTL-23053	Good to excellent
Fungus resistance	ASTM G21	No growth
Copper corrosion	ASTM D2671	No corrosion
Water absorption	ASTM D570	0.1%
Adhesive		
Adhesive lap shear (1 in./min. at 23 °C)	ASTM D1002	125 psi (0.875 MPa)
Adhesive softening point	ASTM E28	90 °C ±5 °C
Adhesive peel strength (300 mm/min. at 23 °C)		
– To steel, aluminum, P.E.	ASTM D 1000	35 linear lb/in.
– PVC	ASTM D 1000	20 linear lb/in.
Water penetration	STM 706	No penetration after 236 hrs. of continuous immersion

Heavy-wall heat-shrinkable tubing

HS Series

Heavy-wall heat-shrinkable tubing – Black



Cat. no.	Min. expanded I.D. (in.)	Max. recovered I.D. (in.)	Nom. recovered wall (in.)	Std. length (in.)	Fits any listed or certified Al or Cu splice with dia. no larger than		Cable range (AWG) or kcmil	Std. pkg. qty.
					O.D. (in.)	Length (in.)		
HS16-12	0.35	0.12	0.07	3	0.27	1.00	#14-#10	25
HS16-12L	0.35	0.12	0.07	6	0.27	1.00	#14-#10	25
HS16-12-4	0.35	0.12	0.07	48	0.27	1.00	#14-#10	5
HS12-6	0.51	0.16	0.09	3	0.38	1.75	#8-#6	25
HS12-6L	0.51	0.16	0.09	6	0.38	1.75	#8-#6	25
HS12-6-4	0.51	0.16	0.09	48	0.38	1.75	#8-#6	5
HS6-1	0.75	0.24	0.09	4	0.63	2.50	#6-#2	25
HS6-1L	0.75	0.24	0.09	8	0.63	2.50	#6-#2	25
HS6-1-4	0.75	0.24	0.09	48	0.63	2.50	#6-#2	5
HS4-30	1.10	0.35	0.12	5	0.75	3.25	#1-3/0	20
HS4-30L	1.10	0.35	0.12	9	0.75	3.25	#1-3/0	10
HS4-30-4	1.10	0.35	0.12	48	0.75	3.25	#1-3/0	5
HS40-400	1.50	0.47	0.16	8	-	-	2/0-350	10
HS40-400L	1.50	0.47	0.16	12	-	-	2/0-350	10
HS40-400-4	1.50	0.47	0.16	48	-	-	2/0-350	5
HS500-1000	2.00	0.63	0.16	9	-	-	250-500	5
HS500-1000L	2.00	0.63	0.16	15	-	-	250-500	2
HS500-1000-4	2.00	0.63	0.16	48	-	-	250-500	2
HS12-30**	3.54	1.18	0.16	12	-	-	800-1250	2
HS30-30**	3.54	1.18	0.16	30	-	-	800-1250	2
HS30-4**	3.54	1.18	0.16	48	-	-	800-1250	1
HS12-40**	4.72	1.57	0.17	12	-	-	1500-2500	1
HS30-40**	4.72	1.57	0.17	30	-	-	1500-2500	1
HS40-4-TB	4.72	1.57	0.17	48	-	-	1500-2500	1

Order multiple is std. pkg. All lengths have factory-applied sealant

**UL not applicable

Heavy-wall heat-shrinkable tubing – Red



Cat. No.	Min. expanded I.D. (in.)	Max. recovered I.D. (in.)	Length (in.)	For 2-way connector cable sizes (AWG)		Std. pkg. qty.
				For 2-way connector cable sizes (AWG)	Std. pkg. qty.	
HS12-6LR	0.51	0.16	6	#8-6	25	
HS6-1LR	0.75	0.24	8	#6-2	25	
HS4-30LR	1.10	0.35	9	#1-3/0	10	

Order multiple is std. pkg. All lengths have factory-applied sealant

Heavy-wall tubing (25 ft. rolls) – Black



Cat. No.	Min. expanded I.D. (in.)	Max. recovered I.D. (in.)	Nom. recovered wall (in.)	For 2-way connector cable sizes (AWG) or kcmil		Std. pkg. qty.
				For 2-way connector cable sizes (AWG) or kcmil	Std. pkg. qty.	
HS16-12-25	0.35	0.12	0.07	#14-10	1	
HS12-6-25	0.51	0.16	0.09	#8-6	1	
HS6-1-25	0.75	0.24	0.09	#6-#2	1	
HS4-30-25	1.10	0.35	0.12	#1-3/0	1	
HS40-400-25	1.50	0.47	0.16	2/0-350	1	
HS500-1000-25	2.00	0.63	0.16	250-500	1	

Order by reel, not by feet. 25 ft. reels not supplied with factory applied sealant

Heavy-wall heat-shrinkable tubing

HSHR Series



Heavy-wall heat-shrinkable tubing

High shrink ratio of 6:1

- Accommodates a wide variety of connector shapes and configurations
- Thermoplastic adhesive liner for complete environmental protection and insulation
- Continuous operating temperature: -55 °C to 110 °C
- Shrink temperature: 120 °C
- Flame-retardant

Cat. no.	Min. expanded I.D. (in.)	Max. recovered I.D. (in.)	Nominal recovered wall (in.)	Code cable size (AWG) or kcmil	Standard length (in.)	Std. pkg. qty.
HSHR750-4	0.75	0.13	0.10	#22-#46	48	25
HSHR1300-4	1.30	0.22	0.12	#8-700	48	25
HSHR1750-4	1.75	0.29	0.13	#4-1,000	48	25
HSHR2000-4	2.00	0.33	0.13	#2-1,250	48	25
HSHR2750-4	2.75	0.46	0.14	1/0-1,500	48	15
HSHR3500-4	3.50	0.58	0.15	3/0-1,750	48	10
HSHR4700-4	4.70	0.78	0.15	300-2,000	48	5

HSHR Series specifications

Property	Test method	Typical performances
Physical		
Tensile strength	ASTM D412, ISO 37	2,100 psi (14.5 MPa)
Elongation	ASTM D412, ISO 37	600%
Elongation after heat aging (168 hrs. at 150 °C)	ASTM D2671	500%
Heat shock (4 hrs. at 225 °C)	ASTM D2671	No cracking or flowing
Longitudinal change	ASTM D2671	+1%, -10%
Low temperature flexibility (4 hrs. at -55 °C)	ASTM D2671	No cracking
Specific gravity	ASTM D792	1.1
Hardness (Shore D)	ASTM D2240	50D
Electrical		
Dielectric strength	ASTM D149, IEC 243	500 V/mil (20 kV/mm)
Dielectric voltage withstand (2500 V, 60 Hz, 1 min.)	UL 486D	No breakdown, 15 kV-4 hrs.
Volume resistivity	ASTM D257	1,016 ohm-cm
Chemical		
Fluid resistance	MIL-DTL-23053/15	Good to excellent
Fungus resistance	ASTM G21	No growth
Copper corrosion	ASTM D2671	No corrosion
Water absorption	ASTM D570	0.1%
Adhesive		
Adhesive lap shear (1 in./min. at 23 °C)	ASTM D1002	125 psi (0.875 MPa)
Adhesive softening point	ASTM E28	90 °C ±5 °C
Adhesive peel strength (300 mm/min. at 23 °C)		
– To steel, aluminum, P.E.	ASTM D 1000	35 linear lb/in.
– PVC	ASTM D 1000	20 linear lb/in.
Adhesive blocking (30 °C)	ASTM D1146	No blocking
Water penetration	STM 706	No penetration after 236 hrs. of continuous immersion

Heavy-wall heat-shrinkable tubing

HSFR Series



3:1 Shrink ratio

Flame-retardant heavy-wall

- Insulates and protects electrical splices and terminations
- High-impact and abrasion resistance
- Thermoplastic adhesive liner
- Rated for 600 V, 90 °C continuous use
- Continuous operating temperature: -55 °C to 110 °C

- Shrink temperature of 120 °C
- Meets: UL and CSA standards, ANSI C119.1, Western Underground Guide Nos. 2.4, 2.5, MIL-DTL-23053/15, IEEE 383 vertical flame test, ANSI C37.20.2, ICEA S-19-8 and NEMA insulation thickness requirements
- UV rated (ASTM G53)

Heavy-wall heat-shrinkable tubing – Flame-retardant

	Cat. no.	Min. expanded I.D. (in.)	Max. recovered I.D. (in.)	Nominal recovered wall (in.)	Code cable size (AWG) or kcmil	Standard length (in.)	Std. pkg. qty.
	HSFR16-12-4	0.35	0.12	0.07	#14-#10	48	25
	HSFR12-6-4	0.51	0.16	0.09	#8-#6	48	25
	HSFR6-1-4	0.75	0.24	0.09	#6-#2	48	25
	HSFR4-30-4	1.10	0.35	0.12	#1-3/0	48	25
	HSFR40-400-4	1.50	0.47	0.16	2/0-350	48	25
	HSFR500-1000-4	2.00	0.63	0.16	250-500	48	25

Order multiple is std. pkg. – Standard colour: black

HSFR Series specifications

Property	Test method	Typical performances
Physical		
Tensile strength	ASTM D412, ISO 37	2,100 psi (14.5 MPa)
Elongation	ASTM D412, ISO 37	600%
Longitudinal change	ASTM D2671	+1%, -10%
Specific gravity	ASTM D792	1.2
Elongation after heat aging (168 hrs. at 175 °C)	ASTM D2671, ISO 37	500%
Heat shock (4 hrs. at 225 °C)	ASTM D2671	No cracking or flowing
Low temperature flexibility (4 hrs. at -55 °C)	ASTM D2671	No cracking or splitting
Hardness (Shore D)	ASTM D2240	50D
Oxygen index	ASTM D2863	27.00
Flammability	ASTM D2671	Flame-retardant
Electrical		
Dielectric strength	ASTM D149	500 V/mil (20 kV/mm)
Dielectric voltage withstand (2500 V, 60 Hz, 1 min.)	UL 486D	No breakdown, 24 kV-4hrs, 15 kV-4 hrs.
Volume resistivity	ASTM D257	1,016 ohm-cm
Chemical		
Fluid resistance	MIL-DTL-23053/5	Good to excellent
Fungus resistance	ASTM G21	No growth
Copper corrosion	ASTM D2671	No corrosion
Water absorption	ASTM D570	0.2%
Adhesive		
Adhesive lap shear (1 in./min. at 23 °C)	ASTM D1002	125 psi (0.875 MPa)
Adhesive softening point	ASTM E28	90 °C ±5 °C
Adhesive peel strength (300 mm/min. at 23 °C)		
– To steel, aluminum, P.E.	ASTM D 1000	35 linear lb/in.
– PVC	ASTM D 1000	20 linear lb/in.
Adhesive blocking (30 °C)	ASTM D1146	No blocking
Adhesive water absorption	ASTM D570	Less than 0.3%
Water penetration	STM 706	No penetration after 286 hrs. of continuous immersion

Heavy-wall heat-shrinkable tubing

HSC Series – Heat-shrinkable end caps



3:1 Shrink ratio

- Provides effective method for sealing cable ends, pipe conduit, etc.
- Extra thickness at the tip of the end cap prevents sharp ends of the cable from puncturing the seal
- Flame-retardant
- Rated from 600/1,000 V, 90 °C continuous use
- Shrink temperature of 120 °C
- Resistant to common fluids and solvents
- Adhesive liner provides complete environmental protection and insulation
- Heat indicating lines; continuous operating temperature: -55 °C to 110 °C

Heat-shrinkable end caps



	Cat. no.	Min. expanded I.D. (in.)	Max. recovered I.D. (in.)	Recovered wall (in.)	Code cable size (AWG) or kcmil	Nom. length (in.)	Std. pkg. qty.
	HSC8-4	0.51	0.16	0.09	#8-#6	2.50	100
	HSC2-20	0.75	0.24	0.09	#6-#2	2.50	100
	HSC30-250	1.10	0.35	0.12	#1-3/0	3.00	50
	HSC300-600	1.50	0.47	0.16	2/0-350	3.25	50
	HSC700-1000	2.00	0.63	0.16	250-500	3.50	50
	HSC750	2.70	0.87	0.16	600-1,000	4.00	10
	HSC300	3.50	1.18	0.16	800-1,250	4.50	5
	HSC500	4.70	1.57	0.17	1,500-2,500	5.50	5

Order multiple is std. pkg.

HSC Series specifications

Property	Test method	Typical performances
Physical		
Tensile strength	ASTM D412, ISO 37	2,100 psi (14.5 MPa)
Elongation	ASTM D412, ISO 37	550%
Elongation after heat aging (168 hrs. at 150 °C)	ASTM D412, ISO 37	500%
Heat shock (4 hrs. at 225 °C)	ASTM D2671	No cracking or flowing
Longitudinal change on recovery	ASTM D2671	+1%, -10%
Low temperature flexibility (4 hrs. at -55 °C)	ASTM D2671	No cracking
Specific gravity	ASTM D792	1.1
Hardness (Shore D)	ASTM D2240	50D
Electrical		
Dielectric strength	ASTM D149, IEC 243	500 V/mil (20 kV/mm)
Dielectric voltage withstand (2500 V, 60 Hz, 1 min.)	UL 486D	No breakdown, 15 kV-4 hrs.
Volume resistivity	ASTM D257	1,016 ohm-cm
Chemical		
Fluid resistance	MIL-DTL-23053	Good to excellent
Fungus resistance	ASTM G21	No growth
Copper corrosion	ASTM D2671	No corrosion
Water absorption	ASTM D570	0.1%
Adhesive		
Adhesive lap shear (1 in./min. at 23 °C)	ASTM D1002	125 psi (0.875 MPa)
Adhesive softening point	ASTM E28	90 °C ±5 °C
Adhesive peel strength (300 mm/min. at 23 °C)		
– To steel, aluminum, P.E.	ASTM D 1000 (mod.)	35 linear lb/in.
– PVC	ASTM D 1000 (mod.)	20 linear lb/in.
Adhesive blocking (30 °C)	ASTM D1146	No blocking
Water penetration	STM 706	No penetration after 236 hrs. of continuous immersion
Room temperature	168 hrs./40 psi	No leaks
Temp. cycling (-40 °C to 60 °C)	50 cycles/15 psi	No leaks
Burst pressure		100 psi (0.70 MPa)

Heavy-wall heat-shrinkable tubing

HSB Series – Heat-shrinkable breakout boots



- Boots for 2-, 3- and 4-way cable breakouts
- Thermoplastic adhesive liner provides complete environmental protection and insulation
- Meets ESI 09-11
- Strain relief and mechanical protection
- Continuous operating temperature: -55 °C to 100 °C
- Shrink temperature of 135 °C

Heat-shrinkable breakout boots

Cat. no.	No. legs	D		d		L	TB	TL	Application legs 600 V conductor (AWG/kcmil)	Std. pkg. qty.
		Expanded dia. (min.) (in.)	Recovered dia. (max.) (in.)	Expanded dia. (min.) (in.)	Recovered dia. (max.) (in.)					
HSB200-75-2	2	1.97	0.90	0.83	0.30	4.69	0.13	0.13	#3–300	10
HSB120-50-3	3	1.50	0.50	0.65	0.16	4.47	0.11	0.11	#8–3/0	10
HSB170-82-3	3	2.20	0.89	1.20	0.35	7.09	0.12	0.12	#1–600	10
HSB240-112-3	3	2.83	1.38	1.46	0.69	7.01	0.16	0.12	300–1,000	10
HSB125-50-4	4	1.83	0.47	0.59	0.12	3.74	0.10	0.08	#12–2/0	10
HSB175-82-4	4	2.36	0.90	1.18	0.25	7.95	0.16	0.13	#4–600	10
HSB265-120-4	4	3.10	1.40	1.50	0.49	9.45	0.13	0.13	3/0–1,000	10
HSB350-138-3	3	3.54	1.34	1.38	0.55	7.87	0.12	0.08	4/0–1,000	5
HSB430-157-3	3	4.33	1.38	1.57	0.69	7.01	0.16	0.12	300–1,000	5
HSB490-200-3	3	4.92	2.32	2.00	1.00	11.14	0.15	0.15	450–1,000	5
HSB520-135-4	4	5.25	3.00	1.35	0.55	10.02	0.13	0.16	4/0–1,000	5

Diagrams

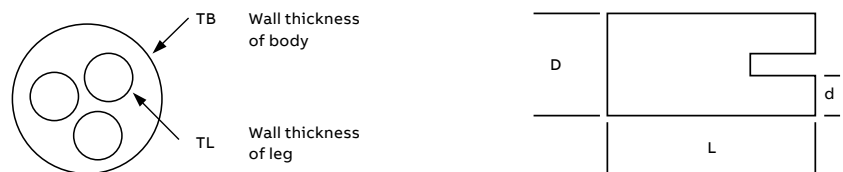

HSB Series specifications

Property	Test method	Typical performances
Physical		
Tensile strength	ASTM D412, ISO 540	2,100 psi (14.5 MPa)
Ultimate elongation	ASTM D412, ISO 540	600%
Elongation after heat aging (168 hrs. at 175 °C)	ASTM D412, ISO 540	520%
Heat shock (4 hrs. at 225 °C)	ASTM2671	No dripping, cracking, flowing
Low temperature flexibility (-55 °C)	ASTM2671	No cracking
Flammability	ASTM D630	Self ext. within 1.97 sec.
Electrical		
Dielectric strength	ASTM D2671	280 V/mil (11 kV/mm)
Chemical		
Water absorption	ASTM D570	0.03%

Medium-wall heat-shrinkable tubing

HSMW Series



3:1 Shrink ratio

- More flexible than heavy-wall products
- Seals and protects cable splices and terminations
- High resistance to impact and abrasion
- Shrink temperature of 120 °C
- Continuous operating temperature: -55 °C to 110 °C
- Thermoplastic adhesive liner guarantees complete environmental protection and insulation
- UV rated (ASTM G53)

Medium-wall heat-shrinkable tubing

Cat. no.	Min. expanded I.D. (in.)	Max. recovered I.D. (in.)	Nominal recovered wall (in.)	Code cable size (AWG) or kcmil	Standard length (in.)	Std. pkg. qty.
HSMW400-48	0.40	0.15	0.08	#4-#14	48	25
HSMW750-48	0.75	0.22	0.08	4/0-#8	48	25
HSMW1100-48	1.10	0.40	0.08	400-#1	48	25
HSMW1300-48	1.30	0.40	0.08	600-#1	48	25
HSMW1500-48	1.50	0.50	0.08	750-3/0	48	25
HSMW1700-48	1.70	0.50	0.08	1,000-2/0	48	25
HSMW2050-48	2.05	0.75	0.08	250-600	48	25
HSMW2750-48	2.75	1.00	0.08	500-1,000	48	15
HSMW3500-48	3.50	1.18	0.10	750-1,250	48	10
HSMW4700-48	4.70	1.57	0.11	1500-2,500	48	10
HSMW6700-48	6.70	2.30	0.11	-	48	10
HSMW9000-48	9.00	3.00	0.12	-	48	5

Order multiple is std. pkg.

HSMW Series specifications

Property	Test method	Typical performances
Physical		
Tensile strength	ASTM D412, ISO 37	2,100 psi (14.5 MPa)
Elongation	ASTM D412, ISO 37	550%
Elongation after heat aging (168 hrs. at 150 °C)	ASTM D412, ISO 37	500%
Heat shock (4 hrs. at 225 °C)	ASTM D2671	No cracking or flowing
Longitudinal change	ASTM D2671	+1%, -10%
Low temperature flexibility (4 hrs. at -55 °C)	ASTM D2671	No cracking
Specific gravity	ASTM D792, ISO/R1183	1.1
Hardness (Shore D)	ASTM D2240	50D
Electrical		
Dielectric strength	ASTM D149, IEC 243	500 V/mil (20 kV/mm)
Dielectric voltage withstand (2500 V, 600 Hz, 1 min.)	UL 486D	No breakdown, 24 kV-1 min., 15 kV-4 hrs.
Volume resistivity	ASTM D257	1,016 ohm-cm
Chemical		
Fluid resistance	MIL-DTL-23053/5, ISO 1817, ISO 37	Good to excellent
Fungus resistance	ASTM G21	No growth
Copper corrosion	ASTM D2671	No corrosion
Water absorption	ASTM D570	0.1%
Adhesive		
Adhesive lap shear (1 in./min. at 23 °C)	ASTM D1002 (mod.)	125 psi (0.875 MPa)
Adhesive softening point	ASTM E28	92 °C/-5 °C
Adhesive peel strength (300mm/min. at 23 °C)		
- To steel, aluminum, P.E.	ASTM D 1000	35 linear lb/in.
- PVC	ASTM D 1000	20 linear lb/in.
Adhesive blocking (30 °C)	ASTM D1146	No blocking
Water penetration	STM 706	No penetration after 286 hrs. of continuous immersion

Thin-wall heat-shrinkable tubing

CPO Series



2:1 Shrink ratio

Thin-wall tubing, non-lined

- Flame-retardant, cross-linked polyolefin
- Continuous operating temperature: -55 °C to 135 °C
- Shrink temperature of 120 °C

- Meets UL and CSA standards; MIL-DTL-23053/ 5 Class 1 and 2; AMS 3636 and 3637; DEF STAN 59-97, Issue 3, Type 2a
- Shelf life 5 years from date of manufacture
- UV rated (ASTM G53)

Thin-wall heat-shrinkable tubing

Cat. no.*	Min. expanded I.D. (in.)	Max. recovered I.D. (in.)	Nom. recovered wall thickness (in.)	Code cable size (AWG) or kcmil
CPO63-_-_-	0.06	0.03	0.02	-
CPO93-_-_-	0.09	0.05	0.02	-
CPO125-_-_-	0.13	0.06	0.02	#24-#30
CPO187-_-_-	0.18	0.09	0.02	#14-#22
CPO250-_-_-	0.25	0.13	0.03	#10-#16
CPO375-_-_-	0.38	0.19	0.03	#6-#12
CPO500-_-_-	0.50	0.25	0.03	#1-#6
CPO750-_-_-	0.75	0.38	0.03	4/0-#2
CPO1000-_-_-	1.00	0.50	0.04	350-2/0
CPO1250-_-_-	1.25	0.625	0.04	1/0-350
CPO1500-_-_-	1.50	0.75	0.04	2/0-500
CPO2000-_-_-	2.00	1.00	0.045	250-1,000

*See catalogue construction to complete.
 UL Recognized and CSA Certified. (NOTE: Clear material not UL Recognized).
 When ordering standard package, order by package not feet.
 Larger diameters available upon special request; contact your regional sales office.
 Order multiple for 4' sticks is 25 sticks.
 Order multiple for reels is 1 reel.

Series	Bulk length (ft)	Series	Bulk reel length (ft)
CPO63 = 1/16 in.	1,000	CPO500 = 1/2 in.	500
CPO93 = 3/32 in.	1,000	CPO750 = 3/4 in.	200
CPO125 = 1/8 in.	1,000	CPO1000 = 1 in.	100
CPO187 = 3/16 in.	1,000	CPO1250 = 1 1/4 in.	100
CPO250 = 1/4 in.	500	CPO1500 = 1 1/2 in.	100
CPO375 = 3/8 in.	500	CPO2000 = 2 in.	100

Catalogue number construction

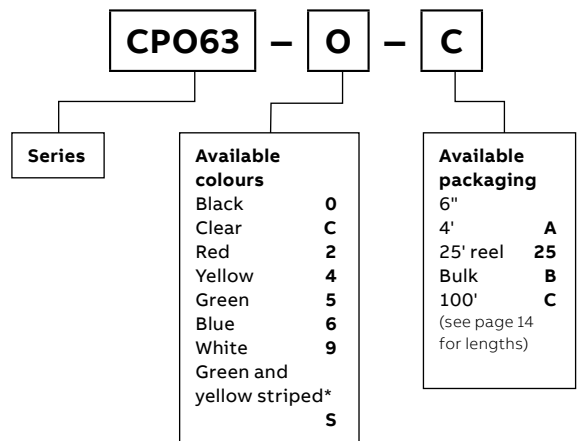

Final order no.
 CPO63-0-C

* Contact your regional sales office for bulk reel quantity

Cat. no.	Min. expanded I.D. (in.)	Max. recovered I.D. (in.)	Nom. recovered wall thickness (in.)	Std. pkg. qty.
CPO63-0-6	0.06	0.03	0.02	20
CPO93-0-6	0.09	0.05	0.02	20
CPO125-0-6	0.13	0.06	0.02	20
CPO187-0-6	0.19	0.09	0.02	20
CPO250-0-6	0.25	0.13	0.03	20
CPO375-0-6	0.38	0.19	0.03	20
CPO500-0-6	0.50	0.25	0.03	10
CPO750-0-6	0.75	0.38	0.03	10
CPO1000-0-6	1.00	0.50	0.04	5

Order multiple is std. pkg.
 Catalogue numbers listed are black colour;
 other colours available upon request.
 Contact your regional sales office.

Thin-wall heat-shrinkable tubing



Shrink-Kon thin-wall heat-shrink kits feature useful colours and sizes in a convenient resealable storage box.

Now brought to you in colour! Shrink-Kon's thin-wall heat-shrink kit features a large assortment of practical colours and sizes for your demanding jobs. Great for identification and adding a professional finishing touch on wire termination projects.

- Over 43 ft. (13 m) of multi-coloured polyolefin thin-wall heat-shrink tubing
- Convenient plastic kit for single storage location
- Individual 6 in. (15 cm) pieces for easy installation
- 2:1 shrink ratio
- UL recognized and CSA certified
- Wide range of sizes – $\frac{3}{16}$ in. (9 mm) to 1 in. (25 mm)

CHS-KIT thin-wall insulation kit

Cat. no.	Description	Weight each kit	UPC code
CHS-KIT	43' (13 m) Assorted colours, sizes – thin-wall heat-shrink tubing in plastic reusable case	1 lb / 0.45 kg	76821092835

Products included in CHS-KIT

Cat. no.	Size in. (mm)	Qty/kit	Colour quantity per kit						
			Black	Clear	Blue	Yellow	Red	Green	White
CPO187+	$\frac{3}{16}$ (5)	36	6	6	4	4	6	4	6
CPO250+	$\frac{1}{4}$ (6)	24	6	4	2	2	4	2	4
CPO375+	$\frac{3}{8}$ (9)	12	2	2	2	–	2	2	2
CPO500+	$\frac{1}{2}$ (12)	6	1	1	1	–	1	1	1
CPO750+	$\frac{3}{4}$ (19)	4	1	1	–	–	1	–	1
CPO1000+	1 (25)	4	1	1	–	–	1	–	1

+Actual catalogue numbers require suffix for appropriate colour

Thin-wall heat-shrinkable tubing



The original black version HS-KIT

- Over 37 ft. (11 m) of black polyolefin thin-wall heat-shrink tubing
- Convenient plastic kit for single storage location
- Individual 6 in. (15 cm) pieces for easy installation
- 2:1 shrink ratio
- UL recognized and CSA certified

HS-KIT thin-wall insulation kit

Cat. no.	Description	Weight each kit	UPC code
HS-KIT	37' (11 m) assorted sizes – black colour thin-wall heat-shrink tubing in plastic reusable case	1 lb /0.45 kg	76821093898

Products included in HS-KIT

Cat. no.	Size in. (mm)	Qty./kit
CPO187-0-6	$\frac{3}{16}$ (5)	32
CPO250-0-6	$\frac{1}{4}$ (6)	20
CPO375-0-6	$\frac{3}{8}$ (9)	8
CPO500-0-6	$\frac{1}{2}$ (12)	6
CPO750-0-6	$\frac{3}{4}$ (19)	4
CPO1000-0-6	1 (25)	4

Thin-wall heat-shrinkable tubing



2:1 Shrink ratio
Custom order lengths for those special jobs.
Custom-cut length of bulk packaging –
Thin-wall tubing

To best meet your requirements for thin-wall heat-shrinkable tubing, ABB welcomes the opportunity to cut bulk reels of tubing. Minimum order requirement is one standard bulk reel, and

multiples thereof. See table for bulk reel length by size. Tubing cannot be cut smaller than ½ in. When ordering custom-cut lengths of tubing, order by piece, not by length. To determine the minimum number of pieces to order, simply figure how many pieces of a specific length of tubing is required to make use of a complete bulk reel.

—
 Cut piece catalogue no. construction

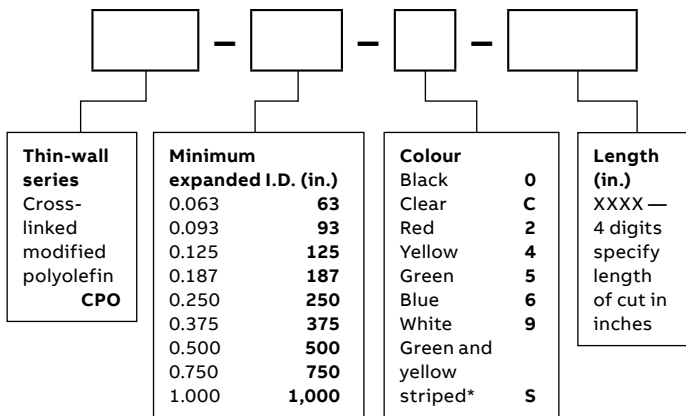

Example 1

If a bulk length of tubing is 1,000 ft. and the desired length of each individual piece is 6 in., the minimum order requirement is 2,000 pieces.

Given (length of reel) 1,000
 Convert to inches by multiplying by 12 12 x 1,000
 Length of reel in inches 12,000
 Divide by desired length 2,000 ÷ 6
 Total number of 6 in. pieces in a 1,000' reel (minimum order) 2,000

Example 2

If a bulk reel of tubing is 400 ft. and the desired length of each individual piece is 2 in., the minimum order requirement is 2,400 pieces.

Given (length of reel) 400
 Convert to inches by multiplying by 12 12 x 400
 Length of reel in inches 4,800
 Divide by desired length 4,800 ÷ 2
 Total number of 2 in. pieces in a 400' reel (minimum order) 2,400

Contact your regional sales office for pricing and availability on cut pieces.

—
 CPO Series specifications

Property	Test method	Typical performances
Physical		
Tensile strength	ASTM D412, ISO 37	2,200 psi (15.0 MPa)
Elongation		400%
Longitudinal change	ASTM D2671	+1%, -10%
2% Secant modulus		16,000 psi (110 MPa)
Specific gravity	ASTM D792, ISO/R1183	1.3 in. (colours) 0.95 in. (clear)
Restricted shrinkage	ASTMD2671	No cracking
Elongation after heat aging (168 hrs. at 175 °C)		350%
Heat shock (4 hrs. at 250 °C)		No cracking or flowing
Low temperature flexibility (4 hrs. at -55 °C)		No cracking or splitting
Flammability		Flame-retardant (except clear)
Electrical		
Dielectric strength	ASTM D2671, IEC 243	600 V/mil (24 kV/mm)
Volume resistivity	ASTM D2671	1,016 ohm-cm
Chemical		
Fluid resistance	MIL-DTL-23053/5, ISO 1817, ISO 37	Good to excellent
Fungus resistance	ASTM G21	No growth
Copper corrosion	ASTM D2671	No corrosion
Water absorption	ASTM D570	0.2%

Thin-wall heat-shrinkable tubing

CPO-A Series

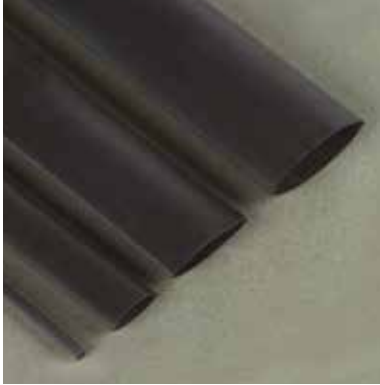

3:1 Shrink ratio

Thin-wall, adhesive lined

- Adhesive lined for moisture-proof environmental seal
- High 3:1 shrink ratio for covering irregularly shaped objects
- Continuous operating temperature: -55 °C to 110 °C
- Shrink temperature: 120 °C
- UV rated (ASTM G53)

Thin-wall heat-shrinkable tubing

Cat. no.	Min. expanded I.D. (in.)	Max. expanded I.D. (in.)	Nom. recovered wall (in.)	Code cable size (AWG)	Standard length (in.)	Std. pkg. qty.
CPO-A-125-48	0.13	0.02	0.04	#24-#30	48	25
CPO-A-187-48	0.18	0.06	0.05	#14-#22	48	25
CPO-A-250-48	0.25	0.08	0.05	#10-#22	48	25
CPO-A-375-48	0.38	0.14	0.05	#6-#16	48	25
CPO-A-500-48	0.50	0.19	0.07	#2-#12	48	25
CPO-A-750-48	0.75	0.31	0.07	3/0-#4	48	25

Note: Non-standard colours, sizes and lengths available subject to your regional sales office quotation.
Standard colour: Black

CPO-A Series specifications

Property	Test method	Typical performances
Physical		
Tensile strength	ASTM D412, ISO 37	2,200 psi (15.0 MPa)
Elongation	ASTM D412, ISO 37	400%
Heat shock (4 hrs. at 250 °C)	ASTM D2671	No cracking or flowing
Longitudinal change	ASTM D2671	±5%
Low temperature flexibility (4 hrs. at -55 °C)	ASTM D2671	No cracking
Specific gravity	ASTM D792, ISO/R1183	1.1
2% Secant modulus	ASTM D2671	1600 psi (110 MPa)
Heat-resistant properties (168 hrs. at 175 °C)	MIL-DTL-23053/4	240%
Flammability	ASTM D2671	Moderately flame retardant
Electrical		
Dielectric strength	ASTM D2671, IEC 243	600 V/mil (24 kV/mm)
Volume resistivity	ASTM D2671	1016 ohm-cm
Chemical		
Fluid resistance	MIL-DTL-23053/5, ISO 1817, ISO 37	Good to excellent
Fungus resistance	ASTM G21	No growth
Copper corrosion	ASTM D2671	No corrosion
Water absorption	ASTM D570	0.2%

Thin-wall heat-shrinkable tubing

CHS Series – Clear thin-wall PVC heat shrink



Thin-wall heat-shrinkable tubing

- Clear shrink enables user to inspect die and crimp details after installation
- Flexible PVC tubing is suitable for industrial and electronic applications
- UL Listed, VW-1 rated
- CSA certified
- Flame-retardant
- Low shrink temperature of 110 °C
- Dielectric strength — 600 V/mil



	Cat. no.	Min. expanded I.D. (in.)	Max. recovered I.D. (in.)	Nominal recovered wall (in.)	Code cable size (AWG) or kcmil	Std. length (ft.)	Std. pkg. qty.
	CHS18	0.13	0.06	0.02	#22-#18	50	1
	CHS18B	0.13	0.06	0.02	#22-#18	250	1
	CHS14	0.25	0.13	0.03	#16-#10	50	1
	CHS14B	0.25	0.13	0.03	#16-#10	250	1
	CHS38	0.38	0.19	0.03	#8-#6	50	1
	CHS38B	0.38	0.19	0.03	#8-#6	250	1
	CHS12	0.50	0.25	0.03	#4-#2	50	1
	CHS12B	0.50	0.25	0.03	#4-#2	250	1
	CHS34	0.75	0.38	0.04	#1-3/0	50	1
	CHS34B	0.75	0.38	0.04	#1-3/0	250	1
	CHS100	1.00	0.50	0.04	4/0-300	25	1
	CHS100B	1.00	0.50	0.04	4/0-300	100	1
	CHS112	1.50	0.75	0.04	350-700	25	1
	CHS112B	1.50	0.75	0.04	350-700	100	1
CHS200	2.00	1.00	0.04	750-1,000	25	1	
CHS200B	2.00	1.00	0.05	750-1,000	100	1	

Standard package is in reels. Order by reel; not by feet

CHS Series specifications

Property	Test method	Typical performances
Physical		
Tensile strength	ASTM D412, ISO 37	3,300 psi (23.0 MPa)
Elongation	ASTM D412, ISO 37	300%
Longitudinal change	ASTM D2671	±10%
2% Secant modulus	ASTM D2671	16,000 psi (110 MPa)
Specific gravity	ASTM D792, ISO/R1183	1.31
Elongation after heat aging (168 hrs. at 136 °C)	ASTM D2671, ISO 37	250%
Heat shock (4 hrs. at 250 °C)	ASTM D2671	No cracking or flowing
Low temperature flexibility (1 hrs. at 10 °C)	ASTM D2671	No cracking or slitting
Flammability	ASTM D2671	Self-extinguishing
Electrical		
Dielectric strength	ASTM D2671, IEC 243	600 V/mil (24 kV/mm)
Volume resistivity	ASTM D2671	1,016 ohm-cm
Chemical		
Fluid resistance	MIL-DTL-23053/5, ISO 1817, ISO 37	Good to excellent
Fungus resistance	ASTM G21	No growth
Copper corrosion	ASTM D2671	No corrosion
Water absorption	ASTM D570	0.3%

Splice Insulators and insulating covers

H-Tap insulating covers (hard covers)



- Interlocking insulating covers for H-type compression taps
- Easy installation: place the H-tap in the cover and snap the cover closed
- Consult your regional sales office for flame-retardant version
- Can also be used on C-taps

Specifications

- HTC2 and HTC2S use insulation wrap instead of end cushions for inner seal
- Connector cat. nos. 54755 through 54790 and 63148 through 63180 require hydraulic crimping tools; refer to instruction sheets
- Outer hard shell covers: high-impact black thermoplastic (Noryl) flammability class, UL 94V-1
- Inner seal: Black neoprene sponge soft closed cell, oxygen index 28% UL 94 HBF
- Temperature rating: 90 °C maximum
- Voltage rating: 600 V maximum



Diagram	Cat. no.	Nominal dimensions (in.)			Std. pkg. qty.
		A (length)	B (thick.)	C (width)	
	HTC2S	2	1.13	1.44	15
	HTC2	3.5	1.13	1.44	15
	HTC40	4.25	1.56	2	2
	HTC500	6	1.75	2.75	8
	HTC1000	7	2.38	3.88	2
	HTC1000L	10	2.38	3.88	3

For H-tap applications

Cover cat. no.	Al/Cu H-tap no.	Cu H-tap
HTC2	63105	-
HTC2S	-	CHT814-10
HTC40	63110	CHT214-9
HTC40	63118	CHT250214-8
HTC40	63125	CHT2514-7
HTC40	63140	CHT2502-6
HTC500	63148	CHT50010-5/CHT50040-4
HTC500	63160	CHT75010-3/CHT750350-2
HTC1000L	63170	-
HTC1000	63180/63169	CHT750350-1F

For C-tap applications

Cover cat. no.	C-tap no.	Colour code
HTC40	54720	Brown
HTC40	54725	Green
HTC40	54730	Pink
HTC40	54755	Blue
HTC40	54760	Brown
HTC40L2	54735	Black
HTC40L2	54740	Orange
HTC40L2	54745	Purple
HTC40L2	54750	Yellow
HTC500	54765	Pink
HTC500	54770	Black
HTC500	54775	Yellow
HTC500	54780	White
HTC500	54785	-
HTC1000	54790	-

Splice insulators and insulating covers

H-tap insulating covers (soft covers)



- Eliminates taping
- Provided with three positive locking latches and overlapping fringe for maximum cable insulation

Specifications

- Rating: 90 °C, 600 V
- Material: Flame-retardant, high-impact polypropylene
- Colour: Black



Cat. no.	Wire range (AWG or kcmil)		Installs "H" tap cat. no.	Std. pkg. qty.
	Min.	Max.		
HT20C	6	2/0	63110 and 63125	50
HT40C	6	4/0	63140 and 63148	25
HT600C	2	500	63160 and 63169	10
HT1000C	1/0	750	63180	5
HT1000C-L	1/0	1,000	63170	5

Order multiple is std. pkg.

H-tap insulating covers

Diagram	Cat. no.	Wire range (AWG or kcmil)		Use to insulate ABB H-taps	Dimensions (in.)		
		Max.	Min.		A	B	C
	HT20C	2/0	6	6110/63115 63125/63120	4.5	1.25	1.13
	HT40C	4/0	6	63140 63148	5.61	1.41	1.19
	HT600C	500	2	63160/63169	6.81	2.13	1.45
	HT1000C	100–500	250–1/0	63180	[184.15 mm] 7.250	2.330 +0.060	–
	HT1000C-L	1,000–500	250–250	63170	[263.40 mm] 10.374	2.330 +0.060	–

(C) Height, typical both halves

Splice insulators and insulating covers

Adhesive insulating covers



- Seals against moisture
- Voltage rating up to 600 V
- Workable from -10 °C to 49 °C (14°F to 120°F)
- Maximum operating temperature of 80 °C (176°F)
- No installing tools required

Electrical

- Dielectric constant: 3.2 ASTM-D150 (60 Hz)
- Power factor: 0.07 ASTM-D150 (60 Hz)
- Dielectric strength: 340 V/mil ASTM-D1373

Chemical

- Water absorption: 0.06% ASTM-570
- Ozone resistance: excellent: 0.03% ASTM-D1373
- Corrosion: none visible per ASTM-D 69
- UL listed – for use with ABB covers
- For H-taps, C-taps, two-way connectors, mechanical taps, and Color-Keyed® lugs and joints
- Material: 6 mil vinyl backing, butyl rubber mastic adhesive thickness 3/8 in. approx. Polyethylene release sheet
- Not for submersion in liquid



Diagram	Cat. no.	A (in.)	B (in.)	Std. pkg. qty.
	AC 5 x 3	5	3	10
	AC 5 x 7	5	7	10
	AC 85 x 75	8.5	7.5	5
	AC 85 x 105	8.5	10.5	5

Order multiple is std. pkg.

Adhesive insulating cover cat. nos.	Compression lug cat. nos.		Compression two-way connector cat. nos.		H-tap cat. nos.	C-tap cat. nos.	Compression cable joint cat. nos.									
AC5X3	60096	60113	60130	60150	54132	54145	54160	54207	54906	54860	60500	-	54806	63105	54710	54610
Size key #2	60097	60114	60150	60151	54134	54108	54162	54208	54942	54862	60501	-	54807	-	54715	54615
	60099	60016	60230	60230	54105	54147	54163	54255	54947	54864	60507	-	54806	-	54720	54620
	60101	60017	60236	60236	54135	54148	54111	54209	54909	54866	60512	-	54504	-	54725	54625
	60102	60018	60238	60238	54136	54150	54165	54210	54910	-	60516	-	54505	-	54730	54630
	60103	60120	60242	60242	54138	54152	54167	54260	54965	-	60905	-	54506	-	54735	54635
	60104	60122	60244	60244	54106	54153	54168	54211	54970	-	60910	-	54507	-	54740	-
	60106	60123	60248	60248	54139	54109	54112	54265	54850	-	60915	-	54506	-	54745	-
	60107	60124	60250	60250	54140	5415	54170	54212	54852	-	60920	-	54509	-	54750	-
	60108	60126	54104	54104	54107	54157	54204	54270	54854	-	60925	-	54500	-	-	-
	60109	60128	54130	54130	54142	54158	54205	54930	54856	-	54804	-	54511	-	-	-
	60112	60129	54131	54131	54143	54110	54206	54905	54858	-	54805	-	-	-	-	-
AC 5 x 7	-	60152	60169	60267	54173	54115	54129	54222	54920	-	60522	60945	54516	63110	54755	54640
Size key #4	-	60153	60174	60268	54174	54183	54213	54291	54923	-	60530	60950	54518	63115	54760	54645
	-	60154	60172	60269	54113	54116	54275	54223	54928	-	60538	60955	54809	63120	54765	54650
	-	60156	60174	60271	58161	54185	54214	54295	54868	-	60542	60960	54810	63125	54770	-
	-	60157	60176	60276	58162	54118	54280	54224	54870	-	60548	60965	54811	-	54775	-
	-	60159	60178	60274	58163	54187	54215	54226	54872	-	60554	60970	54812	-	54780	-
	-	60160	60180	60275	58165	54120	54282	54228	54874	-	60560	54509	54813	-	-	-
	-	60162	60254	60276	58166	54122	54216	54913	54876	-	60565	54510	54814	-	-	-
	-	60163	60256	60277	54178	54123	54218	54914	54878	-	60568	54511	54815	-	-	-
	-	60165	60260	60278	54179	54124	54286	54915	54880	-	60574	54512	54816	-	-	-
	-	60166	60262	60280	54114	54126	54220	54916	54882	-	60930	54513	54817	-	-	-
	-	60168	60265	54172	54181	54128	54289	54918	-	-	60935	54514	-	-	-	-
	-	-	-	-	-	-	-	-	-	-	60940	54515	-	-	-	-
AC85 x 75	-	-	-	-	60184	-	-	-	-	-	60574	-	54522	63130	-	-
Size key #6	-	-	-	-	60284	-	-	-	-	-	60576	-	54523	63135	-	-
	-	-	-	-	-	-	-	-	-	-	60578	-	54524	63140	-	-
	-	-	-	-	-	-	-	-	-	-	60580	-	54526	63145	-	-
	-	-	-	-	-	-	-	-	-	-	60584	-	54528	63150	-	-
	-	-	-	-	-	-	-	-	-	-	60975	-	54820	-	-	-
	-	-	-	-	-	-	-	-	-	-	60980	-	54823	-	-	-
	-	-	-	-	-	-	-	-	-	-	60985	-	54828	-	-	-
	-	-	-	-	-	-	-	-	-	-	54520	-	-	-	-	-
AC85 x 105	-	-	-	-	-	-	-	-	-	-	-	-	-	63155	-	-
Size key #8	-	-	-	-	-	-	-	-	-	-	-	-	-	63160	-	-
	-	-	-	-	-	-	-	-	-	-	-	-	-	63165	-	-

Splice insulators and insulating covers

Self-fusing insulation tape



Once you try it, you'll wonder what you ever did without it. Quick and easy insulation, no heat or adhesive required.

You won't believe how easy it is to use Shrink-Kon Self-Fusing Insulation Tape to insulate splices, terminations and connections. Forget the heat gun and adhesive. Two layers of this self-amalgamating tape form a flexible dielectric layer that protects your connection against moisture, humidity and corrosion. The tape offers high tensile strength, enabling you to stretch the first layer of tape to form a solid, compressed, watertight seal. Apply the second layer with minimal to no stretch, and your insulation job is complete.

- Just two layers form a moisture-proof, abrasion-resistant, dielectric seal
- Suitable for high and low voltage applications
- Smooth filler putty compound available for use under tape when insulating bolted or dimensionally inconsistent splices and terminations



Cat. no.	Width (in.)	Length (ft.)	Thickness (mils)	Colour	Std. pkg. qty.
Self-fusing insulation tape					
TBFT421-12	1	12	40	Red	10
TBFT421-36	1	36	40	Red	10
TBFT201-36	1	36	20	Black	10
Smooth filler putty compound					
TBFP9-2	1	2	–	White	1

Standard package is rolls. Order by rolls; not by feet.

Splice insulators and insulating covers

Self-fusing insulation tape

—
01 TBF421-36
—
02 TBF9-2

Features and benefits

- Requires no heat gun or adhesive to form a moisture-proof abrasion-resistant bond
- Easy-release, non-static-sensitive, high-visibility liner peels right off
- Self-fusing tape material adheres to itself for ease of installation
- Creates an immediate, permanent bond even when wet – no waiting period
- Stable even under extreme temperatures: -90 °C to 260 °C (-130 °F to 500 °F)
- UV, radiation, arc-track, ozone, steam, moisture and saltwater-resistant
- Easily removable – just slice with a knife and pull off – leaves no residue
- Repair deteriorated insulation on cables and conductors
- Insulate and seal underground and above-ground bonding installations
- Insulate harnessing, bundling, cabling and wiring in aircraft, automotive, marine and other industrial machinery/equipment
- Motor connections
- Protects against vibration, scratching and moisture

Specifications

- Material: modified silicone rubber compound
- Tensile strength: 1,200 psi (82737 kPa)
- Dielectric strength: 20 mil: 600 VPM; 40 mil: 800 VPM
- Abrasion resistance: 110 lb/in. (49,89 kg/po)
- Water absorption: < 0.5 %
- Temperature range: -90 °C to 260 °C (-130 °F to 500 °F)

Typical applications:

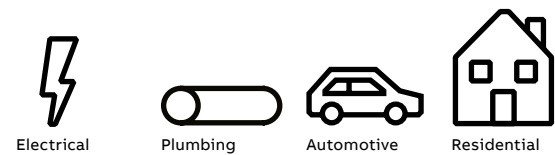

—
01



—
02

Splice insulators and insulating covers

Motor stub splice insulators



- Re-enterable motor stub insulator
- Easy installation
- No special tools required
- Permits inspection of connector joint by simply removing the snap-on cap.
- Wide cable range, long life
- UL Listed and CSA Certified (UL 94V-1 flammability class)
- Rated for 600 V and 90 °C application
- Material body: modified neoprene elastomer
straps: nylon

This innovative product has been designed to insulate motor stub splices quickly, easily and dependably. It consists of a boot-type insulator with integral Ty-Rap® cable ties. To install, simply position the insulator over the bolted splice and tighten the cable ties. That's all there is to it. It produces uniform, high-quality installations every time... in about 30 seconds. The completed installation is immediately ready for inspection and use. If required, the insulator can be easily removed. Simply snip the cable ties and slide the insulator off the splice. It leaves no sticky residue.



	Cat. no.	Wire range (AWG or kcmil)	Length A (in.)	Bolt max. (in.)	Dia. B (in.)	Dia. C (in.)	D (in.)	E (in.)	Std. pkg. qty.
<p>Diagram</p>	MSC14*	#14-#10	1.5	0.38	0.56	0.50	0.38	0.35	15
	MSC8	#12-#8	2.39	0.38	0.76	0.67	0.38	1.20	10
	MSC2	#12-#2	3.25	0.75	0.95	0.88	0.38	1.5	10
	MSC20	#2-2/0	4.25	1.0	1.39	1.05	0.43	1.70	4
	MSC250	3/0-300	7.56	1.5	1.88	1.80	0.45	1.90	2
	MSC500	350-500	8.88	1.75	2.56	2.48	0.45	2.10	5

*One Ty-Rap cable tie only
Order in multiples of std. pkg.

Installation tools



Portable heat shrink torch

Separate fuel- and air-flow controls enable precise adjustment of flame and temperature to 1,371 °C (2,500 °F).

- 1,371 °C (2,500 °F) output capacity satisfies virtually any heat-shrink, brazing or soldering requirement
- Dual fuel- and air-flow controls enable separate adjustment of temperature and flame precision
- Brass and steel construction provides durability

Specifications

- Dimensions (without base): 3.9 in. L x 1.4 in. W x 5.4 in. H
- Weight (when filled): 9.88 oz.
- Fuel tank capacity: 2.03 fl. oz.
- Operating time (per full fuel tank): Up to 220 minutes

Portable heat shrink torch

Cat. no.	Description	Std. pkg. qty.
WT-PTORCH	Shrink-Kon portable heat-shrink torch	1

Order multiple is std. pkg.



Electric heat gun

- UL Listed and CSA certified
- 232 °C to 649 °C heat range (450 °F to 1,200 °F)
- 120 VAC 60 Hz

Electric heat gun



Cat. no.	Description	Std. pkg. qty.
WT1400	Dual temp. heat gun. 600 °F / 900 °F, 1,300 W, 120 VAC 60 Hz	1

Order multiple is std. pkg.

Installation guidelines and cross reference

— 01 Connector and heat-shrinkable tubing prior to installation.

— 02 Crimp connector installed.

— 03 Heat-shrinkable tubing in position.

— 04 Heat-shrinkable tubing after heat application.

No special installation skills required

1. Remove any oil, grease, water, dirt, etc., by wiping the cable ends and connector. Remove all sharp edges and burrs from connector.
2. Center tubing over splice connector.
3. Use the light blue outer portion of the flame when using the SIT-1 torch. Do not hold the torch still in one position or concentrate the hot inner flame of the torch on the tubing; this may cause scorching.
4. Begin heating tubing in the center. Recover the central portion of the tubing first by heating around the circumference of the splice. (Keep heat source moving constantly around the circumference of the insulator to ensure uniform shrinkage of the insulator.)
5. Continue heating around the tubing and out toward one end. Move torch around the tubing until one end is completely recovered.
6. Repeat the above procedure on the opposite end of the splice, again working the source from the center outward and around the tubing.
7. Installation is complete when the tubing conforms to splice and sealant flow is apparent at both ends.

Safety warning: Keep clothing and body parts away from flame.

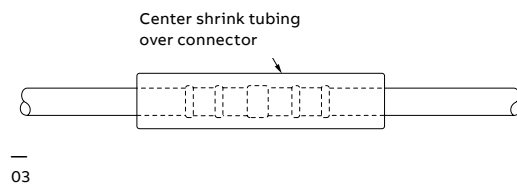
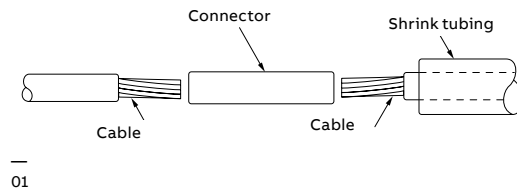

Typical specifications

Insulating and sealing of all 600 V, in-line cable splices from #16 AWG through 1,000 kcmil shall be done in accordance with the instructions provided with the Shrink-Kon shrinkable insulators, catalogue series HS.

The connector insulator must be made of thermally stabilized, homogeneous polyolefin having internally applied sealant. It must have Underwriter's Laboratories Listing (UL 90 °C, 600 V) and be approved for the use. It must be usable without additional covering or adhesive both indoors and outdoors, in overhead, direct burial or submersed applications at rated voltage. It must not be adversely affected by moisture, ozone, oils, fuels, mild acids and alkalis, or ultraviolet light. It must be compatible with all commonly used cable jacket materials, including rubber, plastic, lead, steel, aluminum and copper.

Factory-applied sealant

A standard sealant is coated on the entire inside surface of most precut sizes. Tubing is also available without sealant — consult factory. The sealant is rated for continuous 90 °C operation on non-pressurized cable systems and aids in sealing out moisture and corrosion.

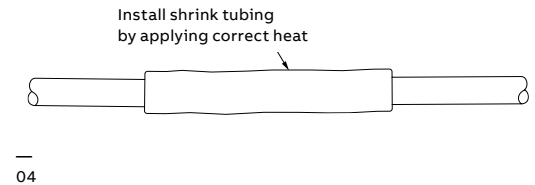
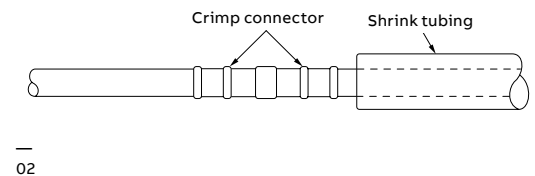

Installation guidelines and cross reference

Cost and reliability of heat-shrinkable tubing compared to tape

The cost differential in the installation of ABB heat-shrinkable tubing over taping can result in up to a 34% savings in labor and overhead. For example, on a 2/0 AWG aluminum splice, heat-shrinkable tubing can be installed in 3 minutes, versus 10 minutes of taping. In addition to the direct cost reduction, there are the advantages of assured uniformity of wall thickness and moisture sealing.

Cross reference

ABB	Panduit	3M	Raychem	Sumitomo	Alpha	Coleflex	Insultab
CPO	HSTT and HSTTM	FP 301 (1 and 2)	RNF 100 (1 and 2)	A2 and B2	FIT 221	ST221 / STS221	HS 101
CPO-A	HSTTA and HSTTVA	EPS300	TAT 125 ATUM 3:1	W3B2	FIT321	ST303	HS101 MW 3:1
HSMW	-	-	MWTM (U) BSTS-M / SST-M	-	-	-	CTV
HS	-	-	WSCM / SST	-	FIT700	-	-
HS FR	HST	HDT	BSTS FR / SSTFR WCSF / FCSM	-	-	-	CTVH
HSC	HSEC	ICEC	S3C/ESC SSC-FR / ESC-FR	-	-	TYT	-
CPO-HF	-	-	-	NH	-	-	-
HSM-HF	-	-	XFFR	-	-	-	-
CHS	-	-	-	-	-	-	-

Break-away connector kits

- 01 Line side housing (receptacle)
- 02 Crimp-on fuse holder*
- 03 Load side housing (plug)
- 04 Crimp-on fuse holder*
- 05 Line side housing (receptacle)
- 06 Crimp-on fuse holder*
- 07 Crimp-on fuse holder*
- 08 Load side housing (plug)
- 09 Crimp-on fuse holder*
- 10 Crimp-on fuse holder*

Features/benefits:

- Completely waterproof
- Individual fusing allows separation of kit without de-energizing complete circuit
- Break-away style fuse holder eliminates risk of electrical shock
- Exposed current-carrying components are all contained in harmless load side of the kit
- Readily identifiable problem area simplifies maintenance
- Easy to install, no need for tapes or compounds
- Insulated to 600 V

Applications:

- Roadway lighting fixtures
- Flood and area lighting fixtures
- Power distribution systems

Style 65 break-away

Type: Single pole in-line

Electrical rating: For 600 V, 10–30 A, 1³/₃₂ in. x 1¹/₂ in. fuse*

Cat. no.	Conductor size (AWG)	Conductor material	Packaging unit	Packaging standard
65 U	#14–#6	Copper	1	20

*Fuse not included with kit. Do NOT use glass fuses.

Max. overall length, installed, 7¹/₄ in. diameter 1¹/₈ in.



Style D65 break-away

Type: Double pole in-line

Electrical rating: For 600 V, 10–30 amp., 1³/₃₂ in. x 1¹/₂ in. fuse*

Cat. no.	Conductor size (AWG)	Conductor material	Packaging unit
D65 U	#14–#6	Copper	20

*Fuse not included with kit. Do NOT use glass fuses.

Max. overall length, installed, 7¹/₄ in. diameter 2¹/₈ in.

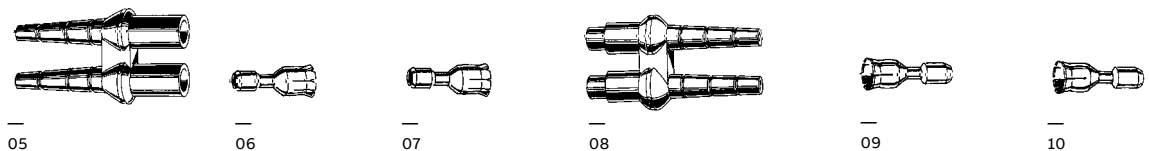

Break-away connector kits

Installation instructions for 65 and D65 fused connector kit

Contents:

1. Line side (female) rubber housing
2. Load side (male) housing
3. Metal fuse sockets (4 in D65 kits)
4. Fuse (not provided)

- Assembly dowel
- Lubricant
- Wiper

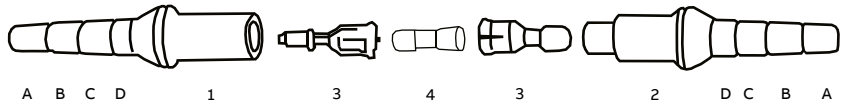

Table 1 — outside diameter

	Cable OD (in.)
A	0.120–0.205
B	0.195–0.260
C	0.250–0.330
D	0.320–0.430

Table 2 — Universal contact



Crimp area	Conductor size in AWG		Recommended crimp tools and dies	
	Stranded	Solid		
A	14	12, 14	ABB No. WT111M	“C” cavity
A	10, 12	8, 10	ABB No. WT111M	“C” cavity
B	6	6	ABB No. TBM41E/45S	“Blue” cavity
B	6	4	ABB No. TBM41E/45S	“Blue” cavity

- | | |
|---|---|
| <p>Step 1 Measure cable diameter and from Table 1, select corresponding section on molded sleeve. Cut off remaining sections of housing to size required. Example: If cable OD is 0.270 in., it falls within the “C” range – cut between “B” and “C”.</p> <p>Step 2 Thoroughly clean approximately 8 in. of the line side cable to be inserted using the wiper provided. Apply lubricant to cable and small hole in line side (receptacle) housing.</p> <p>Step 3 Insert cable through the small hole in the housing, and push through sufficiently to allow for stripping of insulation.</p> <p>Step 4 Strip wires ¾ in. for wire 14 AWG through 10 AWG, ⅝ in. for wire sizes 8 AWG through 4 AWG. (do not pencil insulation). Crimp on line side socket. (Refer to Table 2 for suggested tool and die.)</p> <p>Step 5 Apply lubricant lightly to the outside of the metal fuse socket.</p> | <p>Step 6 Place wooden dowel in the socket. Place the free end of the dowel against a firm surface and push the housing forward until it snaps into a locking position. Wipe off any excess lubricant.</p> <p>Step 7 Repeat the above steps with the load housing.</p> <p>Step 8 Insert a 1³/₃₂ in. by 1-½ in. HRC fuse, 600 V 30 A max. (Bussmann KTK series or equivalent), in the load side housing. Caution: When the fuse is fully seated, not more than ¼ in. of the fuse barrel will be visible between the fuse end cap and the housing. Do not apply lubricant on the fuse.</p> <p>Step 9 Plug the load side and line side housings together. Caution: When properly mated, the seam between the housings should not exceed ½ in.</p> <p>Step 10 The connection is now complete. For best results, anchor the line side wire, so that if the load side wire is pulled (perhaps someone has knocked over a pole), the kit will come apart.</p> |
|---|---|

D

Pos-E-Kon® - Industrial connectors



—
D

Pos-E-Kon - Industrial connectors

Table of contents

Section D

Overview	D4
A Series 16 A, 600 V AC	D16
B Series 16 A, 600 V AC	D18
C Series 35 A, 600 V AC	D22
D Series 10 A, 600 V AC	D24
DD Series 10 A, 600 V AC	D28
K Series 80 + 16 A, 600 V AC	D32
V Series 16 A, 600 V AC	D34
T Series 16 A, 600 V AC	D38
Technical information	D40

Overview

The FAQs about Pos-E-Kon interconnects

ABB interconnects adhere to international standards and are used worldwide to provide a high degree of reliability in electrical wiring.

Why?

Rectangular circuit interconnections

- Best use of space for multiple contacts in heavy-duty housings
- Easy to assemble with many different insert options
- Best fit for easy access in panels, machinery and enclosures
- Sealed connector with quick disconnect handles
- Wide variety of circuit possibilities from standard items
- Solid or stranded wire in fixed or portable use

Who?

- Machine tool OEMs
- Material handling equipment OEMs
- Robotics systems OEMs and installations
- Packaging machinery OEMs and facilities
- Control panels and PLC systems
- Molding, assembly or line machinery OEMs and facilities
- Construction, mining and welding apparatus
- Carnival applications

What?

- Servo controls
- Sensing and feedback loops
- Conveyor and process controls
- Low power, DC or logic systems
- Combination power, system and other circuits
- Modular controls including fiber-optic connections

Where?

Worldwide agency approvals and applications

- DIN VDE 0627/86, 0110/02.79, and 0110-1/04.97
- IEC 60.664-1, DIN/IEC 512
- UL® recognized (E215386) and CSA certified
- Protection classes IP44 through IP65 per IEC 529
- Component use in CE marked equipment OK per IEC
- Council Directive July 1999, 73/23/EEC
- Available from ABB – Pos-E-Kon authorized distributors
- ABB sales representatives and agents worldwide

DIN standard configurations

- Most inserts and housings are interface compatible with other DIN standard lines. Verify physical application before selecting cross reference.
- Pos-E-Kon construction includes standard NPT conduit adapters for hoods and bases, with many options available. DIN standard Hoods and Bases may have “Euro Style” PG fittings (or none) included unless specially ordered.

The basic system: build an application

- Step 1** – Maximum voltage and amperage requirements (300 V or 600 V classes, 10–80 A).
- Step 2** – Number of contacts or circuits needed.
- Step 3** – Choose wire terminations style; screw terminal or crimp contacts. Select series from charts.
- Step 4** – Base (or coupler) and hood construction/ mating selection per series (single or double levers).



01

- 01 Hood
- 02 Base housing (or coupler hood)

Step 1

Hood:

- Separable housing for inserts
- Top or side conduit/wire entry
- Standard locking posts, dual or single
- Locks to panel base, box base or inline coupler hood



02

Step 2

Base housing (or coupler hood):

- Surface wall-mount box base (shown)
- Panel base for through-panel access
- Coupler hood mating for portable use
- Single or dual “lever” locking



03

- 03 Male insert
- 04 Female insert

Step 3

Male insert:

- Male contact carrier body
- Screw terminal contacts (pins with wire protection saddles) or crimp terminated pins

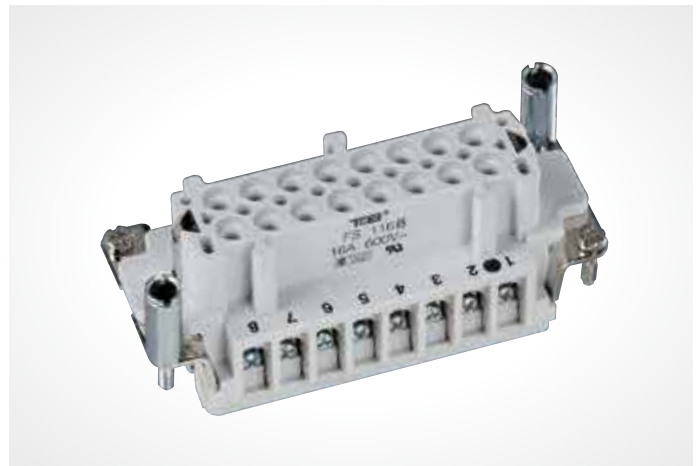

04

Step 4

Female insert:

- Female contact carrier
- Screw terminal contacts (sleeves with wire protection saddles) or crimp terminated sleeves

Overview

Pos-E-Kon insert selector chart

S – Screw terminals **C** – Crimp contacts
F – Fiber optic (POF) **A** – Terminal block wiring adapter



Select the number of contacts – All inserts have separate ground contacts

Amps	Volts	Series	3	4	6	7	8	10	12	15	16	20	24	25	26	32	40	42	48	50-216	
10	50	D	-	-	-	-	C, F	-	-	-	-	-	-	-	-	-	-	-	-	-	
10	600	A	S	S	-	-	-	-	-	-	-	-	-	-	-	-	-	-	-	-	
16	600	A	-	-	-	-	-	S, C	-	-	S, C	-	-	-	-	S, C	-	-	-	-	
16	600	B	-	-	S, C, A	-	-	S, C, A	-	-	S, C, A	-	-	-	-	S, C	-	-	S, C	-	
35	600	C	-	-	S	-	-	-	S	-	-	-	-	-	-	-	-	-	-	-	
10	600	D	-	-	-	C, F	-	-	-	C, F	-	-	-	C, F	-	-	C, F, A	-	-	C, F, A (64)	
10	600	DD	-	-	-	-	-	-	-	-	-	-	C, F	-	-	-	-	C, F	-	C, F	
80/16	600	K	-	S	-	-	S	4 or 8 Power (80 A alone or with 8 or 16 control (16 A) combination inserts)													
16-T	600	T	-	-	S	-	-	S	-	-	S	-	S	High temp (200 °C)							
316-V	600	V	S, C	-	S, C	-	-	S, C	-	-	S, C	S, C	-	-	S, C	S, C	Includes 2 pilot contacts				

10-16 A A, B, V, T	35 A C	10-80 A K
		







Screw terminal/Insert types (Integral contacts)

Screw termination is used for ease of assembly plus ease of maintenance. No tooling beyond a screwdriver and wire strippers is required.

10 A D & DD	16 A A & B
	

Crimp terminal/insert types (Crimp contacts)

Crimp terminals offer solid, thermally cool vibration-resistant terminations for OEM equipment and critical applications. Better for smaller AWG sizes also. Crimp tools are noted in each section.

10-16 A A, B	10 A D & DD	POF D
		
		

All crimp types represented require contacts ordered separately. Each section contains hand crimp tool selection notes



01

- 01 Screw terminal inserts
- 02 Crimp terminal inserts
- 03 Terminal block wiring adapters

Screw terminal inserts*

- Integral screw terminal contacts provide for easy terminal wiring and fast assembly
- Standard wire protection saddles prevent cutting of strands during assembly

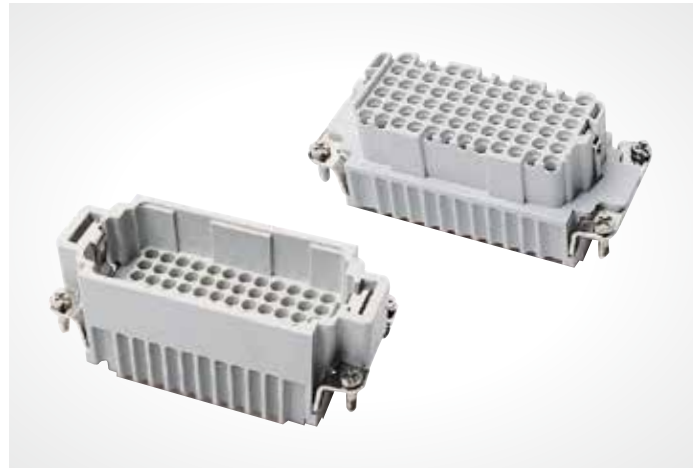

02

Crimp terminal inserts*

- Provides reliable connections for long-term configurations
- Contact sizes accommodate wiring from 12-20 AWG

* Note:

- Made of durable glass fiber-filled thermoplastic
- Contact numbers clearly marked for easy identification
- Easily installed (male or female) in either hoods or bases using captive mounting screws

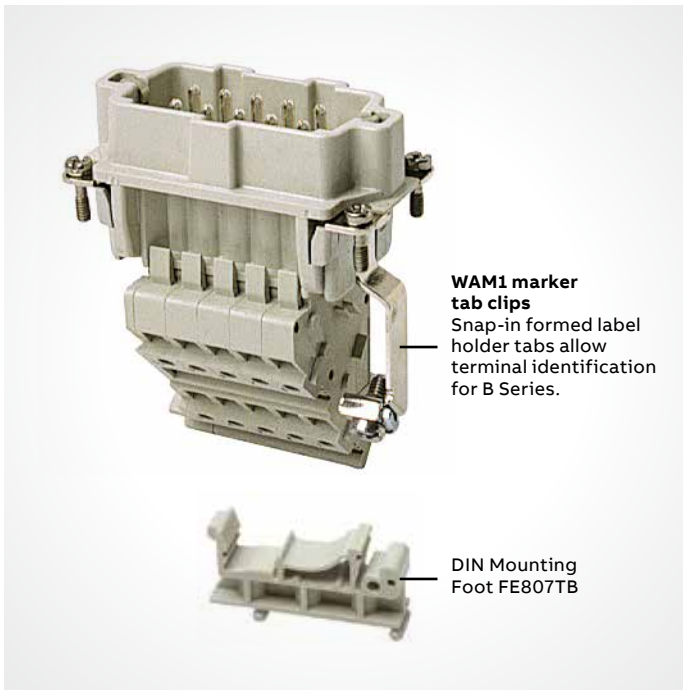

03

* Made of durable glass fiber-filled thermoplastic
 Contact numbers clearly marked for easy identification
 Easily installed (male or female) in either hoods or bases using captive mounting screws

—
 WAR, right ground strap
 WAL, left ground strap

Terminal block wiring adapters

- Allows for measuring of circuit while in operation
- Provide easy connections in panel mounting configurations
- Labels available for easy identification of circuits
- Can be mounted on DIN rails by using snap-on mounting feet
- Used in switch cabinets, panel enclosures or mounted in panel base housings – see B and D series

Insert strip blank – WAM1B
Insert strip numbers 1–64 – WAM1N64
Insert strip letters A–Z – WAM1AZ

Overview

Hood and base housings

—
01 Box base
—
02 Top cable entry
—
03 Panel base
—
04 Side cable entry
—
05 Box base housing with single lever and spring cover. Metal spring covers available for B series, where noted.

- Rugged cast aluminum hoods and bases: Maximum performance in many operating conditions
- Various hood heights available: Easier assembly and wiring with low, high and standard profiles
- Corrosion-resistant finishes: Optional special materials extend life in corrosive conditions
- Locking possibilities include single locking system and double locking system
- Complete selection: Flexible product designs (see Hood/Base cross reference below)
- Dust covers and more: See adapters (page 10) and covers (page 10) or bases with covers available in most series (accessories, pages 58–62)
- Custom configurations: Multiple conduit entry/ sizes and other configurations available to spec



01



02



03



04



05

Cross reference – Inserts

Amps	Volts	Series	A4	A10	A16	AA32	B6	B10	B16	B24	B32	B48
Series application												
Standard hood/base housing												
10	50	D	D8	–	–	–	–	–	–	–	–	–
10	600	A	A3, A4	–	–	–	–	–	–	–	–	–
16	600	A	–	A10	A16	A32	–	–	–	–	–	–
16	600	B	–	–	–	–	B6	B10	B16	B24	B32	B48
35	600	C	–	–	–	–	–	–	C6	–	C12	–
10	600	D	D7	D15	D25	D50	–	–	D40	D64	D80	D128
10	600	DD	–	–	–	–	DD24	DD42	DD72	DD108	DD144	DD216
80/16	600	K	–	–	–	–	–	–	–	K4/8	–	K8/16
Series application												
Special series hood/base housing												
16-T*	600	T	–	–	–	–	T6	T10	T16	T24	–	–
16-V**	600	V	–	–	–	–	–	V3	V6	V10	–	V32

* Special high-temperature series in copper-free aluminum with special green epoxy powder coat, Viton® seals.†

** Special isolation design allows additional control circuit capability.

† Viton is a trademark of DuPont Performance Elastomers.

Overview

- 1) Select size (number of contacts) from each series' section left-hand page chart (selected inserts), then look at corresponding right-hand page columns.
- 2) Vertical columns note single or double locking systems available (double locking usually preferable).
- 3) Select base housings for mounting and/or function: conduit/cable entry, thru-panel access, inline coupler or reversed locking as shown. (Note profile height options.)
- 4) Select side or top entry hoods as shown. (Note profile height options.)
- 5) Review conduit and cable entry options (standard NPT adapter sizes for each series).

Note: M Series (layout) groups interior options, followed by base selection options.

Each right-hand page shows:		
	Standard bases	BASE TO HOOD
	Standard hoods	
	Portable service Coupler hoods	HOOD TO COUPLER
	Reverse locking Lever hoods	BASE TO HOOD
	Post bases	

Overview

— 01 Sub-miniature (DB) adapter plates

— 02 B24 insert mounting adapter plates

— 03 Dust covers (thermoplastic) & hinged covers (thermoplastic or metal)



— 01

Sub-miniature (DB) adapter plates

- Connect test and diagnostic equipment to control circuits
- Panel base, box housing base or any hood installation (ribbon cable – entry hoods available)
- Industry standard sizes
- Dust covers for protection recommended
- 9, 15, 25, 37 and 50 series



— 02

B24 insert mounting adapter plates

- Allows housing standardization for multiple applications
- B24 footprint fit to single B6, B10, B16 inserts
- Rugged thermoplastic
- Fits standard B24 hoods and bases

B24 insert mounting adapter plates

- Allows custom connections for drill-and-install work
- Blank plate for expansion
- All standard hood/base sizes supported



— 03

Dust covers (thermoplastic) and hinged covers (thermoplastic or metal)

- Separate covers or fixed-mount hinged types
- Metal fixed-mount hinged covers for B series bases available in select sizes
- Separate or fixed covers protect contacts when not in use or while unmated
- Refer to p. 58

Overview

Wire and cable entry options



01

- 01 Cable compression seal fitting
- 02 Euro gland seal
- 03 Standard NPT conduit adapters
- 04 Cord grip fittings
- 05 Pos-E-Kon advantages



02

Portable service cord

- Sheathed industrial multi-conductor cables usage
- Options cover many installation needs
- Special constructions available for retrofit or original specification
- Hoods and bases may be specified (in bulk volumes)
- Euro standard gland seal also available
- Refer to p. 61

Cord grip fittings

- Both NPT and PG thread styles
- Thermoplastic sealing glands in NPT, PG and ISO threads – for retrofit or original specification
- More options than shown are available (shown in gray; black also available)
- Refer to p. 62

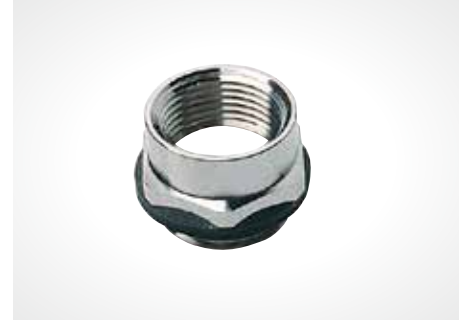

03

Standard NPT conduit adapters

- Euro PG to NPT thread adapters (PG male to NPT female)
- Standard on all Pos-E-Kon hoods and bases
- Available separately for MRO
- Sizes from PG11 to 1/2" through PG48 to 1 1/2" NPT
- Refer to p. 61

Pos-E-Kon advantages

- Feature: Ergonomic thermoplastic levers for "B" series double-lever housings B10–B24
- Benefits: Non-slip comfortable grip for easier locking and unlocking
- Feature: Laser-etched labeling for all metal housings and hot-stamped labeling on contact carrier inserts
- Benefits: Permanent marking with all data combined in external marking vs. internal label



04



05

Overview

Easy-to-use catalogue number selection

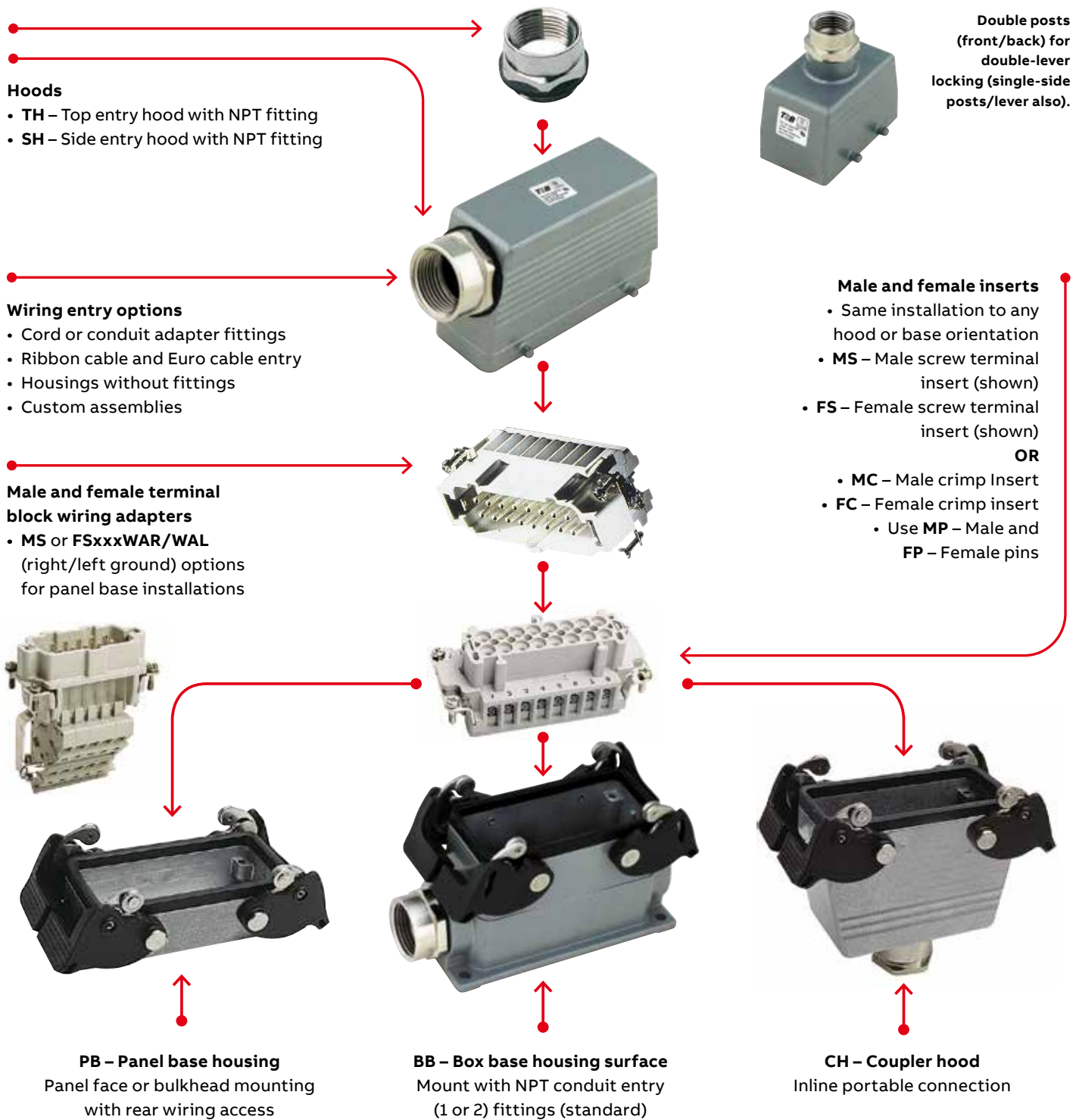

Locking

- Single lever/single posts or double lever/double posts locking
- “Reversed locking” (levers on hoods) available

Overview

Series locator

Series locator

Type	Series	Features	Contacts + G	Page
	A Series 10 A: 3, 4 16 A: All others	Small, compact size screw terminal	3, 4, 10, 16, 32	16
	B Series 16 A	Standard size screw terminal	6, 10, 16, 24, 32, 48	18
	C Series 35 A	High-current screw terminal	6 or 12	22
	D Series 10 A	High-density crimp contacts or fiber optic contacts	7, 8, 15, 25, 40, 50, 64, 80, 128	24
	DD Series 10 A	Very high-density crimp contacts	24, 42, 72, 108, 144, 216	28
	K Series 16 A/80 A	Combo, high-current/ Std. current screw terminals	16 A: 8 + 4 80 A: 16 + 8	32
	V Series 16 A	Control circuit contacts and B style screw terminals	3, 6, 20, 26, 32	34
	T Series 16 A	B Style at high-temp 200 °C screw terminals	6, 10, 16, 24	38
Reference and accessories		Specs, dimensions, components and fiber optics		40

SUSTAINABLE DEVELOPMENT

Innovation, operational excellence and sustainable development are central to everything we do, reducing our environmental footprint and improving our communities.

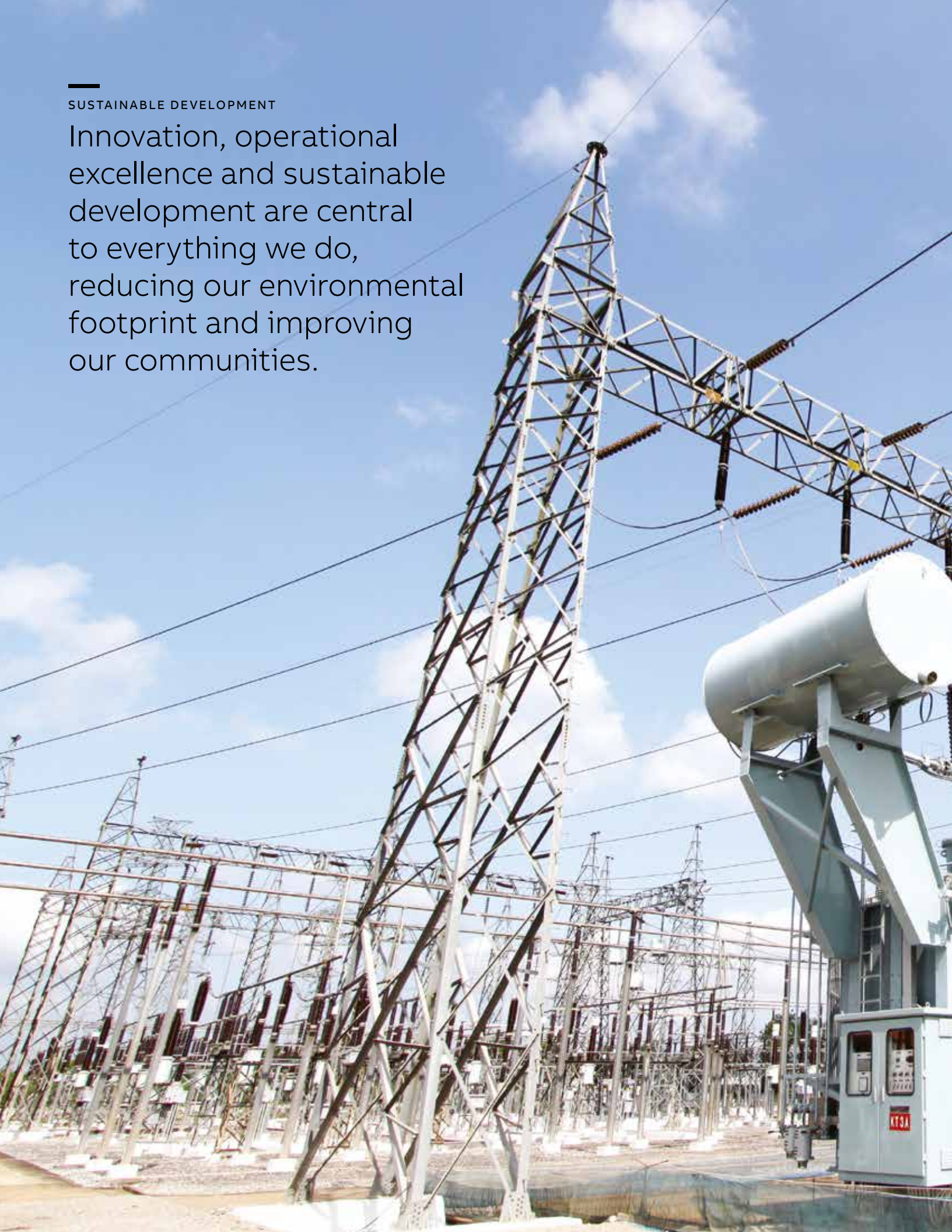



Wire pin & sleeve connectors

A Series 16 A, 600 V AC 3 or 4 contacts + ground: 10 A – 10, 16 & 32 contacts + ground: 16 A





01

Install to matching series hood/base

3 or 4 (600 V)	10	16	32

Screw terminal inserts

Screw terminal inserts	3 or 4 + G	10 + G	16 + G	32 + G
 <p>Male – pins 20–14 AWG (0.5–2.5 mm²)</p>	MS203A or MS204A (16 AWG max.)	MS210A	MS216A	MS216A+ MS232A
 <p>Female – sleeves 20–14 AWG (0.5–2.5 mm²)</p>	FS103A or FS104A (16 AWG max.)	FS110A	FS116A	FS116A+ FS132A

01 Use small blade screwdriver to push wire entry tab in for easy contact removal.

Crimp tool

Cat. no.
WT611TB



A Series 16 A, 600 V AC

Bases – standard mount		NPT entry (in.)		Number of contacts + ground connection				
				3 or 4 (600 V)	10	16	32	
Single lever	Double lever	Housing	Single		Lever locking type			
				Single	Single	Double		
		Panel base (no cover)	–	PB303A(P) [†]	PB310A	PB316A	PB132A	BASES
		Panel base (w/cover)	–	PB403A	PB410A	PB416A	–	
		Angled (no cover)	–	PB503A(P) [†]	–	–	–	
		Box base (no cover)	1 x 3/8	BB403APMV [†]	–	–	–	
			1 x 1/2	–	BB410AMV	BB416AMV	–	
			1 x 3/4	–	–	–	BB032AMV	
			1 x 1	–	–	–	BB832A	
			2 x 1/2	–	BB510AMV	BB516AMV	–	
			2 x 3/4	–	–	–	BB132AMV	
			2 x 1	–	–	–	BB132A100	
		Box base (w/cover)	1 x 1/2	–	BB610AMV	BB616AMV	–	
			2 x 1/2	–	BB710AMV	BB716AMV	–	
Hoods – standard mount *plastic body – “A” 3-16 Series standard hoods include gaskets; bases and special hoods do not.								HOODS
		Side entry	1 x 3/8	SH603APMV [†]	–	–	–	
			1 x 1/2	–	SH610AMV**	SH616AMV**	–	
			1 x 3/4	–	SH710AMV**	SH716AMV**	SH032AMV	
			1 x 1	–	–	–	SH132AMV	
		Top entry	1 x 3/8	TH803APMV [†]	–	–	–	
			1 x 1/2	–	TH810AMV**	TH816AMV**	–	
			1 x 3/4	–	TH910AMV**	TH916AMV**	TH232AMV	
			1 x 1	–	–	–	TH332AMV	
Coupler hoods – inline for inline, portable or special service connections. Coupler hoods mate to standard hoods only.								
		Top entry	1 x 3/8	CH803APMV [†]	–	–	–	
			1 x 1/2	–	CH810AMV	CH816AMV	–	
Lever hoods – reverse locking lever hoods mate to post bases only.								HOODS
		Side entry w/ lever(s)	1 x 3/4	–	–	–	LH032AMV	
			1 x 1	–	–	–	LH132AMV	
		Top entry w/ lever(s)	1 x 3/4	–	–	–	LH232AMV	
			1 x 1	–	–	–	LH332AMV	
Bases – with access cover post bases accept lever hoods only.								BASES
		Panel base + posts w/cover	–	–	–	–	PB232A	
		Box base + posts w/cover	1 x 3/4	–	–	–	BB232AMV	
			1 x 1	–	–	–	BB232A100MV	
			2 x 3/4	–	–	–	BB332A	
			2 x 1	–	–	–	BB332A100	

** Low “L” profile may be available. Contact your ABB sales representative.

[†] Indicates glass-filled thermoplastic construction, light gray color (add suffix).

* Indicates glass-filled thermoplastic construction, black color (add suffix); quantity purchase may be required.

BASE TO HOOD

HOOD TO COUPLER

BASE TO HOOD



Wire pin & sleeve connectors

B Series 16 A, 600 V AC – 6, 10 & 16 contacts + ground



01

Screw terminal inserts

	Screw terminal inserts	6 + G	10 + G	16 + G
	Male – pins 20–14 AWG (0.5–2.5 mm ²)	MS206B	MS210B	MS216B
	Female – sleeves 20–14 AWG (0.5–2.5 mm ²)	FS106B	FS110B	FS116B

Screw terminal wiring adapter blocks

	Screw terminal inserts	6 + G	10 + G	16 + G
	Female insert, ground L. 20–14 AWG (0.5–2.5 mm ²)	FS106WAL	FS110WAL	FS116WAL

01 Use small blade screwdriver to push wire entry tab in for easy contact removal.

Crimp tool

	Cat. no.
	WT611TB

Install to matching series hood/base



Accessories

Cat. no.	Description
WAM-1	Label insert clip
WAM1B	Strip blank
WAM1N64	Strip nos. 1–64
WAM1AZ	Strip letters A–Z

Wiring adapter insert for use with panel bases; allows single access direction panel-build wiring and easy terminal ID for service and testing.

B Series 16 A, 600 V AC

Bases – standard mount				Number of contacts + ground connection					
				6		10		16	
Single lever	Double lever	Housing	NPT entry (in.)		Single	Double	Lever locking type		
			Single	Double			Single	Double	
		Panel base (no cover)	-	PB306**	PB310	PB110E	PB316**	PB116E	
		Panel base (w/cover)	-	PB406**	PB410**	-	PB416**	-	
		Box base (no cover)	1 x ½	BB406MV	BB410MV	BB010EMV	-	-	
			1 x ¾	BB406MVH075	BB410MVH075	BB010MVEH075	BB416MV*	BB016EMV*	
		1 x 1	BB406H100MV	BB410MVH100	BB010EH100MV	BB416H100MV	BB016EH100MV		
		2 x ½	BB506MV	BB510MV	BB110EMV	-	-		
		2 x ¾	BB506H075MV	BB510H075MV	BB110EH075MV	BB516MV*	BB116EMV*		
		Box base (w/cover)	1 x ½	BB606MV**	BB610MV**	-	-		
			1 x ¾	BB606H075MV**	BB610H075MV**	-	BB616MV* **		
		1 x 1	BB606H100**	BB610H100MV**	-	BB616MVH100**			
		2 x ½	BB706MV**	BB710MV**	-	-			
		2 x ¾	BB706H075**	BB710H075MV**	-	BB716MV* **			
		2 x 1	BB706H100**	BB710H100MV**	-	BB716H100MV**			
Hoods – standard mount *plastic body – “B” 3-16 Series standard hoods include gaskets; bases and special hoods do not.									
		Side entry	1 x ½	SH606MV	SH610MV	SH010MV	-	-	
		1 x ¾	SH606H075MV	SH610H075MV	SH010H075MV	SH616MV†	SH016MV†		
		1 x 1	SH606H100MV	SH610H100MV	SH010H100MV	SH716HMV†	SH116HMV		
		Top entry	1 x ½	TH806MV	TH810MV	TH210MV	-	-	
		1 x ¾	TH806H075MV	TH810H075MV	TH210H075MV	TH816MV†	TH216MV†		
		1 x 1	TH806H100MV	TH810H100MV	TH210H100MV	TH816H100MV	TH316HMV		
Coupler hoods – inline for inline, portable or special service connections. Coupler hoods mate to standard hoods only.									
		Top entry	1 x ½	CH806HMV	CH810EMV	CH610E	-	-	
		1 x ¾	CH806H075MV	CH810H075MV	CH610EH075MV	CH816HMV	CH616EHMV		
		1 x 1	CH806H100MV	CH810H100MV	CH610EH100MV	CH916HMV	CH716EHMV		
Lever hoods – reverse locking lever hoods mate to post bases only.									
		Side entry w/lever(s)	1 x ½	-	-	LH010EMV	-	-	
		1 x ¾	-	-	LH010EH075MV	-	LH016EMV*		
		1 x ¾	-	-	LH010EH100MV	-	LH116EHMV		
		Top entry w/lever(s)	1 x ½	-	-	LH210EMV	-	-	
		1 x ¾	-	-	LH210EH075MV	-	LH216E*		
		1 x 1	-	-	LH210EH100MV	-	LH316EHMV		
Bases – with access cover post bases accept lever hoods only.									
		Panel base + posts w/cover	-	-	-	PB210**	-	PB216**	
			Box base + posts w/cover	1 x ½	-	-	BB210MV**	-	-
				1 x ¾	-	-	BB210H075MV**	-	BB216MV* **
				1 x 1	-	-	BB210H100MV**	-	BB216H100MV**
				2 x ½	-	-	BB310MV**	-	-
				2 x ¾	-	-	BB310H075MV**	-	BB316MV**
2 x 1	-			-	BB310H100MV**	-	BB316H100MV**		

* High “H” profile may be available. Contact your ABB sales representative.

** Metal “M” cover may be available. Contact your ABB sales representative.

† High “H” and Low “L” profile may be available. Contact your ABB sales representative.

BASES
BASE TO HOOD

HOODS
HOOD TO COUPLER

HOODS
BASE TO HOOD

HOODS

COUPLER

BASES

Wire pin & sleeve connectors

B Series 16 A, 600 V AC – 24, 32 & 48 contacts + ground





01

Screw terminal inserts

Install to matching series hood/base





	Screw terminal inserts	24 + G	32 + G	48 + G
	Male – Pins 20–14 AWG (0.5–6 mm ²)	MS224B	MS216B (1-16) + MS232B (17-32)	MS224B (1-24) + MS248B (25-48)
	Female – Sleeves 20–14 AWG (0.5–6 mm ²)	FS124B	FS116B (1-16) + FS132B (17-32)	FS124B (1-24) + FS148B (25-48)

Screw terminal wiring adapter blocks

	Screw terminal inserts	24 + G	32 + G	48 + G
	Female insert, ground L 20–14 AWG (0.5–2.5 mm ²)	FS124WAL	–	–

Screw terminal inserts

	Crimp terminal inserts	24 + G	32 + G	48 + G
	Male insert	MC424B	MC416B (1-16) + MC432B (17-32)	MC424B (1-24) + MC448B (25-48)
	Female insert	FC324B	FC316B (1-16) + FC332B (17-32)	FC324B (1-24) + FC348B (25-48)

01 Use small blade screwdriver to push wire entry tab in for easy contact removal.

Crimp tool



Accessories

Cat. no.	Description
WAM-1	Label insert clip
WAM1B	Strip blank
WAM1N64	Strip nos. 1–64
WAM1AZ	Strip letters A–Z

Wiring adapter insert for use with panel bases; allows single access direction panel-build wiring and easy terminal ID for service and testing.

B Series 16 A, 600 V AC

Bases – standard mount				Number of contacts + ground connection			
				24		32	
Single lever	Double lever	Housing	NPT entry (in)	Lever locking type			
				Single	Double	Double	Single
		Panel base (no cover)	-	PB324	PB124E	PB132	PB348
		Panel base w/cover	-	PB424†	-	-	PB448
		Box base (no cover)	1 x ¾	BB424MV*	BB024EMV*	-	-
			1 x 1	BB424H100MV	BB024EH100MV	BB032MV	BB448MV
			2 x ¾	BB524MV*	BB124EMV*	-	-
			2 x 1	BB524H100MV	BB124EH100MV	BB132MV	BB548MV
		Box base w/cover	1 x ¾	BB624MV*†	-	-	-
			1 x 1	BB624H100MV†	-	-	BB648MV
			2 x ¾	BB724MV*†	-	-	-
			2 x 1	BB724H100MV†	-	-	BB748MV
Hoods – standard mount plastic body – “A” 3-16 series standard hoods include gaskets; Bases and special hoods do not							
		Side entry	1 x ¾	SH624MV**	SH024MV**	SH032MV	-
			1 x 1	SH724MV**	SH124MV**	SH132MV	SH648MV
			1 x 1¼	-	-	SH132125MV	SH748MV
		Top entry	1 x ¾	TH824MV**	TH224MV**	TH232MV	-
			1 x 1	TH924MV**	TH324MV**	TH332MV	TH848MV
			1 x 1¼	-	-	TH332125MV	TH948MV
			Ribbon CBL	-	TH424RCMV	-	-
Coupler hoods – inline – For inline, portable or special service connections. Coupler hoods mate to standard hoods ONLY							
		Top entry	1 x ¾	CH824MV	CH624EMV	CH632MV	-
			1 x 1	CH924MV	CH724EMV	CH732MV	-
			Ribbon CBL	-	CH724ERC MV	-	-
Lever hoods – reverse locking – Lever hoods mate to post bases ONLY							
		Side entry w/lever(s)	1 x ¾	-	LH024EMV	-	-
			1 x 1	-	LH124EMV	-	-
		Top entry w/lever(s)	1 x ¾	-	LH224E	-	-
			1 x 1	-	LH324EMV	-	-
Bases – with access cover post bases accept lever hoods ONLY							
		Panel base w/posts + cover	-	-	PB224†	-	-
		Box base w/posts + cover	1 x ¾	-	BB224MV*†	-	-
			1 x 1	-	BB224H100MV	-	-
			2 x ¾	-	BB324MV*†	-	-
			2 x 1	-	BB324H100MV	-	-

* High “H” profile may be available. Contact your ABB sales representative.
 ** Low “L” profile may be available. Contact your ABB sales representative.
 † Metal “M” cover may be available. Contact your ABB sales representative.

BASE TO HOOD

HOOD TO COUPLER

BASE TO HOOD



Wire pin & sleeve connectors

C Series 35 A, 600 V AC – 6 or 12 contacts + ground

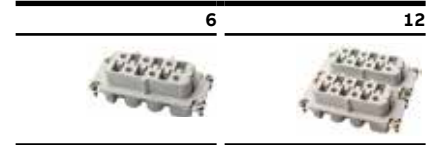













Install to matching series hood/base



Screw terminal contact carrier connection blocks

	Screw terminal inserts	6 + G	12 + G
	Male – Pins 20–10 AWG (0.5–6 mm ²)	MS206C	MS206C (1–6) + MS212C (7–12)
	Female – Sleeves 20–10 AWG (0.5–6 mm ²)	FS106C	FS106C (1–6) + FS112C (7–12)

C Series 35 A, 600 V AC

			Number of contacts + ground connection			
Bases – standard mount					6	12
Single lever	Double lever	Housing	NPT entry (in.)	Single	Double	Lever locking type
						Double
		Panel base (no cover)	-	PB316	PB116E	PB132
		Panel base (w/cover)	-	PB416	-	-
		Box base (no cover)	1 x ¾	BB416MV*	BB016EMV*	-
			1 x 1	BB416H100MV	BB016EH100MV	BB032MV
			2 x ¾	BB516MV*	BB116EMV*	-
			2 x 1	BB516H100MV	BB116EH100MV	BB132MV
		Box base (w/cover)	1 x ½	BB616MV**	-	-
			1 x 1	BB616H100MV†	-	-
			2 x ½	BB716MV**	-	-
			2 x 1	BB716H100MV†	-	-
Hoods – standard mount						
		Side entry	1 x ¾	SH616MV‡	SH016MV‡	SH032MV
			1 x 1	SH716H100MV	SH116H100MV	SH132MV
			1 x 1½	-	-	SH132125MV
		Top entry	1 x ¾	TH816MV‡	TH216MV‡	TH232MV
			1 x 1	TH816H100MV	TH316H100MV	TH332MV
			1 x 1½	-	-	TH332125MV
Coupler hoods – inline for inline, portable or special service connections. Coupler hoods mate to standard hoods only.						
		Top entry	1 x ¾	CH816H100MV	CH616EH100MV	CH632MV
			1 x 1	CH916H100MV	CH716EH100MV	CH732MV
Lever hoods – reverse locking lever hoods mate to post bases only.						
		Side entry w/lever(s)	1 x ¾	-	LH016EMV*	-
			1 x 1	-	LH116EHMV	-
		Top entry w/lever(s)	1 x ¾	-	LH216E*	-
			1 x 1	-	LH316EHMV	-
Bases – with access cover post bases accept lever hoods only.						
		Panel base + posts w/cover	-	-	PB216†	-
		Box base + posts w/cover	1 x ¾	-	BB216MV**	-
			1 x 1	-	BB216H100MV†	-
			2 x ¾	-	BB316MV**	-
			2 x 1	-	BB316H100MV†	-

* High "H" profile may be available. Contact your ABB sales representative.

** Low "L" profile may be available. Contact your ABB sales representative.

† Metal "M" cover may be available. Contact your ABB sales representative.

‡ High "H" and Low "L" profile may be available. Contact your ABB sales representative.

Wire pin & sleeve connectors

D Series 10 A, 600 V AC – 7 or 8, 15, 25 & 40 contacts + ground

Install to matching series hood/base



Crimp terminal inserts

Crimp terminal inserts	7 or 8 + G	15 + G	25 + G	40 + G
 Male insert (Order contacts below)	MC407D or MC408D	MC415D	MC425D	MC440D
 Female insert (Order contacts below)	FC307D or FC308D	FC315D	FC325D	FC340D

Contacts sold separately

Screw terminal wiring adapter blocks

Screw terminal wiring adapter blocks				40 + G
 Male insert, ground L. 26–16 AWG (0.2–1.5 mm ²)	-	-	-	MS440WAL
 Female insert, ground L. 26–16 AWG (0.2–1.5 mm ²)	-	-	-	FS340WAL

Contacts selection chart for all crimp terminal “D” inserts

Crimp contacts	Wire AWG (mm ²)	Identification	Female	Male
 I.D.	22+ AWG (0.14–0.37)	1	FP22SD	MP22SD
	20 AWG (0.5)	2	FP20SD	MP20SD
	18 AWG (0.75–1)	3	FP18SD	MP18SD
	16 AWG (1.5)	4	FP16SD	MP16SD
	14 AWG (2.5)	5	FP14SD	MP14SD

For optic contacts

Crimp contacts	Wire AWG (mm ²)	Identification	Female	Male
 I.D.	18 AWG (0.75–1)	3	FP18SD	MP18SD

See page 63 for POF installation and tools info.

Accessories

Cat. no.	Description
WAM-1	Label insert clip
WAM1B	Strip blank
WAM1N64	Strip nos. 1–64
WAM1AZ	Strip letters A–Z

Wiring adapter insert for use with panel bases; allows single access direction panel-build wiring and easy terminal ID for service and testing.

Crimp tool

Cat. no.
 WT80

Extraction tool

Cat. no.
 RT614

D Series 10 A, 600 V AC

Bases – standard mount		Number of contacts + ground connection							
		7 or 8		15	25	40			
Single lever	Double lever	Housing	NPT entry (in.)		Lever locking type				
			Single	Double	Single	Double	Single	Double	
		Panel base (no cover)	-	PB303A(P)**	PB310A	-	-	PB316	PB116E
		Panel base (w/cover)	-	PB403A	PB410A	PB316A	-	PB416	-
		Angled (no cover)	-	PB503A(P)**	PB416A	-	-	-	-
		Box base (no cover)	1 x 3/8	BB403APMV**	-	-	-	-	-
			1 x 1/2	-	BB410AMV	BB416AMV	-	-	-
			2 x 1/2	-	BB510AMV	BB516AMV	-	-	-
			1 x 3/4	-	-	-	-	BB416MV*	BB016EMV*
			1 x 1	-	-	-	-	BB416H100MV	BB016EH100MV
			2 x 3/4	-	-	-	-	BB516MV*	BB116EMV*
			2 x 1	-	-	-	-	BB516H100MV	BB116EH100MV
		Box base (w/cover)	1 x 1/2	-	BB610AMV	BB616AMV	-	-	
			1 x 3/4	-	BB710AMV	BB716AMV	-	-	
			1 x 1	-	-	-	-	BB616MV*†	-
			2 x 1/2	-	-	-	-	BB616H100MV†	-
			2 x 3/4	-	-	-	-	BB716MV*†	-
			2 x 1	-	-	-	-	BB716H100MV†	-
Hoods – standard mount *plastic body – “A” 3-16 series standard hoods include gaskets; bases and special hoods do not.									
		Side entry	1 x 3/8	SH603APMV**	-	-	-	-	
			1 x 1/2	-	SH610AMV	SH616AMV	-	-	
			1 x 3/4	-	SH710AMV	SH716AMV	SH616MV†	SH016MV†	
			1 x 1	-	-	-	SH716H100MV†	SH116H100MV	
		Top entry	1 x 3/8	TH803APMV**	-	-	-	-	
			1 x 1/2	-	TH810AMV	TH816AMV	-	-	
			1 x 3/4	-	TH910AMV	TH916AMV	TH816MV†	TH216MV†	
			1 x 1	-	-	-	TH816H100MV	TH316H100MV	
Coupler hoods – inline for inline, portable or special service connections. Coupler hoods mate to standard hoods only.									
		Top entry	1 x 3/8	CH803APMV**	-	-	-	-	
			1 x 1/2	-	CH810AMV	CH816AMV	-	-	
			1 x 3/4	-	-	-	CH816H100MV	CH616EH100MV	
			1 x 1	-	-	-	CH916H100MV	CH716EH100MV	
Lever hoods – reverse locking lever hoods mate to post bases only.									
		Side entry w/lever(s)	1 x 3/4	-	-	-	-	LH016EMV*	
			1 x 1	-	-	-	-	LH116EHMV	
		Top entry w/lever(s)	1 x 3/4	-	-	-	-	LH216E*	
			1 x 1	-	-	-	-	LH316EHMV	
Bases – with access cover post bases accept lever hoods only.									
		Panel base + posts w/cover	-	-	-	-	-	PB216†	
		Box base + posts w/cover	1 x 3/4	-	-	-	-	BB216MV*†	
			1 x 1	-	-	-	-	BB216H100MV†	
			2 x 3/4	-	-	-	-	BB316MV*†	
2 x 1	-		-	-	-	BB316H100MV†			

* High “H” profile may be available. Contact your ABB sales representative.

** Indicates glass-filled thermoplastic construction.

† Metal “M” cover may be available. Contact your ABB sales representative.

‡ High “H” and Low “L” profile may be available. Contact your ABB sales representative.

BASES

BASE TO HOOD

HOODS

HOOD TO COUPLER

COUPLER

HOODS

BASE TO HOOD

BASES



Wire pin & sleeve connectors

D Series 10 A, 600 V AC – 50, 64, 80 & 128 contacts + ground

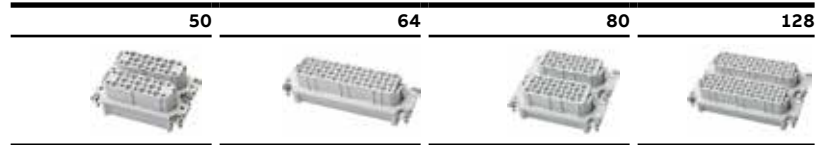
Install to matching series hood/base







Crimp terminal inserts

	Crimp terminal inserts	50 + G	64 + G	80 + G	128 + G
	Male insert (Order contacts below)	MC425D (2x)	MC464D	MC440D (2x)	MC464D (2x)
	Female insert (Order contacts below)	FC325D (2x)	FC364D	FC340D (2x)	FC364D (2x)

Contacts sold separately

Contacts selection chart for all crimp terminal “D” inserts

Crimp contacts	Wire AWG (mm ²)	Identification	Female	Male
	22+ AWG (0.14–0.37)	1	FP22SD	MP22SD
	20 AWG (0.5)	2	FP20SD	MP20SD
	18 AWG (0.75–1)	3	FP18SD	MP18SD
	16 AWG (1.5)	4	FP16SD	MP16SD
	14 AWG (2.5)	5	FP14SD	MP14SD

Accessories

Cat. no.	Description
MP22SD	Label insert clip
MP20SD	Strip blank
MP18SD	Strip nos. 1–64
MP16SD	Strip letters A–Z
Wiring adapter insert for use with panel bases; allows single access direction panel-build wiring and easy terminal ID for service and testing.	

For optic contacts

Crimp contacts	Wire AWG (mm ²)	Identification	Female	Male
	18 AWG (0.75–1)	3	FP18SD	MP18SD

See page 63 for POF installation and tools info.

Crimp tool

Cat. no.
WT80



Extraction tool

Cat. no.
RT614



D Series 10 A, 600 V AC

Bases – standard mount		NPT entry (in.)		Number of contacts + ground connection					
				50	64	16		32	
Single lever	Double lever	Housing	NPT entry (in.)		Lever locking type				
			Double	Single	Double	Double	Single	Single	
		Panel base (no cover)	-	PB132A	PB324	PB124E	PB132	PB348	BASES
		Panel base (w/cover)	-	-	PB424	-	-	-	
		Box base (no cover)	1 x ¾	BB032AMV	BB424MV*	BB024EMV*	-	-	BASES
			1 x 1	BB832AMV	BB424H100MV	BB024EH100MV	BB032MV	BB448MV	
			2 x ¾	BB132AMV	BB524MV*	BB124EMV*	-	-	
			2 x 1	BB132A100	BB524H100MV	BB124EH100MV	BB132MV	BB548MV	
		Box base (w/cover)	1 x ¾	-	BB642**	-	-	-	BASES
			1 x 1	-	BB642H100†	-	-	BB648MV	
			2 x ¾	-	BB724MV**	-	-	-	
			2 x 1	-	BB724H100MV†	-	-	BB748MV	
Hoods – standard mount *plastic body – “A” 3-16 series standard hoods include gaskets; bases and special hoods do not.									
		Side entry	1 X ¾	SH032AMV	SH624MV**	SH024MV**	SH032MV	-	HOODS
			1 X 1	SH132AMV	SH724MV**	SH124MV**	SH132MV	SH648MV	
			1 X 1¼	-	-	-	-	SH748MV	
		Top entry	1 x ¾	TH232AMV	TH824MV**	TH224MV**	TH232MV	-	HOODS
			1 x 1	TH332AMV	TH924MV	TH324MV	TH332MV	TH848MV	
			1 X 1¼	-	-	-	-	TH948	
			Ribbon CBL	-	TH624RC	TH424RC	-	-	
Coupler hoods – inline for inline, portable or special service connections. Coupler hoods mate to standard hoods only.									
		Top entry	1 x ¾	-	CH824MV	CH624EMV	CH632MV	-	COUPLER
			1 x 1	-	CH924MV	CH724EMV	CH732MV	-	
			Ribbon CBL	-	-	CH724ERC MV	-	-	
Lever hoods – reverse locking lever hoods mate to post bases only.									
		Side entry w/lever(s)	1 x ¾	LH032AMV	-	LH024EMV	-	-	HOODS
			1 x 1	LH132AMV	-	LH124EMV	-	-	
		Top entry w/lever(s)	1 x ¾	LH232AMV	-	LH224E	-	-	HOODS
			1 x 1	LH332AMV	-	LH324EMV	-	-	
Bases – with access cover post bases accept lever hoods only.									
		Panel base + posts w/cover	-	PB232A	-	PB224†	-	-	BASES
		Box base + posts w/cover	1 x ¾	BB232AMV	-	BB224MV**	-	-	
			1 x 1	BB232A100MV	-	BB224H100MV	-	-	
			2 x ¾	BB332A	-	BB324MV**	-	-	
			2 x 1	BB332A100	-	BB324H100MV	-	-	

* High “H” profile may be available. Contact your ABB sales representative.

** Low “L” profile may be available. Contact your ABB sales representative.

† Metal “M” cover may be available. Contact your ABB sales representative.

Wire pin & sleeve connectors

DD Series 10 A, 600 V AC – 24, 42 & 72 contacts + ground

Install to matching series hood/base



Crimp terminal inserts

	Screw terminal inserts	24 + G	42 + G	72 + G
	Male insert (Order contacts below)	MC224DD	MC242DD	MC272DD
	Female insert (Order contacts below)	FC124DD	FC142DD	FC172DD

Contacts selection chart for all crimp terminal “DD” inserts

Crimp contacts	Wire AWG (mm ²)	Identification	Female	Male
	22+ AWG (0.14–0.37)	1	FP22SD	MP22SD
	20 AWG (0.5)	2	FP20SD	MP20SD
	18 AWG (0.75–1)	3	FP18SD	MP18SD
	16 AWG (1.5)	4	FP16SD	MP16SD
	14 AWG (2.5)	5	FP14SD	MP14SD

See page 63 for POF installation and tools info.

Crimp tool

	Cat. no.
	WT80

Extraction tool

	Cat. no.
	RT614

DD Series 10 A, 600 V AC

Bases – standard mount				Number of contacts + ground connection					
				24		42		72	
Single lever	Double lever	Housing entry (in.)	NPT		Lever locking type				
			Single	Double	Single	Double			
		Panel base (no cover)	–	PB306**	PB310**	PB110E	PB316	PB116E	BASES
		Panel base (w/cover)	–	PB406**	PB410**	–	PB416	–	
		Box base (no cover)	1 x ½	BB406MV	BB410MV	BB010EMV	–	–	
			1 x ¾	BB406MVH075	BB410H075MV	BB010EH075MV	BB416MV*	BB016EMV*	
			1 x 1	BB406H100MV	BB410H100MV	BB010EH100MV	BB416H100MV	BB016EH100MV	
			2 x ½	BB506MV	BB510MV	BB110EMV	–	–	
			2 x ¾	BB506H075MV	BB510H075MV	BB110EH075MV	BB516MV*	BB116EMV*	
		2 x 1	BB506H100	BB510H100	BB110EH100MV	BB516H100MV	BB116EH100MV		
		Box base	1 x ½	BB606MV**	BB610MV**	–	–	–	
			1 x ¾	BB606H075MV**	BB610H075MV**	–	BB616MV* **	–	
			1 x 1	BB606H100**	BB610H100MV**	–	BB616H100MV**	–	
			2 x ½	BB706MV**	BB710MV**	–	–	–	
			2 x ¾	BB706H075**	BB710H075MV**	–	BB716MV* **	–	
			2 x 1	BB706H100**	BB710H100MV**	–	BB716H100MV**	–	
Hoods – standard mount									
		Side entry	1 x ½	SH606MV	SH610MV	SH010MV	–	–	HOODS
			1 x ¾	SH606H075MV	SH610H075MV	SH010H075MV	SH616MV†	SH016MV†	
			1 x 1	SH606H100MV	SH610H100MV	SH010H100MV	SH716H100MV†	SH116H100MV	
		Top entry	1 x ½	TH806MV	TH810MV	TH210MV	–	–	HOODS
			1 x ¾	TH806H075MV	TH810H075MV	TH210H075MV	TH816MV†	TH216MV†	
			1 x 1	TH806H100MV	TH810H100MV	TH210H100MV	TH816H100MV	TH316H100MV	
Coupler hoods – inline for inline, portable or special service connections. Coupler hoods mate to standard hoods only.									
		Top entry w/leveler(s)	1 x ½	CH806	CH810	CH610E	–	–	COUPLER
			1 x ¾	CH806H075MV	CH810H075MV	CH610EH075MV	CH816H100MV	CH616EH100MV	
			1 x 1	CH806H100MV	CH810H100MV	CH610EH100MV	CH916H100MV	CH716EH100MV	
Lever hoods – reverse locking lever hoods mate to post bases only.									
		Side entry w/lever(s)	1 x ½	–	–	LH010EMV	–	–	HOODS
			1 x ¾	–	–	LH010EH075MV	–	LH016EMV*	
			1 x 1	–	–	LH010EH100MV	–	LH116EHMV	
		Top entry w/lever(s)	1 x ½	–	–	LH210EMV	–	–	HOODS
			1 x ¾	–	–	LH210EH075MV	–	LH216E*	
			1 x 1	–	–	LH210EH100MV	–	LH316EHMV	
Bases – with access cover post bases accept lever hoods only.									
		Panel + posts w/cover	–	–	–	PB210**	–	PB216**	BASES
		Box + posts w/cover	1 x ½	–	–	BB210MV**	–	–	
			1 x ¾	–	–	BB210H075MV**	–	BB216MV* **	
			1 x 1	–	–	BB210H100MV**	–	BB216H100MV**	
			2 x ½	–	–	BB310MV**	–	–	
			2 x ¾	–	–	BB310H075MV**	–	BB316MV* **	
			2 x 1	–	–	BB310H100MV**	–	BB316H100MV**	

* High "H" profile may be available. Contact your ABB sales representative.

** Metal "M" cover may be available. Contact your ABB sales representative.

† High "H" and Low "L" profile may be available. Contact your ABB sales representative.



Wire pin & sleeve connectors

DD Series 10 A, 600 V AC – 108, 144 & 216 contacts + ground

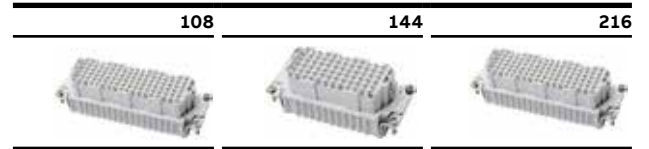
Install to matching series hood/base



Crimp terminal inserts

	Crimp terminal inserts	108 + G	144 + G	216 + G
	Male insert (Order contacts below)	MC208DD	MC272DD+ MC244DD	MC208DD+ MC216DD
	Female insert (Order contacts below)	FC108DD	FC172DD+ FC144DD	FC108DD+ FC116DD

Contacts selection for all crimp terminal “DD” inserts

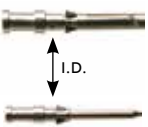
Crimp contacts	Wire gauge AWG (mm ²)	Identification	Female	Male
	22+ AWG (0.14–0.37)	1	FP22SD	MP22SD
	20 AWG (0.5)	2	FP20SD	MP20SD
	18 AWG (0.75–1)	3	FP18SD	MP18SD
	16 AWG (1.5)	4	FP16SD	MP16SD
	14 AWG (2.5)	5	FP14SD	MP14SD

See page 63 for POF installation and tools info.













Crimp tool

	Cat. no.
	WT80

Extraction tool

	Cat. no.
	RT614

DD Series 10 A, 600 V AC

			Number of contacts + ground connection					
Bases – standard mount			108	144	216			
Single lever	Double lever	Housing	NPT entry (in.)	Lever locking type				
				Single	Double	Double	Single	
		Panel base (no cover)	-	PB324	PB124E	PB132	PB348	
		Panel base (w/cover)	-	PB424 [†]	-	-	PB448	
		Box base (no cover)	1 x ¾	BB424MV*	BB024EMV*	-	-	
			1 x 1	BB424H100MV	BB024EH100MV	BB032MV	BB448MV	
			2 x ¾	BB524MV*	BB124EMV*	-	-	
			2 x 1	BB524H100MV	BB124EH100MV	BB132MV	BB548MV	
		Box base (w/cover)	1 x ¾	BB624MV** [†]	-	-	-	
			1 x 1	BB624H100MV [†]	-	-	BB648MV	
			2 x ¾	BB724MV** [†]	-	-	-	
			2 x 1	BB724H100MV [†]	-	-	BB748MV	
Hoods – standard mount								
		Side entry	1 x ¾	SH624MV**	SH024MV**	SH032MV	-	
			1 x 1	SH724MV**	SH124MV**	SH132MV	SH648MV	
			1 x 1 ¼	-	-	SH132125MV	SH748MV	
		Top entry	1 x ¾	TH824MV**	TH224MV**	TH232MV	-	
			1 x 1	TH924MV**	TH324MV**	TH332MV	TH848MV	
			1 x 1 ¼	-	-	TH332125MV	TH948MV	
Coupler hoods – inline for inline, portable or special service connections. Coupler hoods mate to standard hoods only.								
		Top entry	1 x ¾	CH824MV	CH624EMV	CH632MV	-	
			1 x 1	CH924MV	CH724EMV	CH732MV	-	
Lever hoods – reverse locking lever hoods mate to post bases only.								
		Side entry w/lever(s)	1 x ¾	-	LH024EMV	-	-	
			1 x 1	-	LH124EMV	-	-	
		Top entry w/lever(s)	1 x ¾	-	LH224E	-	-	
			1 x 1	-	LH324EMV	-	-	
Bases – with access cover post bases accept lever hoods only.								
		Panel base w/posts + cover	-	-	PB224 [†]	-	-	
			Box base w/posts + cover	1 x ¾	-	BB224MV** [†]	-	-
				1 x 1	-	BB224H100MV	-	-
				2 x ¾	-	BB324MV** [†]	-	-
			2 x 1	-	BB324H100MV	-	-	

* High "H" profile may be available. Contact your ABB sales representative.
 ** Low "L" profile may be available. Contact your ABB sales representative.
[†] Metal "M" cover may be available. Contact your ABB sales representative.

Wire pin & sleeve connectors



K Series 80 + 16 A, 600 V AC – 4 @ 80A + 8 @ 16A, 8 @ 80A + 16 @ 16A contacts + ground

Install to matching series hood/base

4 @ 80 A + 8 @ 16 A + G	8 @ 80 A + 16 @ 16 A + G
-------------------------	--------------------------

















Screw terminal contact carrier inserts

Screw terminal contact carrier inserts	4 @ 80 A+8 @ 16 A+G	8 @ 80 A+16 @ 16 A+G
 Male – Pins	MS212K	MS212K (x2)
 Female – Sleeves	FS112K	FS112K (x2)

Wiring note: To #6 AWG (16 mm²) 80 A contacts and to #14 AWG (2.5 mm²) 16 A contacts.

K Series 80 + 16 A, 600 V AC

				Number of contacts + ground connection		
				K-12	K-24	
Bases – standard mount				4 @ 80 A + 8 @ 16 A + G	8 @ 80 A + 16 @ 16 A + G	
Single lever	Double lever	Housing	NPT entry (in.)	Single	Double	Single
				Lever locking type		
		Panel base (no cover)	–	PB324	PB124E	PB348
		Panel base (w/cover)	–	PB424	–	–
		Box base (no cover)	1 x ¾	BB424MV*	BB024EMV	–
			1 x 1	BB424H100MV	BB024EH100MV	BB448MV
			2 x ¾	BB524MV*	BB124EMV*	–
			2 x 1	BB524H100MV	BB124EH100MV	BB548MV
		Box base (w/cover)	1 x ¾	BB624MV†	–	–
			1 x 1	BB624H100MV†	–	BB648MV
			2 x ¾	BB724MV*‡	–	–
			2 x 1	BB724H100MV†	–	BB748MV
Hoods – standard mount *plastic body – “A” 3-16 Series standard hoods include gaskets; bases and special hoods do not.						
		Side entry	1 x ¾	SH624MV**	SH024MV**	–
			1 x 1	SH724MV**	SH124MV**	SH648MV
			1 x 1½	–	–	SH748MV
		Top entry	1 x ¾	TH824MV**	TH224MV**	–
			1 x 1	TH924MV	TH324MV	TH848MV
			1 x 1½	–	–	TH948MV
Coupler hoods – inline for inline, portable or special service connections. Coupler hoods mate to standard hoods only.						
		Top entry	1 x ¾	CH824MV	CH624EMV	–
			1 x 1	CH924MV	CH724EMV	–
Lever hoods – reverse locking lever hoods mate to post bases only.						
		Side entry w/lever(s)	1 x ¾	–	LH032AMV	–
			1 x 1	–	LH132AMV	–
		Top entry w/lever(s)	1 x ¾	–	LH232AMV	–
			1 x 1	–	LH332AMV	–
Bases – with access cover post bases accept lever hoods only.						
		Panel base + posts w/cover	–	–	PB224†	–
		Box base + posts w/cover	1 x ¾	–	BB224MV*‡	–
			2 x ¾	–	BB324MV*‡	–

* High “H” profile may be available. Contact your ABB sales representative.

** Low “L” profile may be available. Contact your ABB sales representative.

† Metal “M” cover may be available. Contact your ABB sales representative.

Wire pin & sleeve connectors

V Series 16 A, 600 V AC – 3 & 6 contacts + control contacts & ground



01

Install to matching series hood/base



Screw terminal inserts





	Screw terminal inserts (mm ²)	3 + G + 2 control	6 + G + 2 control
	Male - Pins 20-14 AWG (0.5-2.5)	MS203V	MS206V
	Female - Sleeves 20-14 AWG (0.5-2.5)	FS103V	FS106V

01 Use small blade screwdriver to push wire entry tab in for easy contact removal.

Crimp tool



V Series 16 A, 600 V AC

Hoods – standard mount			Number of contacts + ground connection				
			3 + G + 2 control		6 + G + 2 control		
Single lever	Double lever	Housing	NPT entry (in.)	Lever locking type		Single	Double
				Single	Double		
		Side entry	1 x ½	SH603V	SH003V	-	-
			1 x ¾	-	-	SH606VMV	SH006V
		Top entry	1 x ½	TH803VMV	TH203V	-	-
			1 x ¾	-	-	TH806VMV	TH206V

HOODS

* Metal "M" cover may be available. Contact your ABB sales representative.

Wire pin & sleeve connectors

V Series 16 A, 600 V AC – 20, 26 & 32 contacts + 2 control contacts & ground



01

Install to matching series hood/base



Screw terminal inserts





	Screw terminal inserts (mm ²)	20 + G + 2 control	26 + G + 2 control	32 + G + 2 control
	Male - Pins 20–14 AWG (0.5–2.5)	MS210V	MS210V + MS216V	2x MS216V
	Female - Sleeves 20–14 AWG (0.5–2.5)	FS110V	FS110V + FS116V	2x FS116V

01 Use small blade screwdriver to push wire entry tab in for easy contact removal.

Crimp tool



—
V Series 16 A, 600 V AC

		Number of contacts + ground connection	
		V20: (20 + G) or (26 + G) or (32 + G) + 2 Control	
Bases – standard mount			
Double lever	Housing	NPT entry (in.)	Lever locking type
			Single
	Panel base (no cover)	–	PB348
	Panel base (w/cover)	–	PB448
	Box base (no cover)	1 x ¾	–
		1 x 1	BB448MV
		2 x ¾	–
		2 x 1	BB548MV
	Box base (no cover)	1 x ¾	–
		1 x 1	BB648MV
		2 x ¾	–
		2 x 1	BB748MV
Hoods – standard mount *Plastic body – “A” 3-16 Series standard hoods include gaskets; bases and special hoods do not.			
	Side entry	1 x ¾	–
		1 x 1	SH648MV
		1 x 1½	SH748MV
	Top entry	1 x ¾	–
		1 x 1	TH848MV
		1 x 1½	TH948MV

¹ Metal “M” cover may be available. Contact your ABB sales representative.

* Indicates glass-filled thermoplastic construction, black colour (add suffix); quantity purchase may be required.

Wire pin & sleeve connectors

T Series 16 A, 600 V AC – 6, 10, 16 & 24 contacts + ground



- High-temp 200 °C rated inserts
- Silicone Viton® seals for molded-edge gaskets*
- Corrosion-resistant copper-free aluminum housings with special finish
- UL94V-O ergonomic thermoplastic handles
- Electrostatic epoxy powder-coated finish

*Viton is a trademark of DuPont Performance Elastomers.

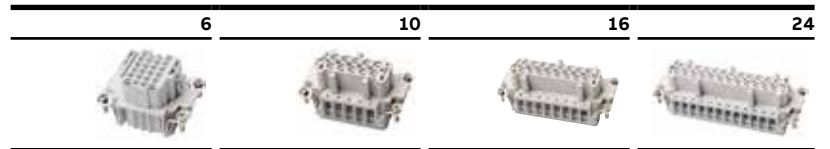
Install to matching series hood/base













Screw terminal inserts

	Screw terminal inserts* (mm²)	6 + G	10 + G	16 + G	24 + G
	Male – Pins 20–14 AWG (0.5–2.5)	MS206T	MS210T	MS216T	MS224T
	Female – Sleeve 20–14 AWG (0.5–2.5)	FS106T	FS110T	FS116T	FS124T

* Inserts may be dark brown or gray in color.

T Series 16 A, 600 V AC

Bases – standard mount		NPT entry (in.)		Number of contacts + ground connection				Lever locking type	
				6	10	16	24		
Single lever	Double lever	Housing	Single	Double	Double	Double	Double		
		Panel base	–	PB306T	PB110T	PB116T	PB124T	BASES	
		Box base (no cover)	1 x ½	BB406TMV	BB010TMV	–	–		
			1 x ¾	–	–	BB016TMV	BB024TMV		
			2 x ½	BB506TMV	BB110TMV	–	–		
			2 x ¾	–	–	BB116TMV	BB124TMV		
Hoods – standard mount									
		Side entry	1 x ½	SH606T	SH010TMV	–	–	HOODS	
			1 x ¾	–	–	SH016TMV	SH024TMV		
			1 x 1	–	–	–	SH124TMV		
		Top entry	1 x ½	TH806T	TH210T	–	–	HOODS	
			1 x ¾	–	–	TH216T	TH224T		
			1 x 1	–	–	–	TH324TMV		
Coupler hoods – inline for inline, portable or special service connections. Coupler hoods mate to standard hoods only.									
		Top entry	1 x ½	CH806T	CH610T	–	–	COUPLER	
			1 x ¾	–	–	CH616TMV	CH624T		
			1 x 1	–	–	CH716T	CH724T		

Note: Hoods and Bases are black colored to denote special T series.

Technical information

A Series

Specifications

- DIN VDE 0627/86
- DIN VDE 0627/86
- DIN VDE 0110/02.79
- DIN VDE 0110/02.79
- DIN VDE 0110-1/04.97
- DIN VDE 0110-1/04.97
- IEC 60-664-1, DIN/IEC 512
- IEC 60-664-1, DIN/IEC 512

Approvals

- MEIE, EZU, SEV
- 

Inserts

- Contacts (+ ground)
 - 3, 4, 10, 16, 32 (2 x 16)
- Working current
 - A3, A4 @ 10 A max.
 - A10–A32 @ 16 A max.
- Rated voltage
 - 600 V AC
- Test voltage
 - 4 kV eff.
- Pollution degree
 - 3
- Material
 - Glass-filled thermoplastic
- Temperature range
 - -40 °C/-40 °F to +125 °C/+257 °F
- Flammability
 - UL94 V-0

Contacts

- Material
 - Solid drilled copper alloy
- Surface
 - Hard silver plated
 - Hard gold plated available
- Contact resistance
 - ≤ 1 milliohm
- Screw terminals
 - Wire AWG
- + with wire protection
 - 20–14 AWG (0.5–2.5 mm²)
- Crimp terminals
 - 20–12 AWG (0.5–2.5 mm²)

Housings

- Materials
 - Die-cast aluminum alloy
- EPDM seal gaskets
 - Epoxy powder-coat finish
- Locking mechanisms
 - @ A3, 4, 10, 16
- Temperature range
 - -40 °C/-40 °F to +125 °C/+257 °F
- Internal protection
 - A3, 4: IP44
 - A10, 16, 32: IP65 per DIN VDE 0470, IEC 529

Thermal capacity

- per DIN/IEC 512

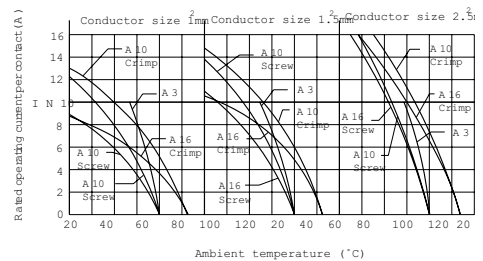

Technical information

B Series

Specifications

- DIN VDE 0627/86
- DDIN VDE 0110/02.79
- DIN VDE 0110-1/04.97
- IEC 60-664-1, DIN/IEC 512

Approvals

- MEIE, EZU, SEV
- 

Inserts

- Contacts (+ ground)
 - 6, 10, 16, 24, 32 (2 x 16), 48 (2 x 24)
- Working current
 - 16 A max.
- Rated voltage
 - 600 V AC
- Test voltage
 - 3 kV eff.
- Pollution degree
 - 3
- Material
 - Glass-filled thermoplastic
- Temperature range
 - -40 °C/-40 °F to +125 °C/+257 °F
- Flammability
 - UL94 V-0

Contacts

- Material
 - Solid drilled copper alloy
- Surface
 - Hard silver plated
 - Hard gold plated available
- Contact resistance
 - ≤ 1 milliohm
- Screw terminals
 - Wire AWG
- + with wire protection
 - 20–14 AWG (0.5–2.5 mm²)
- Crimp terminals
 - 20–12 AWG (0.5–2.5 mm²)

Housings

- Materials
 - Die-cast aluminum alloy
- EPDM seal gaskets
 - Epoxy powder-coat finish
- Temperature range
 - -40 °C/-40 °F to +125 °C/+257 °F
- Internal protection
 - IP65 locked positions
 - per DIN VDE 0470, IEC 529

Thermal capacity

- per DIN/IEC 512

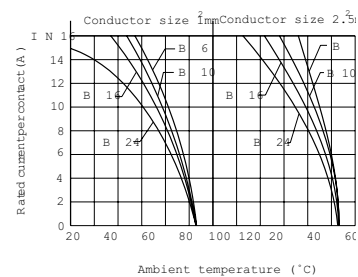

Technical information

C Series

Specifications

- DIN VDE 0627/86
- DIN VDE 0627/86
- DIN VDE 0110/02.79
- DIN VDE 0110/02.79
- DIN VDE 0110-1/04.97
- DIN VDE 0110-1/04.97
- IEC 60-664-1, DIN/IEC 512
- IEC 60-664-1, DIN/IEC 512

Approvals

- MEIE, EZU, SEV
- 

Inserts

- Contacts (+ ground)
 - 6, 12 (2 x 6)
- Working current
 - 35 A
- Rated voltage
 - 600 V AC
- Test voltage
 - 3 kV eff.
- Pollution degree
 - 3
- Material
 - Glass-filled thermoplastic
- Temperature range
 - -40 °C/-40 °F to +125 °C/+257 °F
- Flammability
 - UL94 V-0

Contacts

- Material
 - Solid drilled copper alloy
- Surface
 - Hard silver plated
 - Hard gold plated available
- Contact resistance
 - ≤ 0.5 milliohm
- Screw terminals
 - Wire AWG
- + with wire protection
 - 20–10 AWG (0.5–6.0 mm²)
- + w/o wire protection
 - n/a

Housings

- Materials
 - Die-cast aluminum alloy
- EPDM seal gaskets
 - Epoxy powder-coat finish
- Temperature range
 - -40 °C/-40 °F to +125 °C/+257 °F
- Internal protection
 - IP65 locked positions
 - per DIN VDE 0470, IEC 529

Thermal capacity

- per DIN/IEC 512

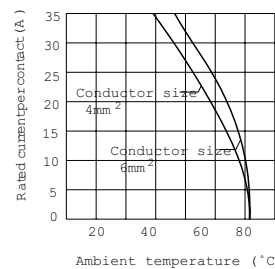

Technical information

D Series

Specifications

- DIN VDE 0627/86
- DIN 43652
- DDIN VDE 0110/02.79
- DIN VDE 0110-1/04.97
- IEC 60-664-1, DIN/IEC 512

Approvals

- MEIE, EZU, SEV
- 

Inserts

- Contacts (+ ground)
 - 7, 8, 15, 25, 40, 50 (2 x 25)
 - 64, 80 (2 x 40), 128 (2 x 64)
- Working current
 - 10 A
- Rated voltage
 - 600 V AC
- Test voltage
 - 4 kV eff.
- Pollution degree
 - 3
- Material
 - Glass-filled thermoplastic
- Temperature range
 - -40 °C/-40 °F to +125 °C/+257 °F
- Flammability
 - UL94 V-0

Contacts

- Material
 - Solid drilled copper alloy
- Surface
 - Hard silver plated
 - Hard gold plated available
- Contact resistance
 - ≤ 3 milliohm
- Crimp terminals
 - Wire AWG
 - 26–14 AWG (.142–2.5 mm²)
- > Glass fiber optic cable
 - POF {0} 1 mm

Housings

- Materials
 - Die-cast aluminum alloy
- EPDM seal gaskets
 - Epoxy powder-coat finish
- Temperature range
 - -40 °C/-40 °F to +125 °C/+257 °F
- Internal protection
 - IP65 locked positions
 - per DIN VDE 0470, IEC 529
- Thermal capacity
 - per DIN/IEC 512

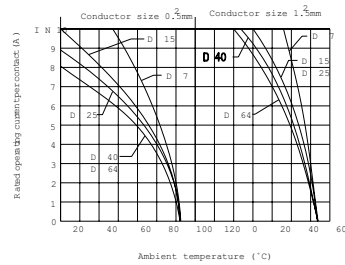

Technical information

DD Series

Specifications

- DIN VDE 0627/86
- DIN VDE 0110/02.79
- DIN VDE 0110-1/04.97
- IEC 60-664-1, DIN/IEC 512

Approvals

- MEIE, EZU, SEV
- 

Inserts

- Contacts (+ ground)
 - 24, 42, 72, 108, 144 (2 x 72)
- Working current
 - 216 (2 x 108)
 - 10 A
- Rated voltage
 - 600 V AC
- Test voltage
 - 2 kV eff.
- Pollution degree
 - 3
- Material
 - Glass-filled thermoplastic
- Temperature range
 - -40 °C/-40 °F to +125 °C/+257 °F
- Flammability
 - UL94 V-0

Contacts

- Material
 - Solid drilled copper alloy
- Surface
 - Hard silver plated
 - Hard gold plated available
- Contact resistance
 - ≤ 3 milliohm
- Crimp terminals
 - Wire AWG
 - 26–14 AWG (.14–2.5 mm²)
- > Glass fiber optic cable
 - POF {0} 1 mm

Housings

- Materials
 - Die-cast aluminum alloy
- EPDM seal gaskets
 - Epoxy powder-coat finish
- Temperature range
 - -40 °C/-40 °F to +125 °C/+257 °F
- Internal protection
 - IP65 locked positions
 - per DIN VDE 0470, IEC 529

Thermal capacity

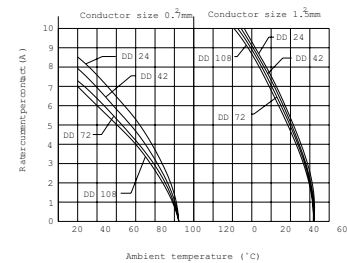

Technical information

K Series

Specifications

- DIN VDE 0627/86
- VDE 0113/1.73-10.1.3
- DDIN VDE 0110/4
- VDE 0100/5.73-42a
- IEC 60-664-1, DIN/IEC 512

Approvals

- MEIE, EZU, SEV



Inserts

- Contacts (+ ground)
 - 8 (16 A) + 4 (80 A)
 - 16 (16 A) + 8 (80 A)
- Working current
 - 16 A and 80 A dual
- Rated voltage
 - 600 V AC
- Test voltage
 - 2 kV eff.
- Pollution degree
 - 3
- Material
 - Glass-filled thermoplastic
- Temperature range
 - -40 °C/-40 °F to +125 °C/+257 °F
- Flammability
 - UL94 V-0

Contacts

- Material
 - Solid drilled copper alloy
- Surface
 - Hard silver plated
- Hard gold plated available
- Contact resistance
 - ≤ 1 milliohm
- Screw terminals
 - Wire AWG
- + with wire protection (16 A)
 - 20–14 AWG (0.5–2.5 mm²)
- (80 A contacts)
 - 18–4 AWG (1.5–16.0 mm²)

Housings

- Materials
 - Die-cast aluminum alloy
- EPDM seal gaskets
 - Epoxy powder-coat finish
- Temperature range
 - -40 °C/-40 °F to +125 °C/+257 °F
- Internal protection
 - IP65 locked positions
 - per DIN VDE 0470, IEC 529

Technical information

V Series

Specifications

- DIN VDE 0627/86
- DIN VDE 0110/02.79
- DIN VDE 0110-1/04.97
- IEC 60-664-1, DIN/IEC 512

Approvals

- MEIE, EZU, SEV
- 

Inserts

- Contacts (+ ground)
 - 3, 6, 10, 16, 20 (2 x 10)
 - 26 (10+16), 32 (2 x 16)
- Working current
 - 16 A max.
- Rated voltage
 - 600 V AC; switch contacts 400 V AC
- Test voltage
 - 3 kV eff.
- Pollution degree
 - 3
- Material
 - Glass-filled thermoplastic
- Temperature range
 - -40 °C/-40 °F to +125 °C/+257 °F
- Flammability
 - UL94 V-0

Contacts

- Material
 - Solid drilled copper alloy
- Surface
 - Hard silver plated
 - Hard gold plated available
- Contact resistance
 - ≤ 1 milliohm
- Screw terminals
 - Wire AWG
- + with wire protection
 - 20–14 AWG (0.5–2.5 mm²)
- Crimp terminals
 - 20–12 AWG (0.5–2.5 mm²)

Housings

- Materials
 - Die-cast aluminum alloy
- EPDM seal gaskets
 - Epoxy powder-coat finish
- Temperature range
 - -40 °C/-40 °F to +125 °C/+257 °F
- Internal protection
 - IP65 locked positions
 - per DIN VDE 0470, IEC 529

Thermal capacity

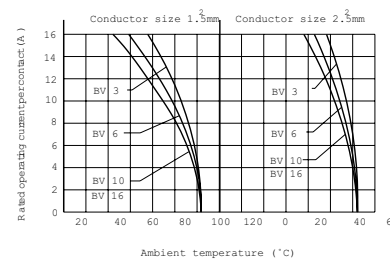

Technical information

T Series

Specifications

- DIN VDE 0627/86
- DDIN VDE 0110/02.79
- DIN VDE 0110-1/04.97
- IEC 60-664-1, DIN/IEC 512

Approvals

- MEIE, EZU, SEV
- 

Inserts

- Contacts (+ ground)
 - 6, 10, 16, 24
- Working current
 - 16 A max.
- Rated voltage
 - 600 V AC; switch contacts 400 V AC
- Test voltage
 - 3 kV eff.
- Pollution degree
 - 3
- Material
 - Hi-temp thermoplastic
- Temperature range
 - -40 °C/-40 °F to +200 °C/+392 °F
- Flammability
 - UL94 V-0

Contacts

- Material
 - Solid drilled copper alloy
- Surface
 - Hard silver plated
 - Hard gold plated available
- Contact resistance
 - ≤ 1 milliohm
- Screw terminals
 - Wire AWG
- + with wire protection
 - 20–14 AWG (0.5–2.5 mm²)

Housings

- Materials
 - Copper-free die-cast aluminum alloy
- Viton® seal gaskets
 - Green epoxy powder coating
- Temperature range
 - -40 °C/-40 °F to +200 °C/+392 °F
- Internal protection
 - IP65 locked positions
 - per DIN VDE 0470, IEC 529

Thermal capacity

- per DIN/IEC 512

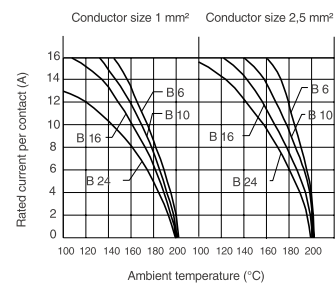

Technical information

Mounting dimensions for lever box bases

Mounting dimensions for double lever box bases

Housing series					Dimensions are in inches/(millimeters)						
A, B, T, K	C, V	D	DD	Cat. no.	A	B	C	D	E	F	G
A32	D50	-	-	BB_32A__	3.70/(94)	4.17/(106)	5.04/(128)	1.81/(46)	2.20/(56)	2.76/(70)	3.40/(86.5)
B10, T10	V3	-	DD42	BB_10E	3.23/(82)	3.66/(93)	4.33/(110)	1.57/(40)	2.05/(52)	2.28/(58)	2.05/(52)
				BB_10EH__	3.23/(82)	3.66/(93)	4.33/(110)	1.77/(45)	2.24/(57)	2.28/(58)	2.92/(74)
B16, T16	C6, V6	D40	DD72	BB_16E	4.13/(105)	4.61/(117)	5.16/(131)	1.77/(45)	2.24/(57)	2.28/(58)	2.68/(68)
				BB_16EH__	4.13/(105)	4.61/(117)	5.16/(131)	1.77/(45)	2.24/(57)	2.28/(58)	3.31/(84)
B24, T24, K12	V10, V16	D64	DD108	BB_24E	5.20/(132)	5.67/(144)	6.18/(157)	1.77/(45)	2.24/(57)	2.28/(58)	2.68/(68)
				BB_24EH__	5.20/(132)	5.67/(144)	6.18/(157)	1.77/(45)	2.24/(57)	2.28/(58)	3.31/(84)
B32	C12	D80	DD144	BB_32E	4.41/(112)	4.88/(112)	5.28/(134)	2.64/(67)	3.20/(81.5)	3.62/(92)	2.83/(72)

Dimensions

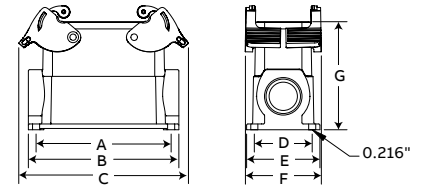

Mounting dimensions for single lever box bases

Housing series					Dimensions are in inches/(millimeters)						
A, B, T, K	C, V	D	DD	Cat. no.	A	B	C	D	E	F	G
A3, A4	-	D7, D8	-	BB403A(P)*	1.10/(28)	1.59/(40.5)	1.00/(25.5)	1.42/(36)	1.18/(30)	1.50/(38)	-
A10	-	D15	-	BB_10A	1.89/(48)	-	3.66/(93)	1.57/(40)	1.97/(50)	2.32/(59)	2.05/(52)
A16	-	D25	-	BB_16A	2.52/(64)	-	4.29/(109)	1.57/(40)	1.97/(50)	2.32/(59)	2.24/(57)
B6, T6	-	-	DD24	BB_06	2.76/(70)	3.31/(84)	-	1.57/(40)	2.05/(52)	2.72/(69)	2.05/(52)
				BB_06H075	2.76/(70)	3.31/(84)	-	1.77/(45)	2.24/(57)	2.72/(69)	2.92/(74)
				BB_06H100	2.76/(70)	3.31/(84)	-	1.77/(45)	2.24/(57)	2.72/(69)	2.92/(74)
B10, T10	V3	-	DD42	BB_10	3.23/(82)	3.66/(93)	-	1.57/(40)	2.05/(52)	2.80/(71)	2.05/(52)
				BB_10H075	3.23/(82)	3.66/(93)	-	1.77/(45)	2.24/(57)	2.80/(71)	2.92/(74)
				BB_10H100	3.23/(82)	3.66/(93)	-	1.77/(45)	2.24/(57)	2.80/(71)	2.92/(74)
B16, T16	C6, V6	D40	DD72	BB_16	4.13/(105)	4.61/(117)	-	1.77/(45)	2.24/(57)	2.91/(74)	2.68/(68)
				BB_16H___	4.13/(105)	4.61/(117)	-	1.77/(45)	2.24/(57)	2.91/(74)	3.31/(84)
B24, T24, K12	V10, V16	D64	DD108	BB_24	5.20/(132)	5.67/(144)	-	1.77/(45)	2.24/(57)	2.91/(74)	2.68/(68)
				BB_24H___	5.20/(132)	5.67/(144)	-	1.77/(45)	2.24/(57)	2.91/(74)	3.31/(84)
B48, K24, V32	V20, V26	D128	DD216	BB_48	4.37/(111)	5.71/(145)	-	4.17/(106)	4.72/(120)	6.18/(157)	3.94/(100)

Dimensions
Right angle housing
A3/A4
D7/D8
only

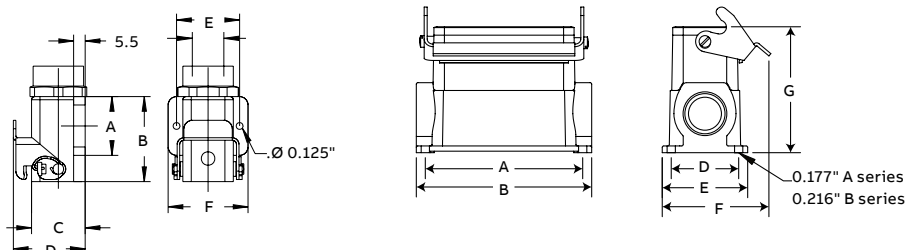

* Suffix: A – Aluminum, P – Plastic.

Technical information

Mounting dimensions for lever panel bases

Mounting dimensions for double lever panel bases

Housing series				Dimensions are in inches/(millimeters)							
A, B, T, K	C, V	D	DD	Cat. no.	A	B	C	D	E	F	G
A32	D50	-	-	PB132A	3.62/(92)	4.02/(102)	5.04/(128)	1.65/(28)	2.24/(57)	2.76/(70)	1.10/(28)
B10, T10	V3	-	DD42	PB110E	3.27/(83)	3.66/(93)	4.33/(110)	1.26/(32)	1.69/(43)	2.28/(58)	1.06/(27)
B16, T16	C6, V6	D40	DD72	PB116E	4.05/(103)	4.49/(114)	5.16/(131)	1.26/(32)	1.69/(43)	2.28/(58)	1.06/(27)
B24, T24, K12	V10, V16	D64	DD108	PB124E	5.12/(130)	5.51/(140)	6.19/(157)	1.26/(32)	1.69/(43)	2.28/(58)	1.06/(27)
B32	C12	D80	DD144	PB132E	4.33/(110)	4.88/(124)	5.28/(134)	2.56/(65)	3.11/(79)	3.62/(92)	1.18/(30)

Dimensions

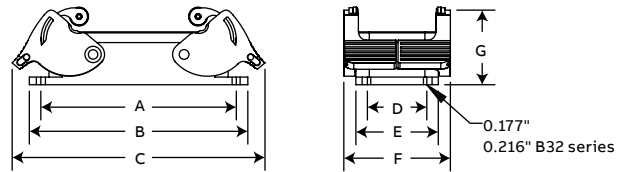

Mounting dimensions for single lever panel bases

Housing series				Dimensions are in inches/(millimeters)							
A, B, T, K	C, V	D	DD	Cat. no.	A	B	C	D	E	F	G
A3, A4	-	D7, D8	-	PB303A (P)*	-	1.10/(28)	1.34/(34)	1.18/(30)	1.50/(38)	1.67/(42.5)	0.95/(24)
				PB403A (P)*		1.10/(28)	1.38/(35)	1.18/(30)	1.58/(40)	1.85/(47)	0.95/(24)
				PB503A (P)	1.10/(28)	1.59/(40.5)	1.00/(25.5)	1.42/(36)	1.18/(30)	1.50/(38)	-
A10	-	D15	-	PB310A	2.76/(70)	3.19/(81)	-	.68/(17.5)	1.20/(30.5)	1.93/(49)	1.02/(26)
				PB410A	2.76/(70)	3.19/(81)	-	.68/(17.5)	1.20/(30.5)	2.95/(75)	1.02/(26)
A16	-	D25	-	PB316A	3.39/(86)	3.78/(96)	-	.68/(17.5)	1.20/(30.5)	1.93/(49)	1.02/(26)
				PB416A	3.39/(86)	3.78/(96)	-	.68/(17.5)	1.20/(30.5)	2.95/(75)	1.02/(26)
B6, T6	-	-	DD24	PB306	2.76/(70)	3.15/(80)	-	1.26/(32)	1.69/(43)	2.56/(65)	1.06/(27)
				PB406	2.76/(70)	3.15/(80)	-	1.26/(32)	1.69/(43)	3.54/(90)	1.06/(27)
B10, T10	V3	-	DD42	PB310	3.27/(83)	3.66/(93)	-	1.26/(32)	1.69/(43)	2.64/(67)	1.06/(27)
				PB410	3.27/(83)	3.66/(93)	-	1.26/(32)	1.69/(43)	3.62/(92)	1.06/(27)
B16, T16	C6, V6	D40	DD72	PB316	4.06/(103)	4.49/(114)	-	1.26/(32)	1.69/(43)	2.64/(67)	1.06/(27)
				PB416	4.06/(103)	4.49/(114)	-	1.26/(32)	1.69/(43)	3.62/(92)	1.06/(27)
B24, T24, K12	V10, V16	D64	DD108	PB324	5.12/(130)	5.51/(140)	-	1.26/(32)	1.69/(43)	2.64/(67)	1.06/(27)
				PB424	5.12/(130)	5.51/(140)	-	1.26/(32)	1.69/(43)	3.62/(92)	1.06/(27)
B48, K24, V32	V20, V26	D128	DD216	PB348	5.83/(148)	6.50/(165)	-	2.76/(70)	3.54/(90)	6.18/(157)	1.61/(41)
				PB448	5.83/(148)	6.50/(165)	-	2.76/(70)	3.54/(90)	6.81/(173)	1.61/(41)

Dimensions
A3/A4
D7/D8
only

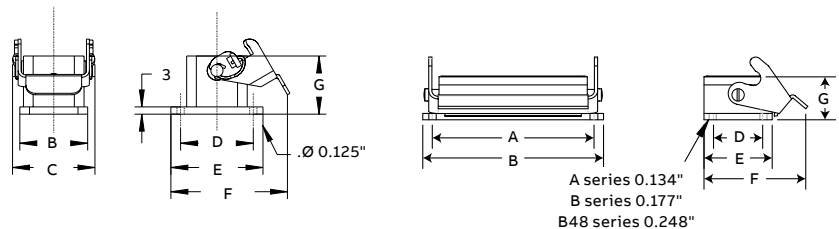

* Suffix: A – Aluminum, P – Plastic.

Technical information

Mounting dimensions for screw and crimp terminal inserts

Housing series					Dimensions are in inches/(millimeters)				
A, B, T, K	C, V	D	DD	Mating	A	B	C	D	E
A3, A4	-	-	-	Both	-	0.83/(21)	-	0.83/(21)	0.98/(25)
				Female	-	0.83/(21)	-	0.83/(21)	1.25/(31.8)
				Male	-	0.83/(21)	-	0.83/(21)	1.19/(30.2)
A10	-	D15	-	Female	1.95/(49.5)	2.22/(56.5)	0.63/(16)	1.34/(34)	1.14/(29)
				Male	1.95/(49.5)	2.22/(56.5)	0.63/(16)	1.34/(34)	1.26/(32)
A16	-	D25	-	Female	2.60/(66)	2.87/(73)	0.63/(16)	1.34/(34)	1.14/(29)
				Male	2.60/(66)	2.87/(73)	0.63/(16)	1.34/(34)	1.26/(32)
A32	-	D50	-	Female	2.60/(66)	2.87/(73)	0.63/(16) x 2	1.34/(34)	1.14/(29)
				Male	2.60/(66)	2.87/(73)	0.63/(16) x 2	1.34/(34)	1.26/(32)
B6, T6	-	-	DD24	Female	1.73/(44)	2.01/(51)	1.063/(27)	1.34/(34)	1.46/(37)
				Male	1.73/(44)	2.01/(51)	1.063/(27)	1.34/(34)	1.38/(35)
B10, T10	V3	-	DD42	Female	2.24/(57)	2.52/(64)	1.063/(27)	1.34/(34)	1.46/(37)
				Male	2.24/(57)	2.52/(64)	1.063/(27)	1.34/(34)	1.38/(35)
B16, T16	C6, V6	D40	DD72	Female	3.05/(77.5)	3.33/(84.5)	1.063/(27)	1.34/(34)	1.48/(37.5)
				Male	3.05/(77.5)	3.33/(84.5)	1.063/(27)	1.34/(34)	1.40/(35.5)
B24, T24, K12	V10, V16	D64	DD108	Female	4.09/(104)	4.37/(111)	1.063/(27)	1.34/(34)	1.48/(37.5)
				Male	4.09/(104)	4.37/(111)	1.063/(27)	1.34/(34)	1.40/(35.5)
B32	C12	D80	DD144	Female	3.05/(77.5)	3.33/(84.5)	1.063/(27) x 2	1.34/(34)	1.48/(37.5)
				Male	3.05/(77.5)	3.33/(84.5)	1.063/(27) x 2	1.34/(34)	1.40/(35.5)
B48, K24	V20, V26, V32	D128	DD216	Female	4.09/(104)	4.37/(111)	1.063/(27) x 2	1.34/(34)	1.48/(37.5)
				Male	4.09/(104)	4.37/(111)	1.063/(27) x 2	1.34/(34)	1.40/(35.5)

Dimensions

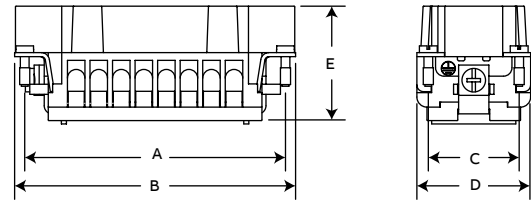

Technical information

Insert screw torque specifications

Insert mounting screws accept a Pozi-drive screwdriver head. Common cross-point or bladed screwdrivers will also work. Specs refer to Pozi-drive or bladed common torque only.

Series	Screw location	Unit of measure screwdriver	Pozi-drive point screwdriver	Std. straight-blade
A3	Wire termination screw	Newton meters	0.4	0.9
A4		Inch ounces	57	127
	Insert grounding screw	Newton meters	0.6	0.8
		Inch ounces	85	113
D7	Grounding screw	Newton meters	0.4	0.4
D8		Inch ounces	57	57
A10	Wire termination screw	Newton meters	0.4	0.9
A16		Inch ounces	57	127
A32	Insert fastening screw	Newton meters	0.7	1.1
		Inch ounces	99	156
	Insert grounding screw	Newton meters	0.7	1.3
		Inch ounces	99	184
D15	Insert fastening screw	Newton meters	0.7	1.1
D25		Inch ounces	99	156
D50	Insert grounding screw	Newton meters	0.7	1.3
		Inch ounces	99	184
B	Wire termination screw	Newton meters	0.4	0.6
T		Inch ounces	57	85
V	Insert fastening screw	Newton meters	0.7	1.1
		Inch ounces	99	156
	Insert grounding screw	Newton meters	1.2	1.9
		Inch ounces	170	269
C	Wire termination screw	Newton meters	0.7	1.3
		Inch ounces	99	184
	Insert fastening screw	Newton meters	0.7	1.1
		Inch ounces	99	156
	Insert grounding screw	Newton meters	2.3	2.3
		Inch ounces	326	326
K	Wire termination screw	Newton meters	0.5/1.4*	-
		Inch ounces	71/198*	
	Insert fastening screw	Newton meters	0.7	
		Inch ounces	99	
	Insert grounding screw	Newton meters	2.3	
		Inch ounces	326	

* 16 A/80 A contacts.

Note: Inch ounces/16.0 = pound/inches.

Technical information

Mounting dimensions for wiring adapters

Insert series	Cat. no.	Dimensions are in inches/(millimeters)							
		A	B	C	D	E	F	G	H
B6	FS106WAL	1.73/(44)	2.01/(51)	1.03/(26.3)	1.06/(27)	1.34/(34)	1.77/(45)	2.28/(58)	3.54/(90)
	FS106WAR								
	MS206WAL								
	MS206WAR								
B10	FS110WAL	2.13/(54)	2.52/(64)	1.55/(39.5)	1.06/(27)	1.34/(34)	1.77/(45)	2.28/(58)	3.54/(90)
	FS110WAR								
	MS210WAL								
	MS210WAR								
B16	FS116WAL	3.05/(77.5)	3.32/(84.5)	2.33/(59.3)	1.06/(27)	1.34/(34)	1.77/(45)	2.28/(58)	3.54/(90)
	FS116WAR								
	MS216WAL								
	MS216WAR								
B24	FS124WAL	4.09/(104)	4.37/(111)	3.36/(85.7)	1.06/(27)	1.34/(34)	1.77/(45)	2.28/(58)	3.54/(90)
	FS124WAR								
	MS224WAL								
	MS224WAR								
D40	FS340WAL	3.05/(77.5)	3.27/(83)	2.21/(56)	1.06/(27)	1.34/(34)	3.19/(81)	4.53/(115)	5.12/(130)
	MS440WAL								
D64	FS364WAL	4.09/(104)	4.33/(110)	3.39/(86.3)	1.06/(27)	1.34/(34)	3.19/(81)	4.53/(115)	5.12/(130)
	MS464WAL								

Dimensions

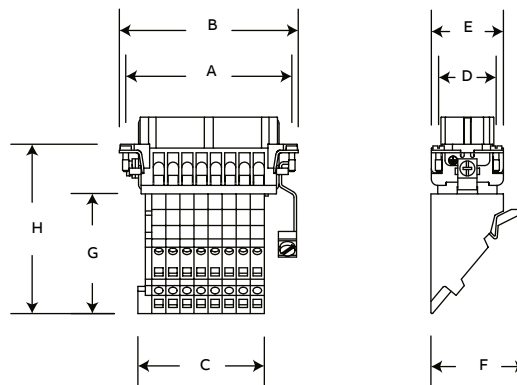

-WAL – Ground left, -WAR – Ground right.

Technical information

Panel cut out dimensions for panel bases

Housing series				Dimensions are in inches/(millimeters)				
A, B, T, K	C, V	D	DD	A	B	C	D	E
A3, A4	-	D7, D8	-	0.83/(21)	1.18/(30)	0.83/(21)	-	0.125/(3.2)
A10	-	D15	-	1.71/(43.5)	2.76/(70)	0.95/(24)	0.68/(17.5)	0.134/(3.4)
A16	-	D25	-	2.36/(60)	3.39/(86)	0.95/(24)	0.68/(17.5)	0.134/(3.4)
A32	-	D50	-	2.36/(60)	3.62/(92)	1.89/(48)	1.65/(28)	0.177/(4.5)
B6, T6	-	-	DD24	1.42/(36)	2.76/(70)	1.38/(35)	1.26/(32)	0.177/(4.5)
B10, T10	V3	-	DD42	1.93/(49)	3.27/(83)	1.38/(35)	1.26/(32)	0.177/(4.5)
B16, T16	C6, V6	D40	DD72	2.84/(72)	4.06/(103)	1.38/(35)	1.26/(32)	0.177/(4.5)
B24, T24, K12	V10, V16	D64	DD108	3.86/(98)	5.12/(130)	1.38/(35)	1.26/(32)	0.177/(4.5)
B32	C12	D80	DD144	2.84/(72)	4.33/(110)	2.80/(71)	2.56/(65)	0.216/(5.5)
B48, K24	V20, V26, V32	D128	DD216	3.86/(98)	5.83/(148)	2.80/(71)	2.76/(70)	0.248/(6.3)

Dimensions

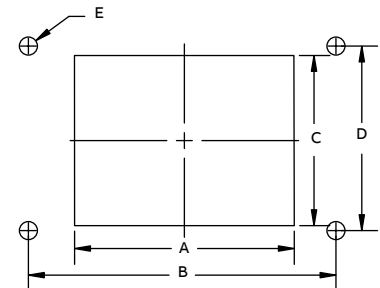
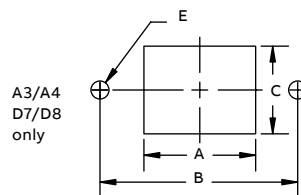

* Dimensions reflect dual inserts mounting.

Technical information

Mounting dimensions for double post hoods

Cat. no.	Housing series				Dimensions are in inches/(millimeters)		
	A, B, T, K	C, V	D	DD	A	B	C
SH_32A	A32	-	D50	-	3.23/(82)	2.21/(56)	2.99/(76)
TH_32A	-	-	-	-	3.23/(82)	2.21/(56)	2.99/(76)
SH_10	-	-	-	-	2.87/(73)	1.69/(43)	2.05/(52)
M3SH_10H_---	B10, T10	V3	-	DD42	2.87/(73)	1.69/(43)	2.05/(52)
TH_10	-	-	-	-	2.87/(73)	1.69/(43)	2.05/(52)
TH_10H_---	-	-	-	-	2.87/(73)	1.69/(43)	2.05/(52)
SH_16	-	-	-	-	3.70/(94)	1.69/(43)	2.56/(65)
SH_16H	-	-	-	-	3.70/(94)	1.69/(43)	2.99/(76)
M5SH_16L	B16, T16	C6, V6	D40	DD72	3.70/(94)	1.69/(43)	2.36/(60)
TH_16	-	-	-	-	3.70/(94)	1.69/(43)	2.56/(65)
TH_16H	-	-	-	-	3.70/(94)	1.69/(43)	2.99/(76)
TH_16L	-	-	-	-	3.70/(94)	1.69/(43)	2.36/(60)
SH_24	-	-	-	-	4.72/(120)	1.69/(43)	2.36/(60)
SH_24H	-	-	-	-	4.72/(120)	1.69/(43)	2.99/(76)
M7TH_24	B24, T24, K12	V10, V16	D64	DD108	4.72/(120)	1.69/(43)	2.21/(56)
TH_24H	-	-	-	-	4.72/(120)	1.69/(43)	2.99/(76)
TH424RC	-	-	-	-	4.72/(120)	1.69/(43)	2.99/(76)
SH_32	B32	C12	D80	DD144	3.70/(94)	3.11/(79)	3.15/(80)
TH_32	-	-	-	-	3.70/(94)	3.11/(79)	3.15/(80)

Dimensions

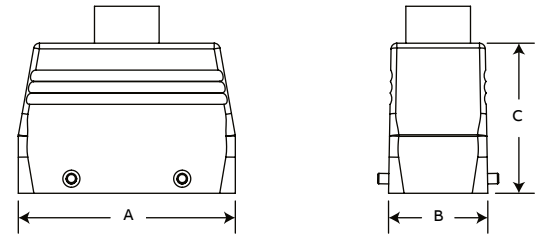

Suffix: A – Aluminum, P – Plastic, H – High profile, L – Low profile, RC – Ribbon cable (top).

Technical information

Mounting dimensions for single post hoods

Cat. no.	Housing series				Dimensions are in inches/(millimeters)		
	A, B, T, K	C, V	D	DD	A	B	c
SH603A(P)V	A3, A4	-	D7, D8	-	1.04/(26.5)	1.04/(26.5)	1.89/(48)
TH803A(P)V	-	-	-	-	1.04/(26.5)	1.04/(36.5)	1.89/(48)
SH_10A	-	-	-	-	2.48/(63)	1.42/(36)	2.60/(66)
SH_10AL	A10	-	D15	-	2.48/(63)	1.16/(29.5)	2.09/(53)
TH_10A	-	-	-	-	2.48/(63)	1.42/(36)	2.60/(66)
TH_10AL	-	-	-	-	2.48/(63)	1.16/(29.5)	2.09/(53)
SH_16A	-	-	-	-	3.13/(79.5)	1.42/(36)	2.84/(72)
SH_16AL	A16	-	D25	-	3.13/(79.5)	1.16/(29.5)	2.28/(58)
TH_16A	-	-	-	-	3.13/(79.5)	1.42/(36)	2.84/(72)
TH_16AL	-	-	-	-	3.13/(79.5)	1.16/(29.5)	2.28/(58)
SH_606	-	-	-	-	2.36/(60)	1.69/(43)	1.69/(43)
M2SH_606Hxxx	B6, T6	-	-	DD24	2.36/(60)	1.69/(43)	2.84/(72)
TH_806	-	-	-	-	2.36/(60)	1.69/(43)	1.69/(43)
TH_806Hxxx	-	-	-	-	2.36/(60)	1.69/(43)	2.84/(72)
SH_610	-	-	-	-	2.87/(73)	1.69/(43)	2.05/(52)
M3SH_610Hxxx	B10, T10	V3	-	DD42	2.87/(73)	1.69/(43)	2.84/(72)
TH_810	-	-	-	-	2.87/(73)	1.69/(43)	2.05/(52)
TH_810Hxxx	-	-	-	-	2.87/(73)	1.69/(43)	2.84/(72)
SH_616	-	-	-	-	3.70/(94)	1.69/(43)	2.56/(65)
SH_616H	-	-	-	-	3.70/(94)	1.69/(43)	2.99/(76)
SH_616L	-	-	-	-	3.70/(94)	1.69/(43)	2.36/(60)
M5TH_816	B16, T16	C6, V6	D40	DD72	3.70/(94)	1.69/(43)	2.56/(65)
TH_816H	-	-	-	-	3.70/(94)	1.69/(43)	2.99/(76)
TH_816L	-	-	-	-	3.70/(94)	1.69/(43)	2.36/(60)
TH816RC	-	-	-	-	3.70/(94)	1.69/(43)	2.99/(76)
SH_624	-	-	-	-	4.72/(120)	1.69/(43)	2.99/(76)
M7SH_624L	B24, T24	V10, V16	D64	DD108	4.72/(120)	1.69/(43)	2.36/(60)
TH_824	-	-	-	-	4.72/(120)	1.69/(43)	2.99/(76)
TH824L	K12	-	-	-	4.72/(120)	1.69/(43)	2.36/(60)
TH624RC	-	-	-	-	4.72/(120)	1.69/(43)	2.99/(76)
SH_48	B48, K24	V20, V26	D128	DD216	5.16/(131.5)	3.50/(89)	3.78/(96)
TH_48	-	V32	-	-	5.16/(131.5)	3.50/(89)	3.78/(96)

Dimensions

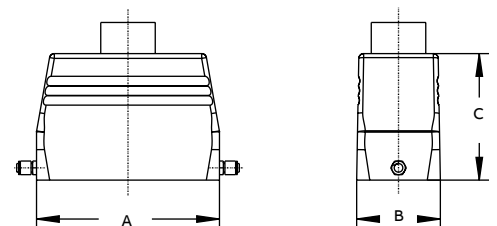

Suffix: P – Plastic, H – High profile, L – Low profile, RC – Ribbon cable (top entry only).

Technical information

Mounting dimensions for lever coupler hoods

Mounting dimensions for double lever coupler hoods

Cat. no.	Housing series				Dimensions (in)/(mm)				
	A, B, T, K	C, V	D	DD	A	B	C	D	E
CH610E	B10, T10	V3	-	DD42	2.87/(73)	4.33/(110)	1.69/(43)	2.28/(58)	2.02/(51.5)
CH610EHxxx					2.87/(73)	4.33/(110)	1.69/(43)	2.28/(58)	2.87/(73)
CH_16E	B16, T16	C6, V6	D40	DD72	3.70/(94)	5.16/(131)	1.69/(43)	2.28/(58)	2.72/(69)
CH_16EH					3.70/(94)	5.16/(131)	1.69/(43)	2.28/(58)	3.15/(80)
CH616ERC	B24, T24, K12	C6, V6	D40	DD72	3.70/(94)	5.16/(131)	1.69/(43)	2.28/(58)	3.15/(80)
CH_24E					4.72/(120)	6.18/(157)	1.69/(43)	2.28/(58)	3.15/(80)
CH624ERC	B32	C12	D80	DD144	4.72/(120)	6.18/(157)	1.69/(43)	2.28/(58)	3.15/(80)
CH_32E					3.70/(94)	5.28/(134)	3.11/(79)	3.62/(92)	3.23/(82)

Dimensions

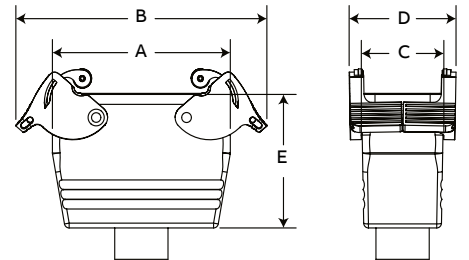

H – High profile, RC – Ribbon cable (top entry).

Mounting dimensions for single lever coupler hoods

Cat. no.	Housing series				Dimensions (in)/(mm)				
	A, B, T, K	C, V	D	DD	A	B	C	D	E
CH803A(P)*	A3, A4	-	D7, D8	-	1.34/(34)	-	1.04/(26.5)	1.43/(36.5)	2.02/(51.5)
CH810A	A10		D15		2.48/(63)		1.16/(29.5)	1.92 (49)	1.89/(48)
CH816A	A16	C6, V6	D25		3.13/(79.5)		1.16/(29.5)	1.92 (49)	2.09/(53)
CH806	B6, T6	-	-	DD24	2.36/(60)	-	1.69/(43)	2.56/(65)	2.02/(51.5)
CH806Hxxx					2.36/(60)		1.69/(43)	2.56/(65)	2.87/(73)
CH810	B10, T10	V3	-	DD24	2.87/(73)	-	1.69/(43)	2.64/(67)	2.02/(51.5)
CH810Hxxx					2.87/(73)		1.69/(43)	2.64/(67)	2.87/(73)
CH_16					3.70/(94)		1.69/(43)	2.64/(67)	2.72/(69)
CH_16H	B16, T16	C6, V6	D40	DD72	3.70/(94)	-	1.69/(43)	2.64/(67)	3.15/(80)
CH616RC					3.70/(94)		1.69/(43)	2.64/(67)	3.15/(80)
CH_24	B24, T24	V10, V16	D64	DD108	4.72/(120)	-	1.69/(43)	2.64/(67)	3.15/(80)
CH824RC					4.72/(120)		1.69/(43)	2.64/(67)	3.15/(80)

Dimensions
A3/A4
D7/D8
Only

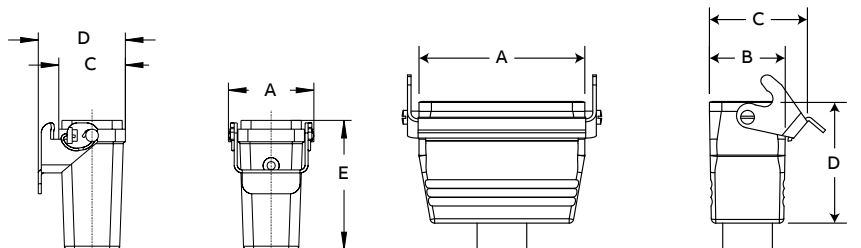

*Suffix: A – Aluminum, P – Plastic, H – High profile, L – Low profile, RC – Ribbon cable (top entry only).

Technical information

Mounting dimensions for double post box bases (reverse locking)

Mounting dimensions for double post box bases (reverse locking)

Cat. no.	Housing series				Dimensions (in)/(mm)					
	A, B, T, K	C, V	D	DD	A	B	C	D	E	F
BB_32A	A32	-	D50	-	3.70/(94)	4.17/(106)	1.81/(46)	2.32/(59)	3.11/(79)	3.20/(81.5)
BB_32A100					3.70/(94)	4.17/(106)	1.81/(46)	2.32/(59)	3.11/(79)	3.20/(81.5)
BB_10	B10, T10	V3	-	DD42	3.23/(82)	3.66/(93)	1.56/(40)	2.05/(52)	2.87/(73)	2.05/(52)
BB_10H*					3.23/(82)	3.66/(93)	1.77/(45)	2.24/(57)	2.97/(75.5)	2.91/(74)
BB_16	B16, T16	C6, V6	D40	DD72	4.13/(105)	4.61/(117)	1.77/(45)	2.24/(57)	2.97/(75.5)	2.68/(68)
BB_24					5.20/(132)	5.67/(144)	1.77/(45)	2.24/(57)	2.97/(75.5)	2.68/(68)
BB_24	B24, T24,	C6, V6	D40	DD72	5.20/(132)	5.67/(144)	1.77/(45)	2.24/(57)	2.97/(75.5)	2.68/(68)
BB_24H*	K12				5.20/(132)	5.67/(144)	1.77/(45)	2.24/(57)	2.97/(75.5)	3.31/(84)

Dimensions

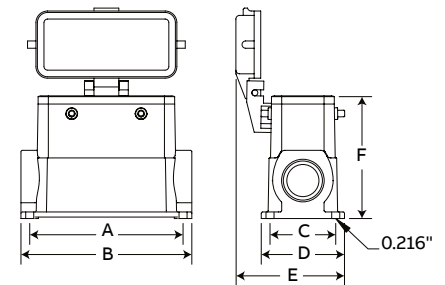

* H – High profile.

Mounting dimensions for double post box panel bases (reverse locking)

Cat. no.	Housing series				Dimensions (in)/(mm)					
	A, B, T, K	C, V	D	DD	A	B	C	D	E	F
PB232A	A32	-	D50	-	3.62/(92)	4.02/(102)	1.65/(42)	2.24/(57)	3.15/(80)	1.10/(28)
PB210	B10, T10	V3	-	DD42	3.27/(83)	3.66/(93)	1.26/(32)	1.69/(43)	2.68/(68.5)	1.06/(27)
PB216	B16, T16	C6, V6	D40	DD72	4.06/(103)	4.49/(114)	1.26/(32)	1.69/(43)	2.68/(68.5)	1.06/(27)
PB224	B24, T24,	C6, V6	D40	DD72	5.12/(130)	5.51/(140)	1.26/(32)	1.69/(43)	2.68/(68.5)	1.06/(27)
	K12									

Dimensions

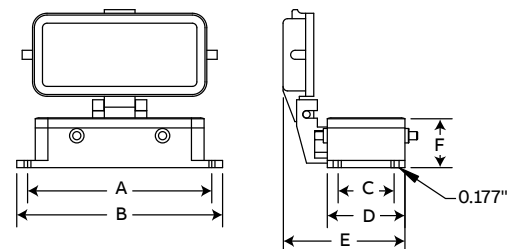

Technical information

Mounting dimensions for double lever hoods (reverse locking) & dust covers for housings

Mounting dimensions for double lever hoods (reverse locking)

Housing series					Dimensions are in inches/(millimeters)				
A, B, T, K	C, V	D	DD	Cat. no.	A	B	C	D	E
A32	–	D50	–	LH_32A	3.23/(82)	5.04/(128)	2.21/(56)	2.76/(70)	2.99/(76)
B10, T10	V3	–	DD42	LH_10E	2.87/(73)	4.33/(110)	1.69/(43)	2.28/(58)	1.89/(48)
				LH_10EH*	2.87/(73)	4.33/(110)	1.69/(43)	2.28/(58)	2.84/(72)
B16, T16	C6, V6	D40	DD72	LH_16E	3.70/(94)	5.16/(131)	1.69/(43)	2.28/(58)	2.56/(65)
				LH_16EH*	3.70/(94)	5.16/(131)	1.69/(43)	2.28/(58)	2.99/(76)
B24, T24, K12	V10, V16	D64	DD108	LH_24E	4.72/(120)	6.18/(157)	1.69/(43)	2.28/(58)	2.99/(76)

Dimensions

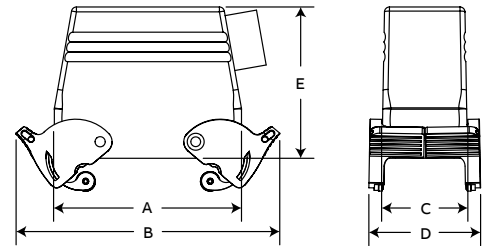

*H – High Profile



Dust covers for housings

Housing series				For single-lever housings	For double-lever housings	For single-post housings	For double-post housings
A, B, T, K	C, V	D	DD				
A3, A4	–	D7, D8	–	DCL103A-1	–	–	–
A10	–	D15	–	DCL110A-1	–	DCS110A-1	–
A16	–	D25	–	DCL116A-1	–	DCS116A-1	–
A32	–	D50	–	–	DCL232A-1/ DCL432A-1*	–	DCS232A-1
B6, T6**	–	–	DD24	DCL106B-1	–	–	–
B10, T10**	V3	–	DD42	DCL110B-1	DCL210B-1/ DCL410B-1*	–	–
B16, T16**	C6, V6	D40	DD72	DCL116B-1	DCL216B-1/ DCL416B-1*	–	–
B24, T24**, K12	V10, V16	D64	DD108	DCL124B-1	DCL224B-1/ DCL424B-1*	–	–

* Comes with gasket for hoods with levers and without gaskets.

** Dust covers tested only to 125 °C (if applied to 200 °C Series T).

Technical information

Gaskets

Gaskets

Cat. no.		Housing series			
Panel base, flat	Molded edge contour*	A, B, T, K	C, V	D	DD
A04XFGP	A04XMEC	A3, A4	-	D7, D8	-
A10XFGP	A10XMEC	A10	-	D15	-
A16XFGP	A16XMEC	A16	-	D25	-
A32XFGP	A32XMEC	A32	-	D50	-
B6XFGP	B6XMEC	B6, T6**	-	-	DD24
B10XFGP	B10XMEC	B10, T10**	V3	-	DD42
B16XFGP	B16XMEC	B16, T16**	V6, C6	D40	DD72
B24XFGP	B24XMEC	B24, T24**, K12	V10, V16	D64	DD108
B32XFGP	B32XMEC	B32	C12	D80	DD144
B48XFGP	B48XMEC	B48, K24	V20, V26, V32	D128	DD216

* Install with silicone sealant/adhesive for industrial use.

** For T Series 200 °C applications, specify catalogue number except use "T" prefix instead of "B" for gaskets. EX: use "T16XFGP" for panel base gaskets.

Technical information

Coding pins, guide pins and sleeves can be used in all series housings, with all inserts

- 01 Coding pin – PC600
- 02 Guide pin – MG601
- 03 Guide sleeve – FG602



Coding pins:

Used for rejection in multiple “same size or series” insert/hood installations. Patterns show examples of rejection coding pins installed.

Coding possibilities for single insert series

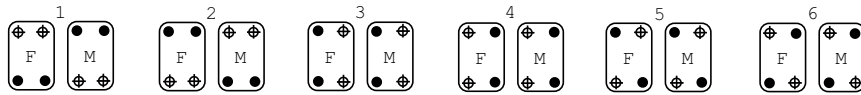

Coding possibilities for double insert series

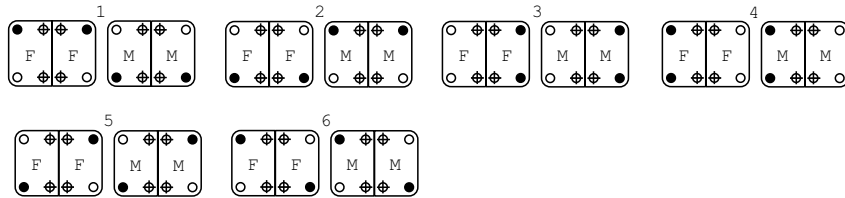

Guide pins and sleeves:

Perform same function as coding pins and/or aid high-density insert mating as well.

Coding possibilities for single insert series

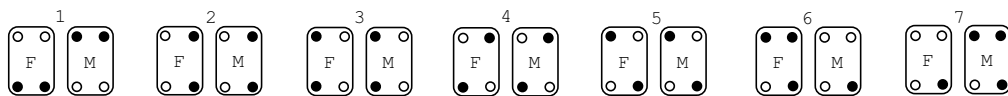

Coding possibilities for double insert series

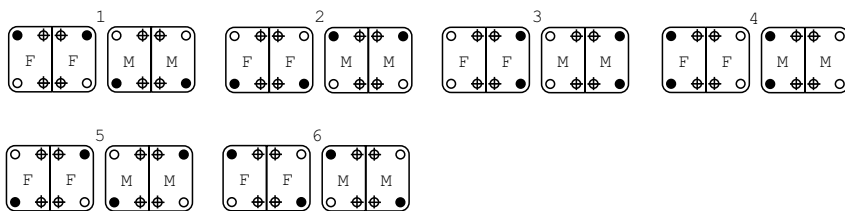

- Male guide pins or coding pins
- Female guide sleeves
- ⊕ Mounting screw

Technical information

Metric PG-to-NPT, ISO-to-NPT thread adapters & cord grip connectors

Metric PG-to-NPT thread adapters

	Cat. no.	NPT thread (mating) (in.)	Thread (at housing)
	PG11-38	$\frac{3}{8}$	PG11
	PG16-50	$\frac{1}{2}$	PG16
	PG21-75	$\frac{3}{4}$	PG21
	PG29-100	1	PG29
	PG29-125	$1\frac{1}{4}$	PG29
	PG36-125	$1\frac{1}{4}$	PG36
	PG36-150	$1\frac{1}{2}$	PG36
PG42-200	2	PG42	

Supplied standard with all hoods and bases.
Special sizes/hood combinations available.

Metric ISO-to-NPT thread adapters

	Cat. no.	NPT thread (mating) (in.)	Thread (at housing)
	M20-50	$\frac{1}{2}$	M20
	M20-75	$\frac{3}{4}$	M25
	M32-100	1	M32

Metric cord grip connectors

	Cat. no.	Cable O.D. (in.)		Thread (at housing)
		Min.	Max.	
	CG11-38	0.200	0.470	PG11
	CG11-38P*	0.325	0.340	PG11
	CG135-50	0.285	0.545	PG13.5
	CG16-50	0.285	0.625	PG16
	CG21-75	0.395	0.790	PG21
	CG29-100	0.780	0.060	PG291

Standard European style – Can be specified/
supplied with hoods and bases.

* Plastic

Technical information

Conduit entry blind plug & non-metallic cord grip fittings

Conduit entry blind plug

	Cat. no.	Thread (at housing)
	CXP722	PG13.5
	CXP723	PG16
	CXP724	PG21
	CXP725	PG29

Non-metallic cord grip fittings

	NPT threads		Cord range	
	Cat. no.	In.	mm	Thread size (in.)
	CC-NPT38-G	0.197-0.394	5-10	$\frac{3}{8}$
	CC-NPT12-G	0.394-0.551	10-14	$\frac{1}{2}$
	CC-NPT34-G	0.512-0.709	13-18	$\frac{3}{4}$
	CC-NPT1-G	0.709-0.984	18-25	1

	PG threads		Cord range	
	Cat. no.	In.	mm	Thread size (in.)
	CC-PG11-G	0.197-0.394	5-10	11
	CC-PG135-G	0.336-0.473	6-12	13.5
	CC-PG16-G	0.394-0.551	10-14	16
	CC-PG21-G	0.512-0.709	13-18	21
	CC-PG29-G	0.709-0.984	18-25	29
	CC-PG36-G	0.867-1.260	22-32	36

Technical information

Instructions for connection with fiber optic (POF Cable)

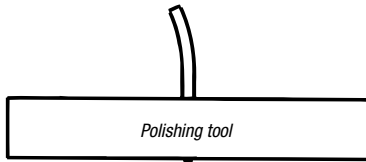

1) Before crimping the POF* cable, 1.0 mm to the glass fiber cable contact, the end of the fiber has to be polished. Stick end of POF cable into polishing tool and grind on a plane surface (e.g. glass plate). Wipe off any residues after polishing. The best optical damping values are achieved with wet-polishing-procedure.

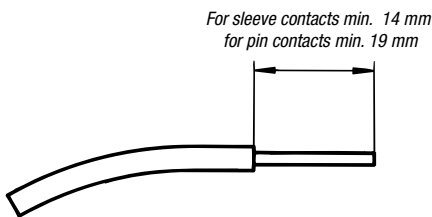

2) Strip 1.0 mm POF cable on min. 14 mm for D sleeve contacts and min. 19 mm for D pin contacts.

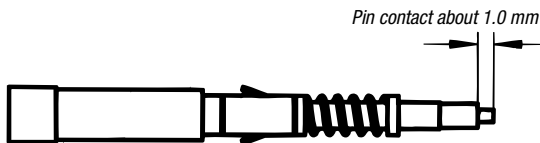

3) Insert stripped POF cable in sleeve or pin contact until stop. The optical fiber should then stick about 1 mm out of the contact.

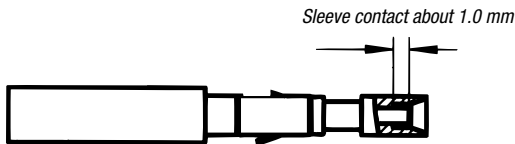

4) Optical fiber crimping:

Adjust the positioning sleeve into the corresponding inlet of the crimping tool with the stop screw at 1.45 mm (if necessary check with gauge pin, diameter 1.45 mm, with closed crimping tool).

Insert the glass fiber cable contact together with the POF cable through the crimp opening of the crimping tool into the positioning sleeve.

By pressure on the contact, the fiber inside the contact will be locked into the right position for the fiber crimping. Continue pressure until the release mechanism is heard.

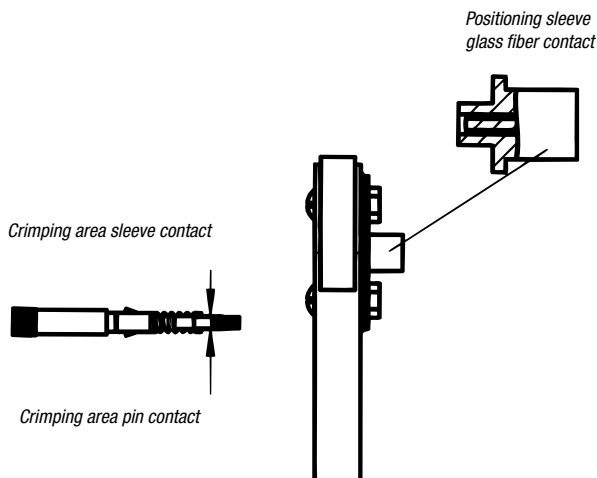

* POF = Polymer optical fiber

—
E

Alphanumeric index



E

Alphanumeric index

Alphanumeric index

Part. No.	Page	Part. No.	Page	Part. No.	Page
11732	B65, B70	21738	B65, B70	14RB-10	B13, B54, B55
11733	B65, B70	21739	B65, B70	14RB-10CP	B53
11734	B65, B70	21740	B65, B70	14RB-10F	B26, B54, B55
11735	B65, B70	21741	B65, B70	14RB-10FCP	B53
11736	B65, B70	25000	B64	14RB-10FL	B28
11737	B65, B70	10-401	A21	14RB-10FLX	B28
11738	B65, B70	10-405	A21	14RB-10FX	B27
11739	B65, B70	10-407	A21	14RB-10X	B14
11740	B65, B70	10-411	A21	14RB-14	B13
11771	B65, B70	10-415	A21	14RB-14F	B26
11802	B60, B70	10-417	A21	14RB-14X	B14
11803	B60, B70	10-421	A21	14RB-250F	B39, B53, B55
11805	B60, B70	10-425	A21	14RB-250FCP	B53
11806	B60, B70	10-427	A21	14RB-250T	B43
11807	B60, B70	10RC-10	B13, B54, B55	14RB-251T	B43
11808	B60, B70	10RC-10CP	B53	14RB-2577	B39
11809	B60, B70	10RC-10F	B26, B54	14RB-38	B13, B14
11810	B60, B70	10RC-10FCP	B53	14RB-38X	B14
11811	B60, B70	10RC-10FL	B28, B55	14RB-4	B13
11821	B60, B70	10RC-10FLX	B28	14RB-47PT	B30
11822	B60, B70	10RC-10FX	B27	14RB-4X	B14
11823	B60, B70	10RC-10X	B14	14RB-516	B13
11824	B60, B70	10RC-14	B13	14RB-516X	B28
11825	B60, B70	10RC-14CP	B53	14RB-6	B13
11826	B60, B70	10RC-14F	B26	14RB-6CP	B53
11827	B60, B70	10RC-14FL	B28	14RB-6F	B26
11828	B60, B70	10RC-14FLX	B28	14RB-6FCP	B53
11829	B60, B70	10RC-14FX	B27	14RB-6FL	B28
12050	B8, B56, B61	10RC-14X	B14	14RB-6FLX	B26
12051	B61, B69	10RC-250F	B39, B55	14RB-6FS	B26
12052	B61, B69	10RC-250FCP	B53	14RB-6FX	B27
12054	B61, B69	10RC-250T	B43	14RB-6X	B14
12055	B61, B69	10RC-251T	B43	14RB-8	B7, B13, B55
12056	B61, B69	10RC-2577	B39	14RB-8CP	B53
12057	B61, B69	10RC-38	B13	14RB-8F	B26, B55
12058	B61, B69	10RC-38X	B14	14RB-8FCP	B53
12059	B61, B69	10RC-516	B13	14RB-8FL	B28, B55
12060	B61, B69	10RC-516X	B14	14RB-8FLX	B28
12061	B61	10RC-55PT	B30	14RB-8FX	B27
12062	B61	10RC-6	B13	14RB-8X	B14
13400	B65, B70	10RC-6F	B26	14RBC-10	B18
13600	B66, B67	10RC-6FL	B28	14RBC-12	B18
13611	B67	10RC-6FLX	B28	14RBC-14	B18
13612	B67	10RC-6X	B14	14RBC-38	B18
13618	B67	10RC-8	B13	14RBC-516	B18
13619	B67	10RC-8F	B7, B26, B55	14RBC-6	B18
13620	B66, B67	10RC-8FCP	B53	14RBC-8	B18
13643	B65, B70	10RC-8FL	B28	14RBD-182	B41
13644	B65, B70	10RC-8FLX	B28	14RBD-18277	B42
13645	B65, B70	10RC-8FX	B27	14RBD-183	B41
13650	B65, B70	10RC-8X	B14	14RBD-18377	B42
13654	B65, B70	10RC-8X	B14	14RBD-187	B43
13655	B65, B70	10RC-8X	B14	14RBD-188	B43
13656	B65, B70	10RC-8X	B14	14RBD-188	B43
13657	B65, B70	10RC-8X	B14	14RBD-188	B43
13658	B65, B70	10RC-8X	B14	14RBD-188	B43
13659	B65, B70	10RC-8X	B14	14RBD-188	B43
13810	B67	10RC-8X	B14	14RBD-188	B43
21731	B65, B70	10RC-8X	B14	14RBD-188	B43
21732	B65, B70	10RC-8X	B14	14RBD-188	B43
21733	B65, B70	10RC-8X	B14	14RBD-188	B43
21734	B65, B70	10RC-8X	B14	14RBD-188	B43
21735	B65, B70	10RC-8X	B14	14RBD-188	B43
21736	B65, B70	10RC-8X	B14	14RBD-188	B43
21737	B65, B70	10RC-8X	B14	14RBD-188	B43

Part. No.	Page	Part. No.	Page	Part. No.	Page
18RA-250FCP	B53	2RC10X	B31, B55	833-JAR1000	A9
18RA-250T	B43	2RC10XCP	B53	833-JAR200	A9
18RA-251T	B43	2RCC	B31	833-JAR400	A9
18RA-2577	B39	2RCS10X	B38	833KP	A9
18RA-38	B13	2RD8	B31	833M	A7, B9
18RA-38X	B14	2RE6	B31	833P	A9
18RA-4	B13	2RF4	B31	A04XFGP	D59
18RA-47PT	B30	2RZZ	B31	A04XMEC	D59
18RA-4X	B14	2SHD	A17	A10-TB	B44
18RA-516	B13	2SHI	A17	A10XFGP	D59
18RA-6	B13	2SHP	A17	A10XMEC	D59
18RA-6F	B26	30BK	A15	A11	B44
18RA-6FCP	B53	30BP	A15	A114	B27
18RA-6FL	B28, B55	30P	A15	A115-TB	B27
18RA-6FLX	B28	31BK	A15	A116	B27
18RA-6FX	B27	31D	A15	A16XFGP	D59
18RA-6X	B14	31M	A15	A16XMEC	D59
18RA-8	B13, B55	31P	A15	A18-10	B15
18RA-8CP	B53	329BK	A11	A18-10F	B27
18RA-8F	B26, B55	329BP	A11	A18-10FL	B29
18RA-8FCP	B53	329P	A11	A18-110F	B44
18RA-8FL	B28	330BK	A11	A18-111F	B44
18RA-8FLX	B28	330BP	A11	A18-12	B15
18RA-8FX	B27	330P	A11	A18-14	B15
18RA-8X	B14	331BAR	A11	A18-250	B40
18RAD-182	B41	331BK	A11	A18-250A	B40
18RAD-18277	B42	331D	A11	A18-250T	B43
18RAD-183	B41	331KP	A11	A18-251T	B43
18RAD-18377	B42	331M	A11	A18-38	B15
18RAD-187	B43	331P	A11	A18-4	B15
18RAD-188	B43	333BAR	A11	A18-516	B15
18RAS-251TX	B38	333BK	A11	A18-6	B15
1SHD	A17	333D	A11	A18-6F	B27
1SHI	A17	333KP	A11	A18-6FL	B29
1SHP	A17	333M	A11	A18-8	B15
21707M	B65, B70	333P	A11	A18-8F	B27
21708M	B65, B70	335B	A11	A18-8FL	B29
21709M	B65, B70	335BK	A11	A18-PS-M	B33
21710M	B65, B70	335D	A11	A221	B29
21711M	B65, B70	335P	A11	A224	B29
21712M	B65, B70	335Q	A11	A225	B29
21713M	B65, B70	33BK	A15	A250-TB	B40
21714M	B65, B70	33D	A11	A251	B43
21715M	B65, B70	33P	A11	A252G	B40
2A-18	B32	35BK	A15	A32XFGP	D59
2A20	B33	35D	A11	A32XMEC	D59
2B-14	B32	35P	A11	A47PT	B30
2B-16	B33	35Q	A15	A480	B22
2C-10	B32	63D	A19	A481	B22
2C-12	B33	63P	A19	A482	B22
2D-8	B32	65 U	C28	A483	B22
2E-6	B32	65D	A19	A484	B22
2F-4	B32	65P	A19	A485	B22
2G21	B32	739B	A13	A486	B22
2RA18	B31	739C	A9	A71	B15
2RA18X	B7, B31, B55	739KP	A13	A72	B15
2RA18XCP	B53	739P	A13	A73	B15
2RAA	B31	739Q	A13	A75	B15
2RAS18X	B38	822BAR	A11	A85	B15
2RB14	B31	822BK	A11	A86	B15
2RB14X	B31, B55	822D	A11	A87	B15
2RB14XCP	B53	822Q	A11	AA2	B32
2RBB	B31	833BAR	A7, B9	AB14-10A	B23
2RBS14X	B38	833BK	A7, B9	AB14-6A	B23
2RC10	B31	833D	A9	AB14-8A	B23

Alphanumeric index

Part. No.	Page
AB51	B23
AB52	B23
AB53	B23
AC 5 X 3	C21
AC 5 X 7	C21
AC 85 X 105	C21
AC 85 X 75	C21
AD18-182	B42
AD18-183	B42
AD182	B42
AD183	B42
B10-TB	B44
B10XFGP	D59
B10XMEC	D59
B115	B27
B11-TB	B44
B132	B15
B133	B15
B134	B15
B14-10	B15
B14-10F	B27
B14-10FL	B29
B14-110F	B27
B14-111F	B44
B14-12	B15
B14-14	B15
B14-14F	B27
B14-250	B28
B14-250A	B40
B14-250F	B40
B14-250T	B40
B14-251T	B43
B14-38	B15
B14-4	B15
B14-516	B15
B14-6	B15
B14-6F	B27
B14-6FL	B29
B14-8	B15
B14-8F	B27
B14-8FL	B29
B14-D	B45
B14-PS-M	B33
B16XFGP	D59
B16XMEC	D59
B19	B27
B220	B29
B223	B29
B225	B29
B23	B45
B24XFGP	D59
B24XMEC	D59
B250	B40
B250G	B40
B251	B43
B252G	B40
B32XFGP	D59
B32XMEC	D59
B47PT	B30
B480	B22
B481	B22
B482	B22
B483	B22
B484	B22
B485	B22

Part. No.	Page
B486	B22
B48XFGP	D59
B48XMEC	D59
B64	B27
B65-TB	B27
B6XFGP	D59
B6XMEC	D59
B71	B15
B72	B15
B73	B15
B75-TB	B15
B85	B15
B86	B15
B87	B15
BAIR22-6	B63, B64, B69
BAT22-6NV2	B62, B69
BB010EH075MV	D29
BB010EH100MV	D19, D29, D49
BB010EMV	D19, D29
BB010MVEH075	D19
BB010TMV	D39
BB016EH100MV	D19, D23, D25, D29
BB016EMV	D19, D23, D25, D29
BB016TMV	D39
BB024EH100MV	D21, D27, D31, D33
BB024EMV	D21, D27, D31, D33
BB024TMV	D39
BB032AMV	D17, D27
BB032MV	D21, D23, D27, D31
BB110EH075MV	D19, D29
BB110EH100MV	D19, D29
BB110EMV	D19, D29
BB110TMV	D39
BB116EH100MV	D19, D23, D25, D29
BB116EMV	D19, D23, D25, D29
BB116TMV	D39
BB124EH100MV	D21, D27, D31, D33
BB124EMV	D21, D27, D31, D33
BB124TMV	D39
BB132A100	D17, D27
BB132AMV	D17, D27
BB132MV	D21, D23, D27, D31
BB2	B32
BB210H075MV	D19, D29
BB210H100MV	D19, D29
BB210MV	D19, D29
BB216H100MV	D19, D23, D25, D29
BB216MV	D19, D23, D25, D29
BB224H100MV	D21, D27, D31
BB224MV	D21, D27, D31, D33
BB232A100MV	D17, D27
BB232AMV	D17, D27
BB310H075MV	D19, D29
BB310H100MV	D19, D29
BB310MV	D19, D29
BB316H100MV	D19, D23, D25, D29
BB316MV	D19, D23, D25, D29
BB324H100MV	D21, D27, D31
BB324MV	D21, D27, D31, D33
BB332A	D17, D27
BB332A100	D17, D27
BB403APMV	D17, D25
BB406H100MV	D19, D29
BB406MV	D19, D29
BB406MVH075	D19, D29

Part. No.	Page
BB406TMV	D39
BB410AMV	D17, D25
BB410H075MV	D29
BB410H100MV	D29
BB410MV	D19, D29
BB410MVH075	D19
BB410MVH100	D19
BB416AMV	D17, D25
BB416H100MV	D19, D23, D25, D29
BB416MV	D19, D23, D25, D29
BB424H100MV	D21, D27, D31, D33
BB424MV	D21, D27, D31, D33
BB448MV	D21, D27, D31, D33, D37
BB506H075MV	D19, D29
BB506H100	D19, D29
BB506MV	D19, D29
BB506TMV	D39
BB510AMV	D17, D25
BB510H075MV	D19, D29
BB510H100	D19, D29
BB510MV	D19, D29
BB516AMV	D17, D25
BB516H100MV	D19, D23, D25, D29
BB516MV	D19, D23, D25, D29
BB524H100MV	D21, D27, D31, D33
BB524MV	D21, D27, D31, D33
BB548MV	D21, D27, D31, D33, D37
BB606H075MV	D19, D29
BB606H100	D19, D29
BB606MV	D19, D29
BB610AMV	D17, D25
BB610H075MV	D19, D29
BB610H100MV	D19, D29
BB610MV	D19, D29
BB616AMV	D17, D25
BB616H100MV	D23, D25, D29
BB616MV	D19, D23, D25, D29
BB616MVH100	D19
BB624H100MV	D21, D31, D33
BB624MV	D21, D31, D33
BB642	D27
BB642H100	D27
BB648MV	D21, D27, D31, D33, D37
BB706H075	D19, D29
BB706H100	D19, D29
BB706MV	D19, D29
BB710AMV	D17, D25
BB710H075MV	D19, D29
BB710H100MV	D19, D29
BB710MV	D19, D29
BB716AMV	D17, D25
BB716H100MV	D19, D23, D25, D29
BB716MV	D19, D23, D25, D29
BB724H100MV	D21, D27, D31, D33
BB724MV	D21, D27, D31, D33
BB748MV	D21, D27, D31, D33, D37
BB832A	D17, D27
BB832AMV	D27
BC14-10	B19
BC14-12	B19
BC14-14	B19
BC14-38	B19
BC14-516	B19
BC14-6	B19
BC14-8	B19

Part. No.	Page	Part. No.	Page	Part. No.	Page
BC71	B19	CC-PG11-G	D62	CPO187-0-6	C13, C15
BC72	B19	CC-PG135-G	D62	CPO2000	C13
BC75	B19	CC-PG16-G	D62	CPO250-0-6	C13, C15
BC79	B19	CC-PG21-G	D62	CPO375-0-6	C13, C15
BC85	B19	CC-PG29-G	D62	CPO500-0-6	C13, C15
BC86	B19	CC-PG36-G	D62	CPO63-0-6	C13
BC87	B19	CG11-38	D61	CPO750-0-6	C13, C15
BD14-182	B42	CG11-38P	D61	CPO93-0-6	C13
BD14-183	B42	CG135-50	D61	CPO-A-125-48	C17
BD183	B42	CG16-50	D61	CPO-A-187-48	C17
C10-10	B15	CG21-75	D61	CPO-A-250-48	C17
C10-10A	B23	CG29-100	D61	CPO-A-375-48	C17
C10-10F	B27	CH610E	D19, D29, D56	CPO-A-500-48	C17
C10-10FL	B29	CH610EH075MV	D19, D29	CPOA-750-48	C17
C10-12	B15	CH610EH100MV	D19, D29	CXP722	D62
C10-14	B15	CH610T	D39	CXP723	D62
C10-14F	B27	CH616EHMV	D19, D23, D25, D29	CXP724	D62
C10-14FL	B29	CH616TMV	D39	CXP725	D62
C10-250A	B40	CH624EMV	D21, D27, D31, D33	D10161	B17
C10-250F	B40	CH624T	D39	D10361	B17
C10-251T	B43	CH632MV	D21, D23, D27, D31	D10711	B17
C10-38	B15	CH716EHMV	D19, D23, D25, D29	D10721	B17
C10-516	B15	CH716T	D39	D10731	B17
C10-6F	B27	CH724EMV	D21, D27, D31, D33	D226	B23
C10-6FL	B29	CH724ERCMV	D21, D27	D236	B23
C10-6-SK	B15	CH724T	D39	D26	B16
C10-8A	B23	CH732MV	D21, D23, D27, D31	D271	B23
C10-8F	B27	CH803APMV	D17, D25	D36	B16
C10-8FL	B29	CH806	D29	D65 U	C28
C10-8-SK	B15	CH806H075MV	D19, D29	D71	B16
C10-PS-D	B33	CH806H100MV	D19, D29	D72	B16
C114	B27	CH806HVMV	D19	D73	B16
C115	B27	CH806T	D39	D75	B16
C116-TB	B27	CH810	D29	D8-10	B16
C133	B27	CH810AMV	D17, D25	D8-12	B16
C220-TB	B29	CH810EMV	D19	D8-14-SK	B16
C221	B30	CH810H075MV	D19, D29	D8-38	B16
C222-TB	B29	CH810H100MV	D19, D29	D8-516	B16
C250	B40	CH816AMV	D17, D25	D8-PS-D	B33
C252G	B40	CH816HVMV	D19, D23, D25, D29	D975	B17
C26	B15	CH824MV	D21, D27, D31, D33	DD102	B32
C33	B15	CH916HVMV	D19, D23, D25, D29	DIE1806	B62
C36	B15	CH924MV	D21, D27, D31, D33	DIE2001	B62, B63, B64, B69
C480	B22	CHS100	C18	DIE2002	B62, B63, B64, B69
C481	B22	CHS100B	C18	DIE2005	B62, B63, B64, B65
C482	B22	CHS112	C18	DIE2007	B62, B63, B64
C483	B22	CHS112B	C18	DIE2009	B62, B69
C484	B22	CHS12	C18	DIE2500	B62
C485	B22	CHS12B	C18	DT22-10	B47
C486	B22	CHS14	C18	E10261	B17
C51	B23	CHS14B	C18	E10711	B17
C52-TB	B23	CHS18	C18	E10721	B17
C53	B23	CHS18B	C18	E10731	B17
C55PT	B30	CHS200	C18	E226	B23
C70	B15	CHS200B	C18	E26	B16
C71	B15	CHS34	C18	E271	B23
C72	B19	CHS34B	C18	E272	B23
C73	B15	CHS38	C18	E6-10	B16
C75	B15	CHS38B	C18	E6-12	B16
C77	B15	CHS-KIT	C14	E6-14	B16
CC2-TB	B32	CM2000A	B83	E6-38	B16
CC-NPT12-G	D62	CPO1000-0-6	C13, C15	E6-516	B16
CC-NPT1-G	D62	CPO1250	C13	E6-PS-D	B33
CC-NPT34-G	D62	CPO125-0-6	C13	E71	B16
CC-NPT38-G	D62	CPO1500	C13	E72	B16

Alphanumeric index

Part. No.	Page	Part. No.	Page	Part. No.	Page
E73	B16	F4007	B48, B50	F9034	B52
E75	B16	F4008	B48, B50	F9035	B52
EE2	B32	F4009	B48, B50	F9036	B52
ERG1-WS	B60, B83	F4020	B50, B51	F9037	B52
ERG4	B51	F4021	B50, B51	F9038	B52
ERG4001	B58	F4022	B50	F9039	B52
ERG4002	B58	F4023	B50, B51	F975	B17
ERG4004	B58	F4024	B50, B51	FC108DD	D30
ERG4005	B58	F4027	B50, B51	FC116DD	D30
ERG4006	B58	F4028	B50, B51	FC124DD	D28
ERG4007	B58	F4-10	B16	FC142DD	D28
ERG4008	B17, B58, B70	F4-12	B16	FC144DD	D30
ERG4255	B37, B38, B59	F4-14	B16	FC172DD	D28, D30
F10261	B17	F4-38	B16	FC307D	D24
F10711	B17	F4-516	B16	FC308D	D24
F10721	B17	F4-PS-W	B33	FC315D	D24
F10731	B17	F71-TB	B16	FC316B	D20
F2020	B48, B50	F72	B16	FC324B	D20
F2021	B48, B50	F73	B16	FC325D	D24, D26
F2022	B48, B50	F75	B16	FC332B	D20
F2023	B48, B50	F8000	B51	FC340D	D24, D26
F2024	B48, B50	F8001	B51	FC348B	D20
F2025	B48, B50	F8002	B51	FC364D	D26
F2026	B48, B50	F8003	B51	FF2	B23
F2027	B48, B50	F8005	B51	FP14SD	D24, D26, D28, D30
F2028	B48, B50	F8006	B51	FP16SD	D24, D26, D28, D30
F2029	B48, B50	F8007	B51	FP18SD	D24, D26, D28, D30
F2030	B48, B50	F8008	B51	FP20SD	D24, D26, D28, D30
F2031	B49, B50	F8009	B51	FP22SD	D24, D26, D28, D30
F2032	B49, B50	F8010	B51	FS103A	D16
F2033	B49, B50	F8011	B51	FS103V	D34
F2034	B49, B50	F9000	B52	FS104A	D16
F2035	B49, B50	F9001	B52	FS106C	D22
F2036	B49, B50	F9002	B52	FS106T	D38
F2037	B49, B50	F9003	B52	FS106V	D34
F2038	B49, B50	F9004	B52	FS106WAL	D18, D52
F2039	B49, B50	F9005	B52	FS106WAR	D52
F2040	B49, B50	F9006	B52	FS110A	D16
F2041	B49, B50	F9007	B52	FS110B	D18
F2042	B49, B50	F9008	B52	FS110T	D38
F2043	B49, B50	F9009	B52	FS110V	D36
F2044	B49, B50	F9010	B52	FS110WAL	D18, D52
F2045	B49, B50	F9011	B52	FS110WAR	D52
F2046	B49, B50	F9012	B52	FS112C	D22
F2047	B49, B50	F9013	B52	FS112K	D32
F2048	B49, B50	F9014	B52	FS116A	D16
F2049	B49, B50	F9015	B52	FS116B	D18, D20
F2050	B49, B50	F9016	B52	FS116T	D38
F2051	B49	F9017	B52	FS116V	D36
F2052	B49	F9018	B52	FS116WAL	D18, D52
F2053	B49	F9019	B52	FS116WAR	D52
F2054	B49, B50	F9020	B52	FS124B	D18
F226	B23	F9021	B52	FS124T	D38
F250TA	B44	F9022	B52	FS124WAL	D20, D52
F26	B16	F9023	B52	FS124WAR	D52
F271	B23	F9024	B52	FS132A	D16
F272	B23	F9025	B52	FS132B	D20
F273	B23	F9026	B52	FS148B	D20
F4000	B50, B51	F9027	B52	FS340WAL	D24, D52
F4001	B50, B51	F9028	B52	FS364WAL	D52
F4002	B50, B51	F9029	B52	FTA250	B44
F4003	B50, B51	F9030	B52	G2051	B50
F4004	B48, B50	F9031	B52	G2052	B50
F4005	B48, B50	F9032	B52	G2053	B50
F4006	B48, B50	F9033	B52	G2-12	B17

Part. No.	Page	Part. No.	Page	Part. No.	Page
G2-14	B17	HSC2-20	C10	K975	B17
G2-38	B17	HSC300	C10	L4/0-PS-L	B33
G2-516	B17	HSC300-600	C10	L40-38	B17
G2-PS-W	B33	HSC30-250	C10	L971	B17
G671	B23	HSC500	C10	L972	B17
G672	B23	HSC700-1000	C10	L973	B17
G673	B23	HSC750	C10	L974	B17
G926	B17	HSC8-4	C10	L975	B17
G971	B17	HSFR12-6-4	C9	LD2	B46
G972	B17	HSFR16-12-4	C9	LD2-C	A23, B47
G973	B17	HSFR40-400-4	C9	LD2C-D	A23
G975	B17	HSFR4-30-4	C9	LD2-D	B46
GG2	B32	HSFR500-1000-4	C9	LD2P-D	B46
H1/0-PS-C	B33	HSFR6-1-4	C9	LD2P-Q	B46
H10-14	B17	HSR1300-4	C8	LD3	B46
H672	B23	HSR1750-4	C8	LD3-C	A23, B47
H673	B23	HSR2000-4	C8	LD3C-D	A23
H971	B17	HSR2750-4	C8	LD3-D	B46
H972	B17	HSR3500-4	C8	LH010EH075MV	D19, D29
H973	B17	HSR4700-4	C8	LH010EH100MV	D19, D29
H975	B17	HSR750-4	C8	LH010EMV	D19, D29
HS12-30	C7	HS-KIT	C13	LH016EMV	D19, D23, D25, D29
HS12-40	C7	HSMW1100-48	C12	LH024EMV	D21, D27, D31
HS12-6	C7	HSMW1300-48	C12	LH032AMV	D17, D27, D33
HS12-6-25	C7	HSMW1500-48	C12	LH116EHMV	D19, D23, D25, D29
HS12-6-4	C7	HSMW1700-48	C12	LH124EMV	D21, D27, D31
HS12-6L	C7	HSMW2050-48	C12	LH132AMV	D17, D27, D33
HS12-6LR	C7	HSMW2750-48	C12	LH210EH075MV	D19, D29
HS16-12	C7	HSMW3500-48	C12	LH210EH100MV	D19, D29
HS16-12-25	C7	HSMW400-48	C12	LH210EMV	D19, D29
HS16-12-4	C7	HSMW4700-48	C12	LH216E	D19, D23, D25, D29
HS16-12L	C7	HSMW6700-48	C12	LH224E	D21, D27, D31
HS30-30	C7	HSMW750-48	C12	LH232AMV	D17, D27, D33
HS30-4	C7	HSMW9000-48	C12	LH316EHMV	D19, D23, D25, D29
HS30-40	C7	HT1000C	C20	LH324EMV	D21, D27, D31
HS40-400	C7	HT1000C-L	C20	LH332AMV	D17, D27, D33
HS40-400-25	C7	HT20C	C20	M20-50	D61
HS40-400-4	C7	HT40C	C20	M20-75	D61
HS40-400L	C7	HT600C	C20	M250-38	B17
HS40-4-TB	C7	HTC1000	C19	M250-PS-Q	B33
HS4-30	C7	HTC1000L	C19	M32-100	D61
HS4-30-25	C7	HTC2	C19	M673	B23
HS4-30-4	C7	HTC2S	C19	M675	B23
HS4-30L	C7	HTC40	C19	M972	B17
HS4-30LR	C7	HTC500	C19	M973	B19
HS500-1000	C7	J2/0-PS-C	B33	M974	B17
HS500-1000-25	C7	J20-38	B17	M975	B17
HS500-1000-4	C7	J672	B23	MC208DD	D30
HS500-1000L	C7	J673	B23	MC216DD	D30
HS6-1	C7	J675	B23	MC224DD	D28
HS6-1-25	C7	J971	B17	MC242DD	D28
HS6-1-4	C7	J972	B17	MC244DD	D30
HS6-1L	C7	J973	B17	MC272DD	D28, D30
HS6-1LR	C7	J974	B17	MC407D	D24
HSB120-50-3	C11	J975	B17	MC408D	D24
HSB125-50-4	C11	J976	B17	MC415D	D24
HSB170-82-3	C9	K3/0-PS-L	B33	MC416B	D20
HSB175-82-4	C11	K30-38	B17	MC424B	D20
HSB200-75-2	C11	K672	B23	MC425D	D24, D26
HSB240-112-3	C11	K673	B23	MC432B	D20
HSB265-120-4	C11	K675	B23	MC440D	D24, D26
HSB350-138-3	C11	K971	B17	MC448B	D20
HSB430-157-3	C11	K972	B23	MC464D	D26
HSB490-200-3	C11	K973	B17	MP14SD	D24, D26, D28, D30
HSB520-135-4	C11	K974	B17	MP16SD	D24, D26, D28, D30

Alphanumeric index

Part. No.	Page	Part. No.	Page	Part. No.	Page
MP18SD	D24, D26, D28, D30	PB303A	D17, D25, D49	RA18-6F	B24
MP20SD	D24, D26, D28, D30	PB306	D19, D29, D49	RA18-6FL	B25
MP22SD	D24, D26, D28, D30	PB306T	D39	RA18-6FS	B26
MS203A	D16	PB310	D19, D29, D49	RA18-8	B8
MS203V	D34	PB310A	D17, D25, D49	RA18-8F	B24
MS204A	D16	PB316	D19, D23, D25, D29, D49	RA18-8FL	B25
MS206B	D18	PB316A	D17, D25, D49	RA18-8FS	B26
MS206C	D22	PB324	D21, D27, D31, D33, D49	RA18D	B45
MS206T	D38	PB348	D21, D27, D31, D33, D37, D49	RA2213	B25
MS206V	D34	PB403A	D17, D25, D49	RA2217	B28
MS206WAL	D52	PB406	D19, D29, D49	RA2217-170	B28
MS206WAR	D52	PB410	D19, D29	RA2227	B28
MS210A	D16	PB410A	D17, D25, D49	RA2243	B25
MS210B	D18	PB416	D19, D23, D25, D29, D49	RA2247	B28
MS210T	D38	PB416A	D17, D25, D49	RA2253	B25
MS210V	D36	PB424	D21, D27, D31, D33, D49	RA2257	B28
MS210WAL	D52	PB448	D21, D31, D37, D49	RA2257-170	B28
MS210WAR	D52	PB503A	D17, D25, D49	RA23	B45
MS212C	D22	PG11-38	D61	RA250P	B41
MS212K	D32	PG16-50	D61	RA250-TB	B39
MS216A	D16	PG21-75	D61	RA2517	B43
MS216B	D18, D20	PG29-100	D61	RA25177	B43
MS216T	D38	PG36-125	D61	RA257	B39
MS216V	D36	PG36-150	D61	RA257-170	B39
MS216WAL	D52	PG42-200	D61	RA2573	B39
MS216WAR	D52	PT60M	B35	RA2577F	B40
MS224B	D20	PT66M	B35	RA28	B91
MS224T	D38	PT6M	B35	RA28V	B93
MS224WAL	D52	PT70	B35	RA29	B91
MS224WAR	D52	PT70M	B35	RA29V	B91
MS232A	D16	PT80	B35	RA323	B8
MS232B	D20	RS00-PS-V	B33	RA333	B8
MS440WAL	D24, D52	RA10-SK	B44	RA35F	B85
MS464WAL	D52	RA11	B44	RA3RR	B84
MSC14	C24	RA1103	B24	RA47PT	B30
MSC2	C24	RA1123	B24	RA48	B91
MSC250	C24	RA1147	B26	RA480	B21
MSC500	C24	RA1147-170	B27	RA481	B21
MSC8	C24	RA1153	B24	RA482	B21
N300-PS-X	B33	RA1157	B26	RA483	B21
NW10-10	B20	RA1157-170	B27	RA484	B21
NW10-12	B20	RA1163	B24	RA485	B21
NW10-8	B20	RA1167	B26	RA486	B21
NW14-10	B20	RA1167-170	B27	RA48V	B93
NW14-12	B20	RA1203	B26	RA49	B91
NW14-8	B20	RA1223	B26	RA49V	B93
NW18-10	B20	RA1253	B26	RA4F	B85
NW52	B20	RA147PT	B30	RA4RR	B84
NW81	B20	RA18-10	B8	RA5F	B85
NW83	B20	RA18-10F	B24	RA5RR	B84
NW84	B20	RA18-10FL	B25	RA63	B91
P400-PS-X	B33	RA18-10FS	B26	RA63M	B92
PAIR22-6	B63, B64, B69	RA18-110F	B44	RA63V	B93
PB110E	D19, D29, D49	RA18-111F	B44	RA6F	B85
PB110T	D39	RA18-12	B8	RA6RR	B84
PB116E	D19, D23, D25, D29, D45	RA18-14	B8	RA713	B8
PB116T	D39	RA18-14F	B24	RA717	B13
PB124E	D21, D27, D31, D33, D49	RA18-250A	B40	RA723	B8
PB124T	D39	RA18-250F	B39	RA727	B13
PB132	D21, D23, D27, D31	RA18-250FP	B41	RA727-170	B14
PB132A	D17, D27, D49	RA18-38	B8	RA733	B8
PB210	D19, D29, D57	RA18-4	B8	RA737	B13
PB216	D19, D23, D25, D29, D57	RA18-47PT	B30	RA753	B8
PB224	D21, D27, D31, D33, D57	RA18-516	B8	RA77	B13
PB232A	D17, D27, D33	RA18-6	B8	RA833	B8

Part. No.	Page	Part. No.	Page	Part. No.	Page
RA853	B8	RB14-10	B9	RB481	B21
RA857	B13	RB14-10F	B24	RB482	B21
RA857-170	B14	RB14-10FL	B25	RB483	B21
RA863	B8	RB14-10FS	B26	RB484	B21
RA867	B13	RB14-10X	B18	RB485	B21
RA867-170	B14	RB14-110F	B44	RB486	B21
RA873	B8	RB14-111F	B44	RB48V	B93
RA877	B13	RB14-12	B9	RB49	B91
RA877-170	B14	RB14-14	B9	RB49V	B93
RAA15	B94	RB14-14F	B24	RB4-EU	B84
RAA21	B31	RB14-14X	B10	RB4F	B85
RAA217	B31	RB14-250	B44	RB4-HT	B36
RAA217-170	B31	RB14-250A	B40	RB4-TB	B34, B36
RAA23	B31	RB14-250F	B39	RB5	B84
RAA24	B33	RB14-250FP	B41	RB5F	B85
RAAS22X	B38	RB14-38	B9	RB6	B84
RAAT21	B32	RB14-38X	B10	RB63	B91
RAD18-182	B41	RB14-4	B9	RB63M	B92
RAD18-183	B41	RB14-47PT	B30	RB63V	B93
RAD18-187A	B42	RB14-4X	B10	RB647	B26
RAD18-188A	B42	RB14-516	B9	RB647-200	B27
RAD1823	B41	RB14-516X	B10	RB657	B26
RAD1827	B41	RB14-6	B9	RB657-200	B27
RAD18277	B42	RB14-6F	B24	RB6F	B85
RAD1833	B41	RB14-6FL	B25	RB713	B9
RAD1837	B41	RB14-6FS	B26	RB714	B10
RAD18377	B42	RB14-6X	B10	RB717	B13
RAD1877F	B42	RB147PT	B30	RB717-200	B14
RAD1887F	B42	RB14-8	B9	RB723	B9
RAP	B90	RB14-8F	B24	RB724	B10
RAS18-10FLX	B39	RB14-8FL	B25	RB727	B13
RAS18-10X	B37	RB14-8FS	B26	RB733	B9
RAS18-250AX	B38	RB14-8X	B10	RB734	B10
RAS18-6FLX	B39	RB14D	B45	RB737	B13
RAS18-6X	B37	RB1717	B26	RB753	B9
RAS18-8FLX	B37	RB2207	B28	RB8	B84
RAS18-8X	B37	RB2207-200	B28	RB853	B9
RAT713	B20	RB2213	B25	RB854	B10
RAT853	B19	RB2214	B25	RB857	B13
RAT863	B20	RB2217	B28	RB857-200	B14
RAT873	B20	RB2217-200	B28	RB863	B9
RAX103	B8	RB2233	B25	RB864	B10
RAX23	B8	RB2237	B28	RB867	B13
RAX43	B8	RB2237-200	B28	RB867-200	B14
RAX63	B8	RB2253	B25	RB873	B9
RAX83	B8	RB2254	B25	RB874	B10
RB10-SK	B44	RB2257	B28	RB877	B13
RB1103	B24	RB2257-200	B28	RB877-200	B14
RB1113	B24	RB23	B45	RB821	B31
RB1123	B24	RB250	B39	RBB217	B31
RB1124	B24	RB250P	B41	RBB217-200	B31, B55
RB1153	B24	RB2517	B43	RBB23	B31
RB1154	B24	RB25177	B43	RBB25	B33, B94
RB1157	B26	RB257	B39	RBB250	B44
RB1157-200	B27	RB257-200	B39	RBS522X	B38
RB1163	B24	RB2573	B39	RBBT21	B32
RB11-TB	B47	RB2577F	B40	RBC14-10	B18
RB1203	B26	RB3	B84	RBC14-12	B18
RB1204	B26	RB3F	B85	RBC14-14	B18
RB1223	B26	RB4-10M	B36	RBC14-38	B18
RB1224	B26	RB44	B34, B36	RBC14-516	B18
RB1253	B26	RB44-HT	B36	RBC14-6	B18
RB1323	B9	RB47PT	B30	RBC14-8	B18
RB1327	B13	RB48	B91	RBC713	B18
RB1333	B9	RB480	B21	RBC717	B18

Alphanumeric index

Part. No.	Page	Part. No.	Page	Part. No.	Page
RBC727	B18	RC1147-250	B27	RC714	B9
RBC753	B18	RC1153	B24	RC717	B13
RBC797	B18	RC1154	B24	RC717-250	B14
RBC857	B18	RC1157	B26	RC733	B9
RBC863	B18	RC1157-250	B27	RC734	B10
RBC867	B18	RC1163	B24	RC737	B13
RBC877	B18	RC1167	B26	RC737-250	B14
RBD14-182	B41	RC1223	B26	RC753	B9
RBD14-183	B41	RC1224	B26	RC777	B13
RBD14-187A	B42	RC1253	B26	RC777-250	B14
RBD14-188A	B42	RC1254	B26	RC8	B84
RBD1823	B41	RC1337	B26	RC863	B9
RBD1827	B41	RC155PT	B30	RC864	B10
RBD18277	B42	RC2203	B25	RC8F	B85
RBD1833	B41	RC2204	B25	RC95	B91
RBD1837	B41	RC2207	B27	RCC21	B31
RBD18377	B42	RC2207-250	B28	RCC217	B31
RBD1877F	B42	RC2213	B25	RCC217-250	B31
RBD1887F	B42	RC2217	B27	RCC26	B33
RBJ	B95	RC2223	B25	RCC6	B94
RBP	B90	RC2224	B25	RCCS22X	B38
RBS14-10FLX	B37	RC2227	B27	RCCT21	B32
RBS14-10X	B37	RC2227-250	B28	RCJ	B95
RBS14-250AX	B38	RC2233	B25	RCP	B90
RBS14-6FLX	B37	RC2237	B27	RCS10-10FLX	B37
RBS14-6X	B37	RC250	B39	RCS10-10X	B37
RBS14-8FLX	B37	RC2517	B43	RCS10-14FLX	B37
RBS14-8X	B37	RC25177	B43	RCS10-14X	B37
RBT713	B20	RC257	B39	RCS10-250AX	B38
RBT853	B20	RC2573	B39	RCS10-6FLX	B37
RBT863	B20	RC2577F	B40	RCS10-6X	B37
RBT873	B20	RC333	B9	RCS10-8FLX	B37
RC10-10	B9	RC334	B10	RCS10-8X	B37
RC10-10F	B24	RC337	B13	RCT333	B20
RC10-10FL	B25	RC337-250	B14	RCT363	B20
RC10-10FS	B26	RC363	B9	RCT703	B20
RC10-10X	B10	RC364	B10	RCT713	B20
RC10-12	B9	RC367	B13	RCT733	B20
RC10-12X	B10	RC367-250	B14	RCT863	B20
RC10-14	B9	RC4	B84	RD10161	B11
RC10-14F	B24	RC480	B21	RD10361	B11
RC10-14FL	B25	RC481	B21	RD10711	B11
RC10-14X	B10	RC482	B21	RD10721	B11
RC10-250A	B40	RC483	B21	RD10731	B11
RC10-250F	B39	RC484	B21	RD167	B11
RC10-38	B9	RC485	B21	RD367	B11
RC10-38X	B10	RC486	B21	RD717	B11
RC10-516	B9	RC4F	B85	RD727	B11
RC10-516X	B10	RC5	B84	RD737	B11
RC10-55PT	B30	RC55	B34, B36	RD757	B11
RC10-6	B9	RC551-HT	B36	RD8-10	B11
RC10-6F	B24	RC55PT	B30	RD8-12	B11
RC10-6FL	B25	RC5F	B85	RD8-14	B11
RC10-6X	B10	RC6	B36, B55, B59	RD8-38	B11
RC10-8	B9	RC63	B91	RD8-516	B11
RC10-8F	B24	RC63M	B92	RDD27	B31
RC10-8FL	B25	RC63V	B93	RDV167	B14
RC10-8FS	B26	RC6-5M	B36	RDV367	B14
RC10-8X	B10	RC6-EU	B84	RDV717	B14
RC10E	B84	RC6F	B85	RDV727	B14
RC10F	B85	RC6-HT	B36	RDV737	B14
RC1113	B24	RC703	B9	RDV757	B14
RC1123	B24	RC704	B9	RE10261	B11
RC1124	B24	RC707	B13	RE10711	B11
RC1147	B26	RC713	B9	RE10721	B11

Part. No.	Page	Part. No.	Page	Part. No.	Page
RE10731	B11	RL9751	B12	STAPOUCH-HS	B38
RE267	B11	RM737	B12	T1	B36
RE6-10	B11	RM747	B12	T10-10F-XV	B81
RE6-12	B11	RM757	B12	T10-10R-XV	B81
RE6-14	B11	RM9731	B12	T10-14F-XV	B81
RE6-38	B11	RM9751	B12	T10-14R-XV	B84
RE6-516	B11	RP12	B34	T10-8F-XV	B81
RE717	B11	RP-12	B36	T10-8R-XV	B81
RE727	B11	RP12-HT	B36	T14-10F-XV	B84
RE737	B11	RP7	B34, B36	T14-10R-XV	B81
RE757	B11	RP7-HT	B36	T14-8F-XV	B81
REE28	B31	RT614	D24, D26, D28, D30	T14-8R-XV	B84
REV267	B14	RZ22-10	B8	T18-10F-XV	B81
REV717	B14	RZ22-2	B8	T18-8F-XV	B81
REV727	B14	RZ22-4	B8	T3	B51
REV737	B14	RZ22-6	B8	TBFP9-2	C22, C23
REV757	B14	RZ22-8	B8	TBFT201-36	C22
RF10261	B11	RZ3	B84	TBFT421-12	C22
RF10711	B11	RZ3F	B85	TBFT421-36	C22
RF10721	B11	RZ4	B84	TBM6	B60, B64
RF10731	B11	RZ4F	B85	TBM6S	B60, B83
RF267	B11	RZ5	B84	TH203V	D35
RF4-10	B11	RZP	B90	TH206V	D35
RF4-14	B11	RZZ23	B31	TH210H075MV	D19, D29
RF4-38	B11	SH003V	D35	TH210H100MV	D19, D29
RF4-516	B11	SH006V	D35	TH210MV	D19, D29
RF717	B11	SH010H075MV	D19, D29	TH210T	D39
RF727	B11	SH010H100MV	D19, D29	TH216MV	D19, D23, D25, D29
RF737	B11	SH010MV	D19, D29	TH216T	D39
RF757	B11	SH010TMV	D39	TH224MV	D21, D27, D31, D33
RG2-10	B12	SH016MV	D19, D23, D25, D29	TH224T	D39
RG2-12	B12	SH016TMV	D39	TH232AMV	D17, D27
RG2-14	B12	SH024MV	D21, D27, D31, D33	TH232MV	D21, D23, D27, D31
RG2-38	B12	SH024TMV	D39	TH316HMMV	D19, D23, D25, D29
RG2-516	B12	SH032AMV	D17, D27	TH324MV	D21, D27, D31, D33
RG267	B12	SH032MV	D21, D23, D27, D31	TH324TMV	D39
RG717	B12	SH116HMMV	D19, D23, D25, D29	TH332125MV	D21, D23, D31
RG727	B12	SH124MV	D21, D27, D31, D33	TH332AMV	D17, D27
RG737	B12	SH124TMV	D39	TH332MV	D21, D23, D27, D31
RG757	B12	SH132125MV	D21, D23, D31	TH424RC	D27
RG9711	B12	SH132AMV	D17, D27	TH424RCMV	D21
RG9731	B12	SH132MV	D21, D23, D27, D31	TH624RC	D27
RG9751	B12	SH603APMV	D17, D25	TH803APMV	D17, D25
RH717	B12	SH603V	D35	TH803VMV	D35
RH727	B12	SH606H075MV	D19, D29	TH806H075MV	D19, D29
RH737	B12	SH606H100MV	D19, D29	TH806H100MV	D19, D29
RH757	B12	SH606MV	D19, D29	TH806MV	D19, D29
RH9711	B12	SH606T	D39	TH806T	D39
RH9731	B12	SH606VMV	D35	TH806VMV	D35
RH9751	B12	SH610AMV	D17, D25	TH810AMV	D17, D25
RJ717	B12	SH610H075MV	D19, D29	TH810H075MV	D19, D29
RJ727	B12	SH610H100MV	D19, D29	TH810H100MV	D19, D29
RJ737	B12	SH610MV	D19, D29	TH810MV	D19, D29
RJ757	B12	SH616AMV	D17, D25	TH816AMV	D17, D25
RJ9711	B12	SH616MV	D19, D23, D25, D29	TH816H100MV	D19, D23, D25, D29
RJ9731	B12	SH624MV	D21, D27, D31, D33	TH816MV	D19, D23, D25, D29
RJ9751	B12	SH648MV	D21, D27, D31, D33, D37	TH824MV	D21, D27, D31, D33
RK717	B12	SH710AMV	D17, D25	TH848MV	D21, D27, D31, D33
RK727	B12	SH716AMV	D17, D25	TH910AMV	D17, D25
RK737	B12	SH716HMMV	D19, D23, D25, D29	TH916AMV	D17, D25
RK9731	B12	SH724MV	D21, D27, D31, D33	TH924MV	D21, D27, D31, D33
RK9751	B12	SH748MV	D21, D27, D31, D33, D37	TH948	D27
RL737	B12	SK-CLASSIQUE	B55	TH948MV	D21, D31, D33, D37
RL757	B12	STAKIT	B55	TN10-WJ-XV	B80
RL9731	B12	STA-ORG	B54	TN14-WJ-XV	B80

Alphanumeric index

Part. No.	Page	Part. No.	Page	Part. No.	Page
TN18-WJ-XV	B80	TV10-250MD-XV	B80	VB-35BR	B86
TNF-10-250FDD-XV	B82	TV10-250PDD-XV	B81	VB-35RR	B86
TNF10-250FD-XV	B82	TV10-250PD-XV	B81	VB-3BF	B89
TNF-10-250MDD-XV	B82	TV10-6LFD-XV	B81	VB-3BR	B86
TNF-10-250MD-XV	B82	TV10-6LF-XV	B81	VB-3RR	B86
TNF-14-250FDD-XV	B82	TV10-8F-XV	B80	VB-4BF	B89
TNF14-250FD-XV	B82	TV10-8LFD-XV	B81	VB-4BR	B86
TNF-14-250MDD-XV	B82	TV10-8LF-XV	B81	VB-4RF	B89
TNF-14-250MD-XV	B82	TV10-8R-XV	B80	VB-4RR	B86
TNF14-4FB-XV	B82	TV10-BS-XV	B80	VB-4YF	B89
TNF14-4MB-XV	B82	TV14-00QS-V	B81	VB-4YR	B86
TNF-18-250FDD-XV	B82	TV14-10BL-XV	B80	VB-5BF	B89
TNF18-250FD-XV	B82	TV14-10F-XV	B80	VB-5BR	B86
TNF-18-250MDD-XV	B82	TV14-10LFD-XV	B81	VB-5RF	B89
TNF-18-250MD-XV	B82	TV14-10LF-XV	B81	VB-5RR	B86
TNF18-4FB-XV	B82	TV14-10R-XV	B80	VB-5YF	B89
TNF18-4MB-XV	B82	TV14-12PT-XV	B80	VB-5YR	B86
TOOL 331	A11	TV14-18BL-XV	B80	VB-6BF	B89
TOOL 333	A11	TV14-250FDD-XV	B81	VB-6BR	B86
TOOL 335	A11	TV14-250FD-XV	B80	VB-6RF	B89
TOOL-WING	A9, A13	TV-14-250MDD-XV	B82	VB-6RR	B86
TRA3	B87	TV14-250MD-XV	B80	VB-6YF	B89
TRA35	B87	TV14-250PDD-XV	B81	VB-6YR	B86
TRA35F	B88	TV14-250PD-XV	B81	VB-8BR	B86
TRA3F	B88	TV14-6F-XV	B80	VB-8RR	B86
TRA4	B87	TV14-6LFD-XV	B81	VB-8YF	B89
TRA4F	B88	TV14-6LF-XV	B81	VB-8YR	B86
TRA5	B87	TV14-6R-XV	B80	VBC-1	B60
TRA5F	B88	TV14-8F-XV	B80	WAM-1	D18, D20, D24
TRA6	B87	TV14-8LFD-XV	B81	WAM1AZ	D18, D20, D24
TRA6F	B88	TV14-8LF-XV	B81	WAM1B	D18, D20, D24
TRA8	B87	TV14-8R-XV	B80	WAM1N64	D18, D20, D24
TRB10	B87	TV14-BS-XV	B80	WT110M	B56
TRB3	B87	TV18-00QS-V	B81	WT111M	B56, B83
TRB35	B87	TV18-10BL-XV	B80	WT112M	B56
TRB35F	B88	TV18-10LFD-XV	B81	WT115A	B33, B60, B70
TRB3F	B88	TV18-10LF-XV	B81	WT129	B59
TRB4	B87	TV18-10R-XV	B80	WT1377	B59
TRB4F	B88	TV18-12PT-XV	B80	WT1400	C25
TRB5	B87	TV18-250FDD-XV	B81	WT161M	B35, B56, B68
TRB5F	B88	TV18-250FD-XV	B80	WT2000	B56
TRB6	B87	TV-18-250MDD-XV	B82	WT2130A	B59
TRB6F	B88	TV18-250MD-XV	B80	WT3185	B59, B70
TRB8	B87	TV18-250PDD-XV	B81	WT611TB	D16, D18, D20, D34, D36
TRC10	B87	TV18-250PD-XV	B81	WT80	D24, D26, D28, D30
TRC4-EU	B87	TV18-6F-XV	B80	WT-PTORCH	C25
TRC4F	B88	TV18-6LFD-XV	B81		
TRC5-EU	B87	TV18-6LF-XV	B81		
TRC5F	B88	TV18-6R-XV	B80		
TRC6-EU	B87	TV18-8F-XV	B80		
TRC6F	B88	TV18-8LFD-XV	B81		
TRC8	B87	TV18-8LF-XV	B81		
TV10-00QS-V	B81	TV18-8R-XV	B80		
TV10-10BL-XV	B80	TV18-BS-XV	B80		
TV10-10F-XV	B80	TVF10-250FDD-XV	B81		
TV10-10LFD-XV	B81	TVF10-250FD-XV	B81		
TV10-10LF-XV	B81	TVF14-250FDD-XV	B81		
TV10-10R-XV	B80	TVF14-250FD-XV	B81		
TV10-14F-XV	B80	TVF18-250FDD-XV	B81		
TV10-14PT-XV	B80	TVF18-250FD-XV	B81		
TV10-14R-XV	B80	VB-10BR	B86		
TV10-18-BS	B80	VB-10RR	B86		
TV10-250FDD-XV	B81	VB-10YF	B89		
TV10-250FD-XV	B80	VB-10YR	B86		
TV-10-250MDD-XV	B82	VB-35BF	B89		

Regional Sales Offices

Atlantic Provinces

Tel.: +1 (902) 450 1307
Toll Free: +1 (877) 862 4357
Fax: +1 (902) 450 1309

Quebec

Tel.: +1 (450) 466 1102
Toll Free: +1 (800) 465 1399
Fax: +1 (450) 466 1163

Ontario

Tel.: +1 (905) 635 7888
Toll Free: +1 (877) 291 7771
Fax: +1 (905) 635 7889

Manitoba / Saskatchewan

Tel.: +1 (604) 598 9811
Toll Free: +1 (866) 540 8220
Fax: +1 (604) 598 9840

Alberta

Tel.: +1 (780) 424 7092
Toll Free: +1 (888) 664 5666
Fax: +1 (780) 424 7093

British Columbia

Tel.: +1 (604) 598 9811
Toll Free: +1 (866) 540 8220
Fax: +1 (604) 598 9840

Additional information

We reserve the right to make technical changes or modify the contents of this document without prior notice. With regard to purchase orders, the agreed particulars shall prevail. ABB Inc. does not accept any responsibility whatsoever for potential errors or possible lack of information in this document.

We reserve all rights in this document and in the subject matter and illustrations contained therein. Any reproduction, disclosure to third parties or utilization of its contents – in whole or in parts – is forbidden without prior written consent of ABB Inc.



Canada

ABB Electrification Canada ULC

Installation Products

700 Thomas Avenue

Saint-Jean-sur-Richelieu, Quebec J2X 2M9

Tel.: +1 (450) 347 5318

Toll Free: +1 (800) 362 2952

Fax: +1 (450) 347 1976

tnb.ca.abb.com