



Catalog



MOVI-C® Software Modules



Table of contents

1	Introduction	6
1.1	The SEW-EURODRIVE group of companies	6
1.1.1	Global presence	6
1.1.2	Always the right drive solution.....	6
1.1.3	Your ideal partner.....	8
1.2	Documentation.....	9
1.2.1	Content of this documentation	9
1.2.2	Additional documentation	9
1.3	Product names and trademarks.....	9
1.4	Copyright notice.....	9
2	System description	10
2.1	MOVI-C® modular automation system	10
2.2	MOVI-C® software modules	11
2.2.1	Type code	12
3	Licensing	13
3.1	License model.....	13
3.1.1	Performance licenses.....	13
3.1.2	Single licenses	13
3.2	Purchasing software licenses	14
3.3	Checking a software license	14
3.3.1	About the MOVISUITE® License Manager	14
3.3.2	Using the web application of Online Support	15
3.3.3	Missing licenses	15
3.4	Activating a software license.....	16
3.4.1	With internet connection.....	16
3.4.2	Without internet connection.....	18
3.5	Reactivating a software license	19
3.6	Trial licenses	21
3.7	License overview	23
3.7.1	MOVISUITE®	23
3.7.2	MOVIRUN®.....	24
3.7.3	Automation Framework.....	24
3.7.4	Communication	24
3.7.5	Drive.....	24
3.7.6	Energy Recovery.....	26
3.7.7	Motion	26
3.7.8	MultiAxisController	26
3.7.9	MultiMotion.....	26
3.7.10	Power and Energy Solutions.....	27
3.7.11	Robotics	27
3.7.12	SingleAxis	28
3.7.13	StackerCrane	28
3.7.14	Visualization.....	28

4	MOVISUITE®	30
4.1	MOVISUITE® standard	30
4.2	MOVISUITE® apps	30
4.2.1	MOVISUITE® CamEditor	30
4.2.2	MOVISUITE® RobotMonitor	31
5	MOVIRUN®	32
5.1	MOVIRUN® flexible	32
6	MOVIKIT®	33
6.1	Category "Automation Framework"	34
6.1.1	MOVIKIT® Automation Framework	34
6.2	Category "Communication"	36
6.2.1	MOVIKIT® OPC UA	36
6.2.2	MOVIKIT® OPC UA add-on SensorInterface	38
6.3	Category "Drive"	40
6.3.1	MOVIKIT® BinaryTablePositioning Drive	40
6.3.2	MOVIKIT® Positioning Drive	41
6.3.3	MOVIKIT® RapidCreepPositioning Drive	42
6.3.4	MOVIKIT® Velocity Drive	43
6.4	Category "Energy Recovery"	44
6.4.1	MOVIKIT® EnergyRecovery	44
6.5	Category "Motion"	45
6.5.1	MOVIKIT® EncoderInterface	45
6.5.2	MOVIKIT® Motion add-on AntiSway	46
6.6	Category "MultiAxisController"	48
6.6.1	MOVIKIT® MultiAxisController	48
6.6.2	MOVIKIT® MultiAxisController Torque	50
6.6.3	MOVIKIT® MultiAxisController Skewing	51
6.6.4	MOVIKIT® MultiAxisController add-on FourAxes	52
6.6.5	MOVIKIT® MultiAxisController add-on Cascading	53
6.7	Category "MultiMotion"	54
6.7.1	MOVIKIT® MultiMotion	54
6.7.2	MOVIKIT® MultiMotion Gearing	55
6.7.3	MOVIKIT® MultiMotion Camming	56
6.7.4	MOVIKIT® MultiMotion Camming add-on AntiSlosh	57
6.7.5	MOVIKIT® MultiMotion Camming add-on Interpolation	58
6.7.6	MOVIKIT® MultiMotion Auxiliary Velocity	60
6.7.7	MOVIKIT® MultiMotion Auxiliary Positioning	61
6.7.8	MOVIKIT® MultiMotion add-on PositionController	62
6.7.9	MOVIKIT® MultiMotion add-on CombinedEncoderEvaluation	63
6.8	Category "Power and Energy Solutions"	64
6.8.1	MOVIKIT® Power and Energy Solutions DirectMode	64
6.8.2	MOVIKIT® Power and Energy Solutions EnergyMode	66
6.8.3	MOVIKIT® Power and Energy Solutions PowerMode	68
6.9	Category "Robotics"	70
6.9.1	MOVIKIT® Robotics	70

6.9.2	MOVIKIT® Robotics add-on MediumModels	72
6.9.3	MOVIKIT® Robotics add-on LargeModels	73
6.9.4	MOVIKIT® Robotics add-on Circle.....	74
6.9.5	MOVIKIT® Robotics add-on ConveyorTracking.....	75
6.10	Category "SingleAxis"	76
6.10.1	MOVIKIT® Gearing	76
6.10.2	MOVIKIT® Positioning	78
6.10.3	MOVIKIT® Velocity	79
6.10.4	MOVIKIT® Winder.....	80
6.10.5	MOVIKIT® RotaryKnife	81
6.10.6	MOVIKIT® FilmFeeder.....	82
6.11	Category "StackerCrane"	84
6.11.1	MOVIKIT® StackerCrane effiDRIVE®	84
6.11.2	MOVIKIT® StackerCrane MultiMotion.....	87
6.11.3	MOVIKIT® StackerCrane MultiAxisController	88
6.12	Category "Visualization"	89
6.12.1	MOVIKIT® Visualization basic	89
6.12.2	MOVIKIT® Visualization flexible.....	90
6.12.3	MOVIKIT® Visualization multi	91
6.12.4	MOVIKIT® Web Visualization	92
7	Example applications with licensing	93
7.1	Gantry crane (MOVIKIT® MultiAxisController)	93
7.2	Robot (MOVIKIT® Robotics)	94
7.3	Storage/retrieval system (MOVIKIT® StackerCrane effiDRIVE®)	95
7.3.1	Rigid, low pallet stacker crane	95
7.3.2	Rigid pallet stacker crane with shuttle (without telescope).....	96
7.3.3	High heavy-duty pallet warehouse or high lightweight box warehouse susceptible to vibration.....	97

1 Introduction

1.1 The SEW-EURODRIVE group of companies

1.1.1 Global presence

Driving the world – with innovative drive solutions for all industries and for every application. Products and systems from SEW-EURODRIVE are used all over the world. Be it in the automotive, building materials, food and beverage, or metal-processing industry – the decision to use drive technology "made by SEW-EURODRIVE" stands for reliable products with regard to functionality and investment.

Products and services from SEW-EURODRIVE are represented in all important industries of our time. We also show this presence with subsidiaries and production plants all over the world, as well as with our service, which we see as an integrative part of our portfolio that extends SEW-EURODRIVE's high quality standards.

1.1.2 Always the right drive solution

With the broad product range of SEW-EURODRIVE, which also includes mechatronic drive units, frequency inverters, controllers, software and communication in addition to the tried-and-tested modular system for gearmotors, it is possible to implement the perfect drive solution for every application.

Gear units and motors

Using the modular system, gearmotors can be individually assembled according to the required speed and torque ranges, the available space and the ambient conditions. Gear units and gearmotors offering a unique and finely tuned power range and the best economic prerequisites to face any drive challenge.

Motors by SEW-EURODRIVE can be mounted directly or via adapter to SEW-EURODRIVE gear units. They meet all global requirements in terms of energy efficiency and technical regulations. A wide range of options and accessories ensures high flexibility for adjusting the motor to the requirements of the user and the application.

Inverter

The proven inverter series MOVITRAC[®], MOVIDRIVE[®] and MOVIAXIS[®] enhance the gearmotors, forming a combination that blends in perfectly with the existing range of SEW-EURODRIVE systems.

Modular automation system

With its brand MOVI-C[®], SEW-EURODRIVE launches a new generation of drive and automation technology. MOVI-C[®] is the modular automation system that allows for the highest level of system and machine automation. It comprises drive technology, motion control, control technology and visualization.

MOVIDRIVE[®] modular is the modular application inverter for all types of applications, ranging from simple open-loop speed control to servo drives with kinematic model. MOVIDRIVE[®] modular can be supplemented by connecting MOVIDRIVE[®] system single-axis units. These possess functionalities comparable to those of axis modules, but have their own line connection. Especially in the upper power range, MOVIDRIVE[®] system complements the modular application inverter.

MOVIDRIVE® modular and MOVIDRIVE® system are intended for operation on the MOVI-C® CONTROLLER, the controller from SEW-EURODRIVE. They offer a powerful clock-synchronous connection via the integrated EtherCAT®/SBus^{PLUS} communication interface. Other EtherCAT® stations from SEW-EURODRIVE or other manufacturers can be controlled and diagnosed by the MOVI-C® CONTROLLER.

The MOVISUITE® engineering software with its unique operating philosophy is above all MOVI-C® hardware and software components. MOVISUITE® was developed with a focus on systematically shortening the startup time and covers the entire engineering process, from planning to diagnostics.

Decentralized drive technology

For economical, decentralized installations, SEW-EURODRIVE offers components from decentralized drive technology, such as MOVIMOT®, the gearmotor with integrated frequency inverter, or MOVI-SWITCH®, the gearmotor with integrated switching and protection function. SEW-EURODRIVE hybrid cables have been designed specifically to ensure cost-effective solutions, independent of the philosophy behind or the size of the system.

The decentralized drive technology portfolio is complemented by the DRC.. electronic motor, MOVIGEAR® mechatronic drive system, MOVIFIT® decentralized drive controller, MOVIPRO® decentralized drive, positioning, and application controller, as well as MOVITRANS® system components for contactless energy transfer.

The smart energy management system MOVI-DPS® enhances the modular product range of SEW-EURODRIVE. With MOVI-DPS®, SEW-EURODRIVE offers the perfect combination: Conserving resources. Reducing costs.

MOVI-DPS® allows for stable power grids, no power failures, and consequently reliable system availability. MOVI-DPS® is convincing in both mobile and stationary applications. In addition, MOVI-DPS® can be combined with other systems, such as the contactless energy transfer system MOVITRANS®, resulting in further important synergy effects.

Industrial gear units

Power, quality and sturdy design combined in one standard product: With high torque levels, industrial gear units from SEW-EURODRIVE realize major movements. The modular concept once again provides optimum adaptation of industrial gear units to meet a wide range of different applications.

Individual system solutions with MAXOLUTION®

MAXOLUTION® from SEW-EURODRIVE provides individual system solutions in all areas of system and machine automation. From electromechanical drives, controllers and communication to visualization and the contactless energy transfer system MOVITRANS® up to a comprehensive service portfolio, MAXOLUTION® offers all modules required to design customer-specific solutions for machines and systems.

MAXOLUTION® combines individual products of the proven modular system with innovative system components to form individual system solutions that perfectly match the requirements of the specific application – "powered by SEW-EURODRIVE".

Safe – flexible – effective: safetyDRIVE

Guaranteeing the safety of all employees and preventing work accidents while ensuring trouble-free production processes are demands placed on all production areas. safetyDRIVE, the comprehensive safety concept, allows you to implement your machines "safely," in accordance with the currently valid guidelines. With controllers that meet the respective requirement of the safety categories or performance levels and that monitor instead of shut down.

All of our drive and frequency inverters provide the function that safely stops the electrical power to the motor (STO). The MOVISAFE® components complete the product range – integrated into the inverter as DFS..B or DCS..B option cards or modular as UCS..B safety modules. The decentralized MOVIFIT® and MOVIPRO® drive controllers with integrated safety functions are ready for use in decentralized installations.

The functionally safe motor options allow for implementing safety functions in safety-related applications. Safety encoders are used to implement safety functions with respect to speed, direction of rotation, standstill, and relative position. Safety brakes can implement safety functions with respect to decelerating and stopping.

1.1.3 Your ideal partner

Its global presence, extensive product portfolio and broad spectrum of services make SEW-EURODRIVE the ideal partner for the machinery and plant construction industry when it comes to providing drive systems for demanding drive tasks in all industries and applications.

For detailed information on the entire product range of SEW-EURODRIVE, refer to our website www.sew-eurodrive.com. The website provides information about components, system solutions, services, and industries. Online Support provides access to a wide range of documents and tools such as the product configurator and various selection aids, as well as all documentation available for download in various languages.

1.2 Documentation

1.2.1 Content of this documentation

This document gives an overview of all the software modules available in the MOVI-C® modular automation system. A brief description of the function, as well as information on the required licenses and order information, is provided for each software module.

1.2.2 Additional documentation

For a more detailed description of the individual software modules, refer to the respective manuals. The manuals are available on the [website of SEW-EURODRIVE](#) under Online Support, and are linked in this document in the respective chapter.

1.3 Product names and trademarks

All product names included in this documentation are trademarks or registered trademarks of the respective titleholders.

1.4 Copyright notice

© 2021 SEW-EURODRIVE. All rights reserved. Unauthorized reproduction, modification, distribution or any other use of the whole or any part of this documentation is strictly prohibited.

2 System description

2.1 MOVI-C® modular automation system

With its brand MOVI-C®, SEW-EURODRIVE is launching a new generation of drive and automation technology. MOVI-C® is the modular automation system that allows for the highest level of system and machine automation.

MOVI-C® comprises drive technology, motion control, control technology, and visualization. The individual hardware and software modules are optimally coordinated with one another.

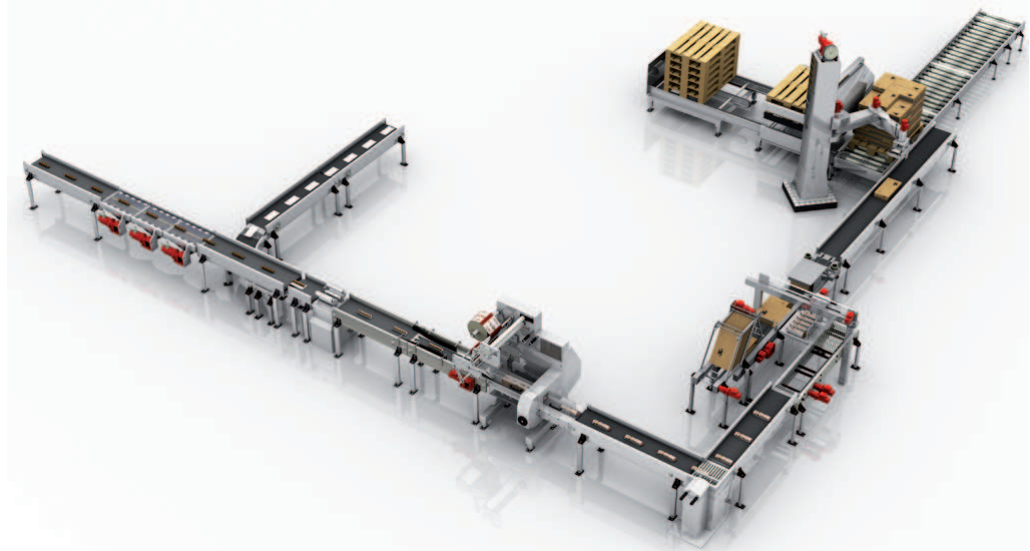

19041901451

The product portfolio comprises both purely parameterizable and freely programmable MOVI-C® CONTROLLERS. In both cases, the foundation for solving movement and drive tasks is the MOVIRUN® software platform and the MOVIKIT® software modules.

The MOVISUITE® engineering software, with its unique operating philosophy, prevails over all MOVI-C® hardware and software modules. MOVISUITE® was developed with a focus on systematically shortening the startup time and covers the entire engineering process, from planning to diagnostics.

Ideally adapted application inverters are available in the form of generation C MOVIDRIVE® devices. These inverters control SEW-EURODRIVE's entire range of asynchronous and synchronous motors, with and without encoder feedback, and in this way reduce variance and consequently warehousing costs to a minimum.

The MOVIDRIVE® application inverters are supplemented by the "Power and Energy Solutions" product series. Its intelligent power and energy management components as well as customized MOVIKIT® software modules allow for configuring integrated and highly communicative energy supply solutions.

The system is completed by fully integrated functional safety technology. This makes safe movement, safe braking, safe end positions and safe vertical drives available as standard.

Various I/O systems and visualizations are also available for automation solutions. Visualization can be implemented with monitors and web panels of various sizes.

Hardware and software in the MOVI-C® product portfolio

The entire clock-synchronous communication between the MOVI-C® CONTROLLER and all subordinate automation components is implemented using the EtherCAT®/SBus^{PLUS} system bus. Safe and non-safe process data, engineering and diagnostics data are transported via this bus. Third-party components that support EtherCAT® for importing the project planning file are also supported. A variety of options for addressing slave components enable simple data management in case of service incidents.

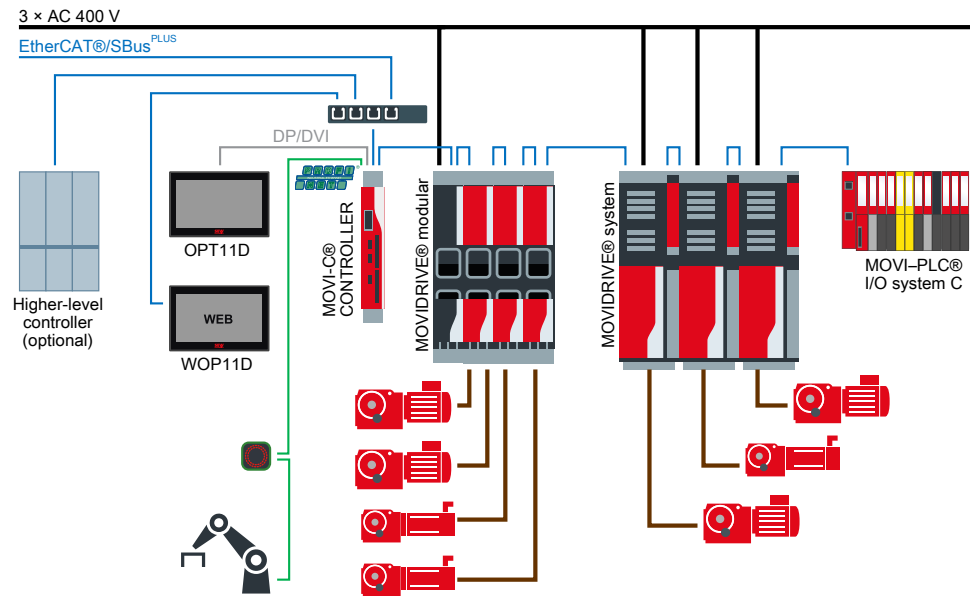

18014423783296523

2.2 MOVI-C® software modules

MOVI-C® software modules are divided into three areas:

- **MOVISUITE® engineering software**

One engineering software solution for all components from the MOVI-C® modular automation system. MOVISUITE® standard is free of charge. Various MOVISUITE® apps are available to expand the scope of functions.

- **MOVIRUN® software platform**

Software platform for MOVI-C® CONTROLLERS that determines the type of the runtime system. MOVIRUN® flexible allows for implementing simple or complex motion control functions, and for efficiently utilizing these functions by means of graphical user interfaces.

- **MOVIKIT® software modules**

Preconfigured software modules that can be taken into operation easily by means of configuration and diagnostics via graphical user interfaces. MOVIKIT® software modules are divided into different categories and are available for the various MOVIRUN® software platforms.

2.2.1 Type code

The following table shows the structure of the type code by way of an example:

SMR0001-040 (MOVIRUN® flexible for MOVI-C® CONTROLLERS of the advanced performance class)		
Type ID	S	• S = Software
Software group	MR	<ul style="list-style-type: none"> • DR = DriveRadar • MK = MOVIKIT® • MR = MOVIRUN® • MS = MOVISUITE® • SE = SoftwareServices
Software category	00	<ul style="list-style-type: none"> • 00 = Motion/MultiMotion • 10 = Drive • 11 = Robotics • 12 = MultiAxisController • 13 = StackerCrane • 14 = Power and Energy Solutions • 15 = Communication/Visualization • 16 = Mobile Systems • 17 = SingleAxis • 20 = Automation Framework • 21 = Energy Recovery
Software number	01	• 01 = MultiMotion Camming
Platform	020	<ul style="list-style-type: none"> • 020 = standard (UHX25A) • 040 = advanced (UHX45A) • 060 = progressive (UHX65A) • 080 = power (UHX85A)

3 Licensing

A license is required for using certain MOVI-C® software components. The following chapters provide detailed information on licensing and the license model.

3.1 License model

The license model for MOVI-C® software modules distinguishes between performance licenses and single licenses. Refer to the following chapters for information on the difference between these license types. For information on which type of license is required for which MOVI-C® software module, refer to the chapters of the corresponding software modules:

- "MOVISUITE®" (→ 30)
- "MOVIRUN®" (→ 32)
- "MOVIKIT®" (→ 33)

3.1.1 Performance licenses

Performance licenses for a software function have to be purchased only once per MOVI-C® CONTROLLER. With this license type, the function can be used for any number of instances. The price for performance licenses is tiered depending on the performance class of the MOVI-C® CONTROLLER in use.

If the function is a software function for axes, then the number of axes that can be used is limited by the recommended maximum number of axes of the respective MOVI-C® CONTROLLER.

Recommended maximum number of axes:

MOVI-C® CONTROLLER	Recommended maximum number of axes
standard UHX25A	2 interpolated – 6 auxiliary axes
advanced UHX45A	8 interpolated – 8 auxiliary axes
progressive UHX65A	16 interpolated – 16 auxiliary axes
power UHX85A	32 interpolated – 32 auxiliary axes

Examples of performance licenses:

MOVIRUN® flexible, MOVIKIT® MultiMotion Camming

The performance license for using cam axes or synchronous operation axes is purchased once per MOVI-C® CONTROLLER and allows for using the software component for as many axes as are possible with the MOVI-C® CONTROLLER in use.

3.1.2 Single licenses

Single licenses must be purchased individually for each instance that wants to use the respective software component. There is a fixed price for single licenses irrespective of the performance class of the MOVI-C® CONTROLLER in use.

Examples of single licenses:

MOVIKIT® Robotics, MOVIKIT® MultiAxisController, MOVIKIT® StackerCrane

If 2 robots are implemented, the single license MOVIKIT® Robotics (SMK1101-000) is required twice.

3.2 Purchasing software licenses

Licenses for MOVI-C® software components can be obtained via the conventional sales channel or via Online Support. Licenses can be obtained in the following ways:

Together with the controller hardware

If you purchase the software license together with the hardware component, the licenses will be activated directly on the memory card of the MOVI-C® CONTROLLER at the factory. You will receive a complete, operational system.

Together with a storage medium

If you purchase the software license together with a storage medium, the licenses will be activated directly on the memory card of the MOVI-C® CONTROLLER at the factory. You will receive a pre-installed memory card ready for use.

Individually

Licenses can be purchased at any time via Online Support or by calling the SEW Service Hotline. You will receive a license key and an activation key for the software license you have purchased. With these keys you can activate the software function on hardware using the MOVISUITE® License Manager.

3.3 Checking a software license

You can check the type of licenses available on a memory card in several ways:

3.3.1 About the MOVISUITE® License Manager

Establish a connection with the MOVI-C® CONTROLLER and open the License Manager via the context menu of the MOVI-C® CONTROLLER in MOVISUITE®. The License Manager checks which licenses are available on the memory card and displays the result.

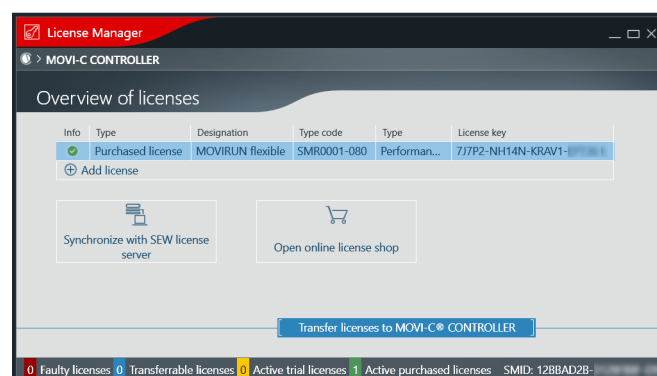

3.3.2 Using the web application of Online Support

Navigate to Online Support on the SEW-EURODRIVE website. This is where you find the web application "Check and activate software licenses". Enter the SMID (SEW-EURODRIVE Memory ID) printed on your memory card in the edit box. A list opens with all licenses assigned to this memory card.

3

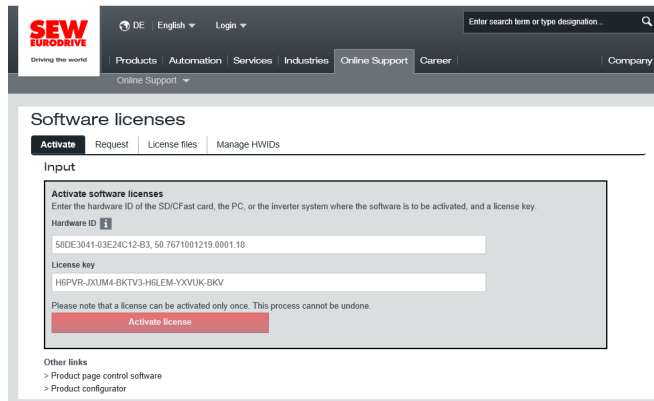

3.3.3 Missing licenses

When starting the IEC program, MOVIKIT® software modules that require a license check whether the required license is available. If no license is present, the software module reports an error and a symbol is displayed in the "Info" column in the MOVISUITE® License Manager to indicate that the license is missing. This error cannot be acknowledged.

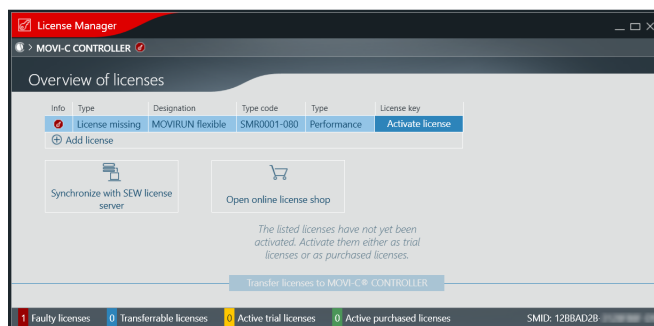

26876124/EN – 08/2021

3.4 Activating a software license

When purchasing a "single" (→ 14) software license for a software component, the buyer receives a license key.

Example of a license key: 77322-TR75W-TQ6WR-S9P8V-WKLVV-94A

This license key is not linked to a specific hardware component (of a memory card). The license key is linked to a hardware component by activating the license. After activating the license, the licensed software component can only be executed on the linked hardware component. The license on the memory card is only valid and available following a successful activation.

When activating a license, an activation key is generated from the license key and the memory card ID SMID (SEW-EURODRIVE memory ID), and is transferred to the memory card with a license file.

Example of an activation key: X6J84L4F

A license is activated using the MOVISUITE® License Manager. If there is an internet connection from the engineering PC, all you have to do is enter the license key. If there is no internet connection from the engineering PC, you will have to enter the license key and the associated activation key.

A connection with an SEW-EURODRIVE license server is required to generate the activation key. The license server generates the activation key and registers the license key and the SMID.

3.4.1 With internet connection

Do the following to activate the license:

- ✓ Connection between MOVISUITE® and MOVI-C® CONTROLLER.
 - ✓ PC or notebook with internet connection is available.
 - ✓ One or several licenses were purchased and you have received the associated license keys.
1. Establish a connection between your PC or notebook and the MOVI-C® CONTROLLER.
 2. In MOVISUITE®, open the License Manager via the context menu of the MOVI-C® CONTROLLER.
 3. In the list in the License Manager, click the [Activate license] button for the license you wish to activate.

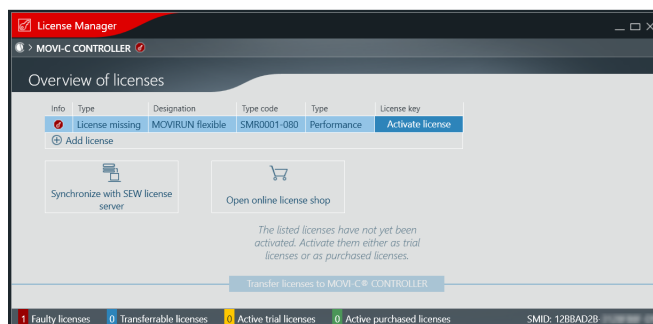

⇒ The "Activate license" window is displayed.

4. In the "Activate license" window, select the option "Activate license via Internet".

5. Enter the respective license key. If you have purchased single licenses, you can also enter several license keys. The SMID of your memory card is read automatically and is displayed.

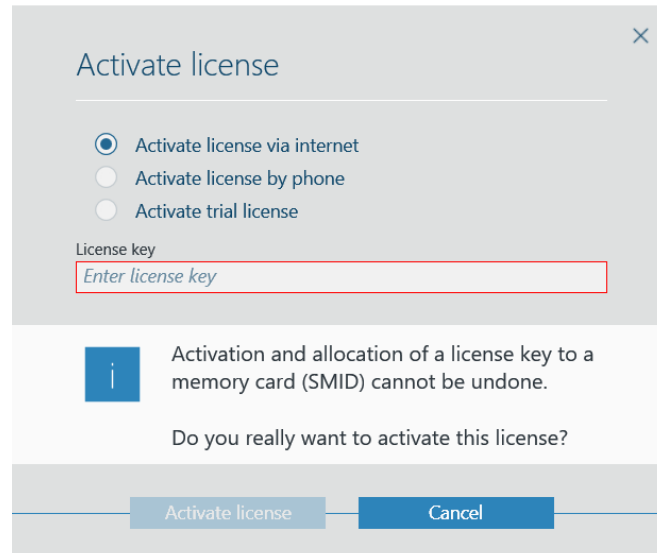

6. To perform the activation, click the [Activate license] button.
 - ⇒ MOVISUITE® establishes a connection with the SEW license server and registers the license.
 - ⇒ The license is now linked with the memory card. The entered license key is used up and cannot be used for any other memory card.
7. To activate further licenses, repeat the previous steps.
8. To complete activation and to transfer the licenses to the memory card, click the [Transfer licenses to MOVI-C® CONTROLLER] button.
9. Restart the MOVI-C® CONTROLLER for the changes to take effect.
10. After having restarted the MOVI-C® CONTROLLER, open the License Manager again and check whether further licenses are displayed.

3.4.2 Without internet connection

Do the following to activate the license:

- ✓ Connection between MOVISUITE® and MOVI-C® CONTROLLER.
 - ✓ One or several licenses were purchased and you have received the associated license keys and activation keys. For more information, refer to chapter "Requesting an activation key" (→ 19).
1. Establish a connection between your PC or notebook and the MOVI-C® CONTROLLER.
 2. In MOVISUITE®, open the License Manager via the context menu of the MOVI-C® CONTROLLER.
 3. In the list in the License Manager, click the [Activate license] button for the license you wish to activate.
 4. In the "Activate license" window, select the option "Activate license by phone".
 5. Enter the respective license key and the associated activation key requested by phone. (The SMID of your memory card is read automatically and is displayed.)

6. To perform the activation, click the [Activate license] button.
 - ⇒ MOVISUITE® checks the data you have entered and displays a corresponding message.
7. To activate further licenses, repeat the previous steps.
8. To complete activation and to transfer the licenses to the memory card, click the [Transfer licenses to MOVI-C® CONTROLLER] button.
9. Restart the MOVI-C® CONTROLLER for the changes to take effect.
10. After having restarted the MOVI-C® CONTROLLER, open the License Manager again and check whether further licenses are displayed.

Requesting an activation key

Via SEW hotline

- ✓ You know the SMID of the memory card of your MOVI-C® CONTROLLER. You find the SMID printed on the memory card or in the License Manager in MOVISUITE®.
 - ✓ You know which license you need or you know the license key of the license you have purchased. To view missing licenses, open the License Manager in MOVISUITE®.
1. Call the SEW hotline and request a license activation for MOVI-C® CONTROLLER.
 - ⇒ The service employee on the phone will ask for your customer data, the SMID of your memory card, and which license you wish to purchase. If you have already purchased a license, you can quote the license key instead.
 2. Provide the service employee with the necessary information.
 - ⇒ If you do not yet have a license, the service employee will obtain the required license and generates the activation key from the license key and the SMID you have provided. If you have specified a license key, the service employee will generate the activation key from the specified SMID and this license key.
 - ⇒ The service employee informs you about the activation key and, if you have purchased a new license, also about the license key. The entered license key is used up and cannot be used for any other memory card.
- ⇒ You can use the activation key together with the SMID for activating the license on your memory card.

Via Online Support

- ✓ You know the SMID of the memory card of your MOVI-C® CONTROLLER. You find the SMID printed on the memory card or in the License Manager in MOVISUITE®.
 - ✓ You know the license key of the license you have purchased.
1. Open the SEW website and navigate to Online Support and select "Startup & maintenance".
 2. Click the link to the web application "Check and activate software licenses".
 3. Enter the SMID of the memory card where you want to activate the license and the license key of the purchased license in the respective fields.
 4. Click the [Send request] button.
 - ⇒ You will obtain the activation key. The entered license key is used up and cannot be used for any other memory card.
 - ⇒ You can use the activation key together with the matching license key for activating the license on your memory card.

3.5 Reactivating a software license

An already activated license that is lost for any reason (e.g. by manually deleting the license files from the memory card) can be reactivated.

Do the following to reactivate a license:

- ✓ There is a connection between MOVISUITE® and the MOVI-C® CONTROLLER.
- ✓ A PC or notebook with Internet connection is available.

3

Licensing

Reactivating a software license

- ✓ One or several licenses were purchased and you have received the associated license keys.
 - ✓ The license has already been activated for the memory card of the MOVI-C® CONTROLLER used.
 - ✓ The license is nevertheless reported as missing.
1. Establish a connection between your PC or notebook and the MOVI-C® CONTROLLER.
 2. Open the License Manager in MOVISUITE® via the context menu of the MOVI-C® CONTROLLER or via the error message.

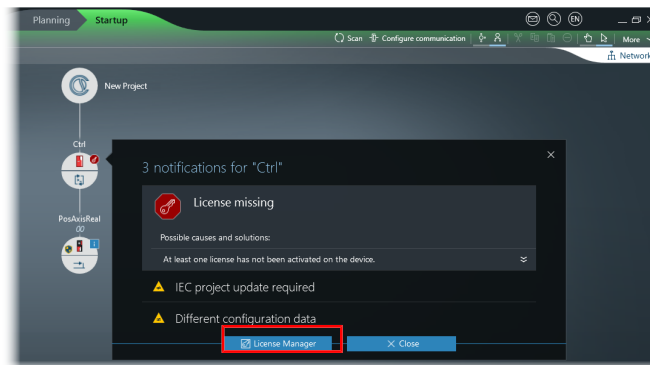

3. In the License Manager, click the [Synchronize with license server of SEW-EURODRIVE] button.

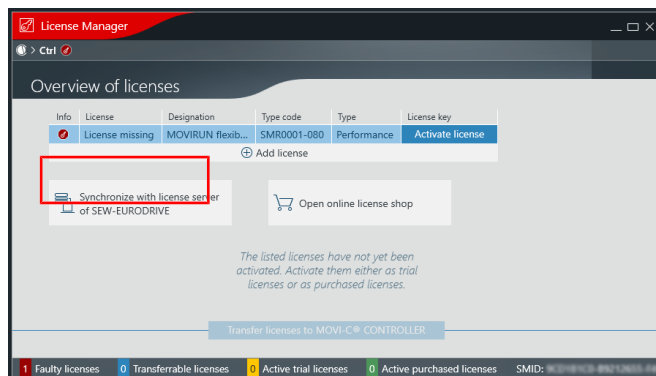

- ⇒ All licenses already activated on this memory card are loaded again by the License Manager of SEW-EURODRIVE and are available for transfer to the MOVI-C® CONTROLLER.

4. In the License Manager, click the [Transfer licenses to MOVI-C® CONTROLLER] button.

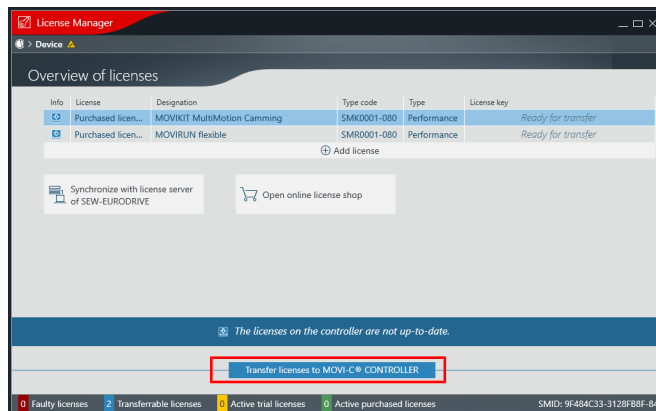

⇒ The status of the licenses in the License Manager is now up-to-date again.

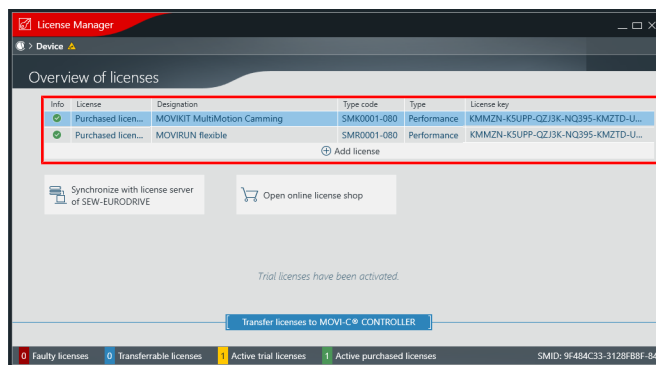

3.6 Trial licenses

SEW-EURODRIVE offers trial licenses to test the functions of MOVI-C® software modules. The trial licenses are valid for 7 days and offer the entire scope of functions during this trial period. After expiration of the trial period, you will have to purchase a license to be able to continue to use the software module. Expiry of the trial license is logged and is displayed by a notification symbol in MOVISUITE® at the node of the MOVI-C® CONTROLLER.

Activating the trial license

When starting the MOVI-C® CONTROLLER, the system checks whether the licenses required for the MOVI-C® software modules in use have been activated on the memory card. If a license is not available, MOVISUITE® is notified and you can activate a 7-day trial license.

Do the following to activate the trial license:

1. Open the License Manager via the context menu of the MOVI-C® CONTROLLER in MOVISUITE®.
 - ⇒ The License Manager provides an overview of licenses that are already active on the memory card of the MOVI-C® CONTROLLER and of licenses that are additionally required. Missing licenses are marked by a red icon.

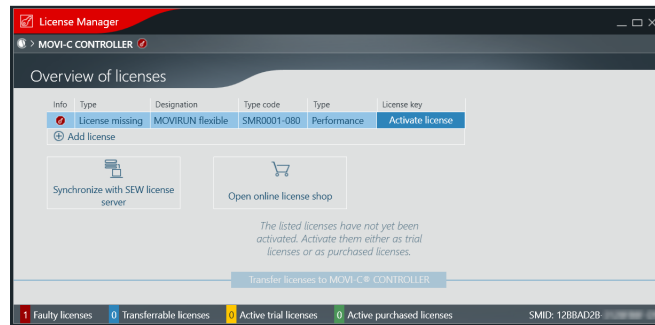

2. In the list in the License Manager, click the [Activate license] button for the trial license you wish to activate.
3. In the "Activate license" window, select the option "Activate trial license" and click the [Activate license] button.

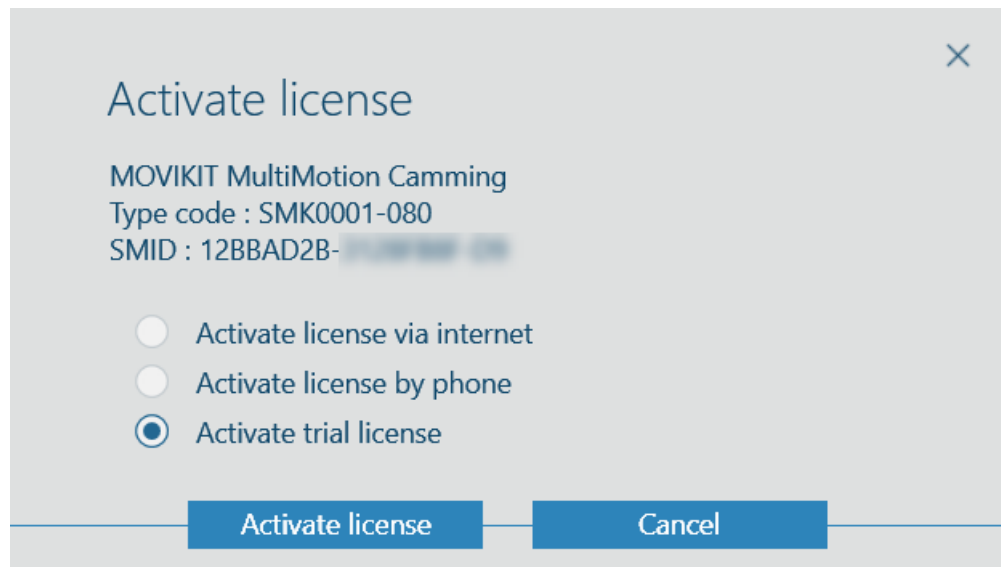

- ⇒ MOVISUITE® establishes a connection with the SEW license server and registers the license.

- To complete activation and to transfer the licenses to the memory card, click the [Transfer licenses to MOVI-C® CONTROLLER] button.



- Restart the MOVI-C® CONTROLLER for the changes to take effect.
 - ⇒ The 7-day trial license is now active. The license is marked by a yellow icon in the overview. The field "Days left before trial license expires" shows the remaining trial period. The trial period applies globally to all licenses and starts as soon as a trial license is activated. After expiry of the trial period, the respective software modules will issue a warning and MOVISUITE® reports that the trial period is over. It is now at the latest that you have to purchase and activate a license in order to continue to use the respective software functions. Expired trial licenses can be activated again for further trial.

3.7 License overview

The required performance class depends on the type of MOVI-C® CONTROLLER on which the software module is used:

MOVI-C® CONTROLLER	Required performance class
UHX25A	20
UHX45A	40
UHX65A	60
UHX85A	80

3.7.1 MOVISUITE®

Software license	Performance class	Type code
MOVISUITE® standard (→ 30)	Free software	

Software license	Performance class	Type code
MOVISUITE® CamEditor (→ 30)		Included in MOVISUITE® standard
MOVISUITE® RobotMonitor (→ 31)		Included in MOVISUITE® standard

3.7.2 MOVIRUN®

Software license	Performance class	Type code
MOVIRUN® flexible (→ 32)	020	SMR0001-020
	040	SMR0001-040
	060	SMR0001-060
	080	SMR0001-080

3.7.3 Automation Framework



Software license	Performance class	Type code
MOVIKIT® Automation Framework (→ 34)	020	SMR2001-020
	040	SMR2001-040
	060	SMR2001-060
	080	SMR2001-080

3.7.4 Communication

Software license	Performance class	Type code
MOVIKIT® OPC UA (→ 36)	020	SMK1501-020
	040	SMK1501-040
	060	SMK1501-060
MOVIKIT® OPC UA add-on SensorInterface (→ 38)	-	SMK1505-000

3.7.5 Drive

Software license	Performance class	Type code
MOVIKIT® BinaryTablePositioning Drive (→ 40)	-	SMK1010-000
MOVIKIT® Positioning Drive (→ 41)	-	SMK1002-000

Software license	Performance class	Type code
MOVIKIT® RapidCreepPositioning Drive (→  42)	-	SMK1007-000
MOVIKIT® Velocity Drive (→  43)	-	SMK1001-000

3.7.6 Energy Recovery

Software license	Performance class	Type code
MOVIKIT® Energy Recovery (→ 44)	-	SMK2101-000

3.7.7 Motion

Software license	Performance class	Type code
MOVIKIT® EncoderInterface (→ 45)	Included in MOVIRUN® flexible	
MOVIKIT® Motion add-on AntiSway (→ 46)	-	SMK0008-000

3.7.8 MultiAxisController

Software license	Performance class	Type code
MOVIKIT® MultiAxisController (→ 48)	-	SMK1201-000
MOVIKIT® MultiAxisController add-on Cascading (→ 53)	-	SMK1205-000
MOVIKIT® MultiAxisController add-on FourAxes (→ 52)	-	SMK1204-000
MOVIKIT® MultiAxisController Skewing (→ 51)	-	SMK1202-000
MOVIKIT® MultiAxisController Torque (→ 50)	-	SMK1201-000
MOVIKIT® MultiAxisController Torque and Skewing	-	SMK1203-000

3.7.9 MultiMotion

Software license	Performance class	Type code
MOVIKIT® MultiMotion (→ 54)	Included in MOVIRUN® flexible	
MOVIKIT® MultiMotion add-on CombinedEncoderEvaluation (→ 63)	020	SMK0007-020
	040	SMK0007-040
	060	SMK0007-060
	080	SMK0007-080
MOVIKIT® MultiMotion add-on PositionController (→ 62)	020	SMK0006-020
	040	SMK0006-040
	060	SMK0006-060
	080	SMK0006-080
MOVIKIT® MultiMotion Auxiliary Positioning (→ 61)	Included in MOVIRUN® flexible	

Software license	Performance class	Type code
MOVIKIT® MultiMotion Auxiliary Velocity (→ 60)	Included in MOVIRUN® flexible	
MOVIKIT® MultiMotion Camming (→ 56)	020	SMK0001-020
	040	SMK0001-040
	060	SMK0001-060
	080	SMK0001-080
MOVIKIT® MultiMotion Camming add-on AntiSlosh (→ 57)	020	SMK0013-020
	040	SMK0013-040
	060	SMK0013-060
	080	SMK0013-080
MOVIKIT® MultiMotion Camming add-on Interpolation (→ 58)	020	SMK0012-020
	040	SMK0012-040
	060	SMK0012-060
	080	SMK0012-080
MOVIKIT® MultiMotion Gearing (→ 55)	020	SMK0011-020
	040	SMK0011-040
	060	SMK0011-060
	080	SMK0011-080

3.7.10 Power and Energy Solutions

Software license	Performance class	Type code
MOVIKIT® Power and Energy Solutions DirectMode (→ 64)	Included in MOVIRUN® flexible	
MOVIKIT® Power and Energy Solutions EnergyMode (→ 66)	020	SMK1403-020
	040	SMK1403-040
	060	SMK1403-060
	080	SMK1403-080
MOVIKIT® Power and Energy Solutions PowerMode (→ 68)	020	SMK1402-020
	040	SMK1402-040
	060	SMK1402-060
	080	SMK1402-080

3.7.11 Robotics

Software license	Performance class	Type code
MOVIKIT® Robotics (→ 70)	-	SMK1101-000

26876124/EN – 08/2021

Software license	Performance class	Type code
MOVIKIT® Robotics add-on Circle (→ 74)	-	SMK1105-000
MOVIKIT® Robotics add-on ConveyorTracking (→ 75)	-	SMK1110-000
MOVIKIT® Robotics add-on LargeModels (→ 73)	-	SMK1102-000
MOVIKIT® Robotics add-on MediumModels (→ 72)	-	SMK1102-000
MOVIKIT® Robotics add-on Touchprobe	-	SMK1107-000

3.7.12 SingleAxis

Software license	Performance class	Type code
MOVIKIT® FilmFeeder (→ 82)	-	SMK1720-000
MOVIKIT® Gearing (→ 76)	020	SMK1709-020
	040	SMK1709-040
	060	SMK1709-060
	080	SMK1709-080
MOVIKIT® Positioning (→ 78)	Included in MOVIRUN® flexible	
MOVIKIT® RotaryKnife (→ 81)	-	SMK1740-000
MOVIKIT® Velocity (→ 79)	Included in MOVIRUN® flexible	
MOVIKIT® Winder (→ 80)	20	SMK1710-020
	40	SMK1710-040
	60	SMK1710-060
	80	SMK1710-080

3.7.13 StackerCrane

Software license	Performance class	Type code
MOVIKIT® StackerCrane effiDRIVE® (→ 84)	-	SMK1301-000
MOVIKIT® StackerCrane MultiAxisController (→ 88)	-	SMK1304
MOVIKIT® StackerCrane MultiMotion (→ 87)	-	SMK1303

3.7.14 Visualization

Software license	Performance class	Type code
MOVIKIT® Visualization basic (→ 89)	-	SSE0001-000

Software license	Performance class	Type code
MOVIKIT® Visualization flexible (→ 90)	-	SSE0002-000
MOVIKIT® Visualization multi (→ 91)	-	SSE0003-000
MOVIKIT® WebVisualization	20	SMK1504-020
	40	SMK1504-040
	60	SMK1504-060

4 MOVISUITE®

MOVISUITE® is the engineering software and operating platform for all MOVI-C® hardware and software modules.

4.1 MOVISUITE® standard



Functional description

The MOVISUITE® standard engineering software enables configuration, parameterization, and startup of the application via an intuitive user interface.

Overview of functions:

- Project management and project planning
- Startup of hardware and software modules
- Parameterization and programming of MOVIKIT® software modules
- Diagnostics of hardware and software modules
- Central data storage

The software is available free of charge via → [Online Support](#).

Project planning notes	
License type	No license required
Requirements	These are documented in the system requirements of each MOVISUITE® version

4.2 MOVISUITE® apps

MOVISUITE® apps expand the range of functions of MOVISUITE® standard by additional functions and features.

4.2.1 MOVISUITE® CamEditor



Functional description

The MOVISUITE® CamEditor is an intuitive tool for creating curve function descriptions for the MOVIKIT® MultiMotion Camming software module. Integration in MOVISUITE® allows for taking into account configuration data, such as user units and limits, when creating curve function descriptions.

Overview of functions:

- Creating curve function descriptions according to VDI 2143
- Creating curve function descriptions in user units
- Display of position, speed, acceleration, and jerk profiles
- Displaying set axis limits
- Automated conversion into time-based values

Project planning notes	
License type	Included as a convenient function in MOVISUITE® standard
Requirements	Windows 7 or later

Project planning notes	
Additionally required licenses	MOVISUITE® standard

4.2.2 MOVISUITE® RobotMonitor



The MOVISUITE® RobotMonitor is used to control and parameterize the MOVIKIT® Robotics software module and its add-ons.

Overview of functions:

- Control and diagnostics of the MOVIKIT® Robotics software module and its add-ons
- Robot control in manual mode and automatic mode
- Robot control in jog mode (by axis and Cartesian)
- Creating the sequential and motion programs in SEW Robot Language (SRL) by means of an editor among others with teach-in function for positions
- 3D visualization of the configured robot

The MOVISUITE® RobotMonitor is available for the engineering PC as well as a version for the mobile operator panel from SEW-EURODRIVE. The RobotMonitor can be operated on the stand-alone mobile operator panel or in combination with SEW visualization.

For more information, refer to the associated → [manual](#).

The software is available free of charge via → [Online Support](#).

Project planning notes	
License type	Included as a convenient function in MOVISUITE® standard
Requirements	Windows 7 or later
Additionally required licenses	MOVISUITE® standard

5 MOVIRUN®

MOVIRUN® is the software platform for MOVI-C® CONTROLLER. The type of MOVIRUN® defines whether a MOVI-C® CONTROLLER can be programmed freely or whether it requires parameterization.

5.1 MOVIRUN® flexible



Functional description

MOVIRUN® flexible is the open motion control and automation platform for MOVI-C® CONTROLLERS. This software platform makes the MOVI-C® CONTROLLER freely programmable by means of a modern programming system according to IEC 61131. MOVIRUN® flexible provides standard PLC functions as well as a high-performance real-time system.

Overview of functions:

- Automation with MOVI-C® and third-party components
- EtherCAT® fieldbuses are supported
- Provision of a modern programming system according to IEC 61131
- Using MOVIKIT® software modules in the programming environment
- Graphical configuration and diagnostics of MOVIKIT® software modules
- Provision of backup and restore functions in case of device replacement

Project planning notes	
License type	Performance license
Hardware requirements	MOVI-C® CONTROLLER (all performance classes)
Type code, part number	<ul style="list-style-type: none"> • SMR0001-020, 23371358 • SMR0001-040, 23371366 • SMR0001-060, 23371676 • SMR0001-080, 23371307

6 MOVIKIT®

MOVIKIT® software modules are preconfigured software modules for implementing simple drive functions, such as speed control and positioning, up to complex motion control functions, such as camming and robot control. The software modules are operated on various hardware, such as the real-time operating system of the MOVI-C® CONTROLLER, the MOVIDRIVE® application inverter or Windows devices. The software modules are divided into the following categories:

Category "Automation Framework" (→ 34)

The category "Automation Framework" includes a state and mode manager as well as various machine modules.

Category "Communication" (→ 36)

The category "Communication" includes MOVIKIT® software modules that provide various communication services.

Category "Drive" (→ 40)

The category "Drive" includes MOVIKIT® software modules that are operated directly on the MOVIDRIVE® application inverter.

The category "EnergyRecovery" includes MOVIKIT® software modules that can be used to implement energy supply solutions with the new block or sinusoidal energy recovery module MDR9.B-...

Category "Motion" (→ 45)

The category "Motion" includes MOVIKIT® software modules that provide specific motion control functions. The category also includes add-ons that can also be used for software modules of other categories, e.g. MOVIKIT® Motion add-on AntiSway.

Category "MultiAxisController" (→ 48)

The category "MultiAxisController" includes MOVIKIT® software modules for centrally controlling any number of mechanically coupled drives.

Category "MultiMotion" (→ 54)

The category "MultiMotion" includes MOVIKIT® software modules for implementing universal motion control functions for interpolating axes. A defined IEC interface can be used to activate and, for example, overlay motion profiles.

Category "Power and Energy Solutions" (→ 64)

The category "Power and Energy Solutions" includes energy supply solutions for inverters of the MOVIDRIVE® modular series.

Category "Robotics" (→ 70)

The category "Robotics" includes MOVIKIT® software modules for controlling robots.

Category "SingleAxis" (→ 76)

The category "SingleAxis" includes all MOVIKIT® software modules with parameterizable functions and with a standardized process data interface. Unlike the category "MultiMotion", no programming knowledge is required here for startup and diagnostics.

Category "StackerCrane" (→ 84)

The category "StackerCrane" includes MOVIKIT® software modules for implementing storage/retrieval systems.

Category "Visualization" (→ 89)

The category "Visualization" comprises MOVIKIT® software modules that support the graphic display of data of the MOVI-C® CONTROLLER.

6.1 Category "Automation Framework"

The category "Automation Framework" includes a state and mode manager as well as various machine modules.

6.1.1 MOVIKIT® Automation Framework**Functional description**

The MOVIKIT® Automation Framework software module provides a standardized state and mode manager. The automation framework is Pack-ML compatible, provides the defined interfaces, such as pack tags, and uses the defined modes and states. The basic program contains a master and an exemplary slave. More machine modules can be easily added to the program from a basic project. The MOVIKIT® Automation Framework software module additionally includes a number of functions, such as fault elimination and recipe handling, as well as a simulation environment for all incoming machine modules and prepared HMI modules.

Overview of machine modules:

- Conveyor linear
- Conveyor modulo
- Positioning linear
- Positioning modulo
- Rotary knife
- Pocket belt
- Smart belt
- Flying saw camming
- Flying saw gearing relative positioning
- Robotics XYZ
- Robotics XYZA
- Robotics XYZ tracking
- Robotics XYZA tracking
- MultiMotion_Gantry_XYZ
- MultiMotion_Tripod_XYZ
- Winder
- Roller
- Erector

The following figure illustrates the State and Mode Manager:

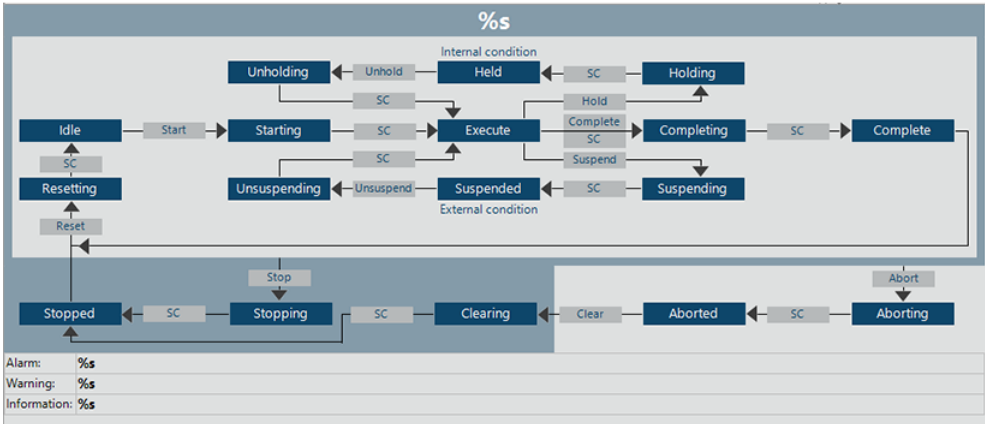

Project planning notes	
License type	Performance license
Hardware requirements	MOVI-C® CONTROLLER (all performance classes)
Additionally required licenses	<ul style="list-style-type: none"> • MOVIRUN® flexible • Further MOVIKIT® software modules might be necessary depending on the machine module
Type code, part number	SMK2001-020, 23373083 SMK2001-040, 23373091 SMK2001-060, 23373105 SMK2001-080, 23373113

6.2 Category "Communication"

The category "Communication" includes MOVIKIT® software modules that provide various communication services.

6.2.1 MOVIKIT® OPC UA



Functional description

The MOVIKIT® OPC UA software module provides a basic solution for integrating and visualizing components. The function is implemented using the OPC UA communication protocol. The MOVIKIT® OPC UA software module provides an OPC UA server on the MOVI-C® CONTROLLER. The server can be used for integrating field units, visualizations (such as HMI, tablets, augmented reality, etc.) or generally for transferring data.

The requirement for integrating third-party devices is that the OPC UA communication protocol is supported and an OPC UA client is provided. For more information, refer to the associated → [manual](#).

OPC UA topology

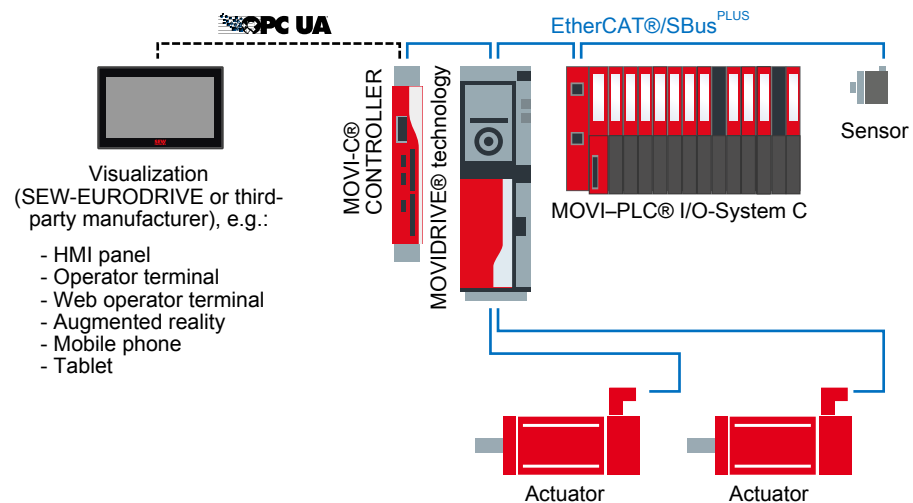

Project planning notes	
License type	Performance license
Hardware requirements	The software module is compatible with the following hardware: <ul style="list-style-type: none"> • MOVI-C® CONTROLLER standard UHX25A • MOVI-C® CONTROLLER advanced UHX45A • MOVI-C® CONTROLLER progressive UHX65A
Additionally required licenses	MOVIRUN® flexible

Project planning notes	
Type code	<ul style="list-style-type: none">• SMK1501-020, 23373008• SMK1501-040, 23373016• SMK1501-060, 23372540

6.2.2 MOVIKIT® OPC UA add-on SensorInterface



Functional description

The MOVIKIT® OPC UA add-on SensorInterface software module offers easy connection of various sensors via OPC UA client. The various sensor connections are combined under the MOVIKIT® OPC UA add-on SensorInterface license. The IoT sensor DUV40A from SEW-EURODRIVE (part number 19175892) is recommended.

The MOVIKIT® OPC UA add-on SensorInterface software module is an add-on product based on the MOVIKIT® OPC UA software module. This is the reason why both software modules are required. For more information, refer to the associated → manual.

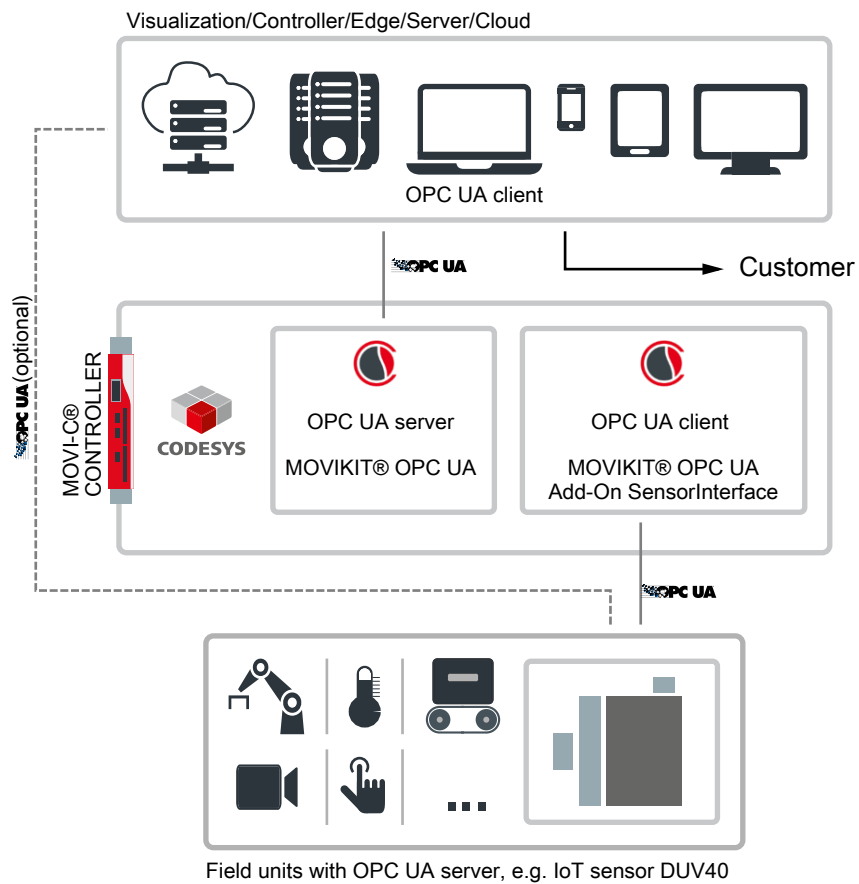

Project planning notes	
License type	Single license A separate license instance is required for each sensor used.
Hardware requirements	The software module is compatible with the following hardware: <ul style="list-style-type: none"> • MOVI-C® CONTROLLER standard UHX25A • MOVI-C® CONTROLLER advanced UHX45A • MOVI-C® CONTROLLER progressive UHX65A

Project planning notes	
Additionally required licenses	<ul style="list-style-type: none">• MOVIRUN® flexible• MOVIKIT® OPC UA
Type code, part number	SMK1505-000, 23373377

6.3 Category "Drive"

The category "Drive" includes MOVIKIT® software modules that are operated directly on the MOVIDRIVE® application inverter.

6.3.1 MOVIKIT® BinaryTablePositioning Drive



Functional description

The MOVIKIT® BinaryTablePositioning Drive software module allows for implementing positioning and speed applications and can be used with binary or AS-Interface controlled devices with identical scope of functions.

The software module mainly uses the basic functions of the application inverter in use by activating the respective function blocks (such as FCB09 "Position control", FCB05 "Speed control") depending on the application. This means the scope of functions depends on the application inverter in use (present motor encoder).

Overview of functions:

- Startup using a graphical user interface
- Dedicated parameter tree with all the parameters that are required for operation
- Provision of the following operating modes:
 - Table positioning (absolute, relative, modulo)
 - Teach mode for table positions
 - Referencing mode
 - Jog mode
 - Sensor-based positioning
 - Table speed control
- Diagnostic monitor for monitoring and controlling the axis
- Standardized interface assignment

For more information, refer to the associated manual.

Project planning notes	
License type	Single license
Required application level	Application level 1
Hardware requirements	The software module is compatible with the following hardware: <ul style="list-style-type: none"> • MOVIDRIVE® technology + CIO/CID • MOVI-C® decentralized electronics DAC (AS-Interface devices)
Type code, part number	SMK1010, 23373121

6.3.2 MOVIKIT® Positioning Drive



Functional description

The MOVIKIT® Positioning Drive software module allows for implementing positioning applications with a predefined fieldbus interface. The software module mainly uses the basic functions of the application inverter in use by activating the respective function blocks depending on the application. This means the scope of functions depends on the application inverter (e.g. with or without encoder feedback).

Overview of functions:

- Startup using a graphical user interface
- Dedicated parameter tree with all the parameters that are required for operation
- Provision of the following operating modes:
 - Jog mode
 - Velocity control
 - Positioning mode (relative, absolute, modulo)
 - Referencing mode
- Additional functions: variable jerk time, sensor-based positioning, parameter channel via process data
- Diagnostic monitor for monitoring and controlling the axis
- Standardized process data interface

For more information, refer to the associated → [manual](#).

Project planning notes	
License type	Single license
Required application level	Application level 1
Hardware requirements	The software module is compatible with the following hardware: <ul style="list-style-type: none"> • MOVIDRIVE® technology • MOVIGEAR® performance • MOVIMOT® performance • MOVIMOT® advanced • MOVIMOT® flexible • MOVITRAC® advanced
Type code, part number	SMK1002-000, 23371463

6.3.3 MOVIKIT® RapidCreepPositioning Drive



Functional description

The MOVIKIT® RapidCreepPositioning Drive software module allows you to implement classic "rapid/creep speed positioning" without a motor encoder. Positioning is performed by means of initiators used for changing from fast to slow speed or for activating stop deceleration. Positioning applications in two directions are also possible and additional optional sensors can be used. No programming knowledge is required for startup and diagnostics as the software module is integrated in the MOVISUITE® engineering software.

Overview of functions:

- Startup using a graphical user interface
- Dedicated parameter tree with all the parameters that are required for operation
- Provision of the following operating modes:
 - Jog mode
 - Referencing mode
 - Different operating modes for infeed
 - Outfeed
 - Reverse mode
- Diagnostic monitor for monitoring and controlling the axis
- Standardized process data interface

For more information, refer to the associated → manual.

Project planning notes	
License type	Single license
Required application level	Application level 1
Hardware requirements	The software module is compatible with the following hardware: <ul style="list-style-type: none"> • MOVIDRIVE® technology • MOVIGEAR® performance • MOVIMOT® performance • MOVIMOT® advanced • MOVIMOT® flexible • MOVITRAC® advanced
Type code, part number	SMK1007-000, 23372370

6.3.4 MOVIKIT® Velocity Drive



Functional description

The MOVIKIT® Velocity Drive software module allows for implementing applications with velocity control and a predefined fieldbus interface. The software module mainly uses the basic functions of the application inverter in use by activating the respective function blocks (such as FCB09 "Position control") depending on the application. This means the scope of functions depends on the application inverter (e.g. with or without encoder feedback).

Overview of functions:

- Startup using a graphical user interface
- Dedicated parameter tree with all the parameters that are required for operation
- Provision of the "velocity control" operating mode
- Additional functions: variable jerk time, parameter channel via process data
- Diagnostic monitor for monitoring and controlling the axis
- Standardized process data interface

For more information, refer to the associated → [manual](#).

Project planning notes	
License type	Single license
Required application level	Application level 0
Hardware requirements	<p>The software module is compatible with the following hardware:</p> <ul style="list-style-type: none"> • MOVIDRIVE® technology • MOVIGEAR® performance • MOVIMOT® performance • MOVIMOT® advanced • MOVIMOT® flexible • MOVITRAC® advanced
Type code, part number	SMK1001-000, 23371455

6.4 Category "Energy Recovery"

The category "EnergyRecovery" includes MOVIKIT® software modules that can be used to implement energy supply solutions with the new block or sinusoidal energy recovery module MDR9.B-...

6.4.1 MOVIKIT® EnergyRecovery



Functional description

The MOVIKIT® EnergyRecovery software module provides functions for controlling the MDR90B and MDR91B supply units via the MOVI-C® CONTROLLER or a higher-level controller. In addition, measured and status values are provided both at IEC level and via the fieldbus interface.

Overview of functions:

- Operating the MDR90B and MDR91B supply units via the IEC application program
- Transferring measured and status values to the MOVI-C® CONTROLLER and the higher-level controller
- Possibility of activating the two operating modes FCB 53 and FCB 58
- Standardized process data interface to the customer

Project planning notes	
License type	Performance license
Hardware requirements	The software module is compatible with the following hardware: MOVI-C® CONTROLLER (all performance classes)
Additionally required licenses	MOVIRUN® flexible
Type code, part number	SMK2101, 23373393

6.5 Category "Motion"

The category "Motion" includes MOVIKIT® software modules that provide specific motion control functions. The category also includes add-ons that can also be used for software modules of other categories, e.g. MOVIKIT® Motion add-on AntiSway.

6.5.1 MOVIKIT® EncoderInterface



Functional description

The MOVIKIT® EncoderInterface software module is used to convert data from an external source (e.g. an external encoder directly connected via EtherCAT® or any variable) from system units into user units. Both a modulo and a numerator/denominator processing of the synchronized data can be performed. In addition, the scope of functions includes the possibility of referencing and provides fail-safe offset and remainder management.

Overview of functions:

- Processing of modulo overflow in the data source
- Conversion of external data to LREAL with appropriate resolution (e.g. encoder connected to the inverter and user units configured on the inverter)
- Scaling of output variables (e.g. encoder connected to EtherCAT® and scaling of user units on the MOVI-C® CONTROLLER)
- Calculation of the derivatives to determine speed and acceleration
- Activation of filters for smoothing the data
- Consistent fail-safe storage of division remainders
- Consistent fail-safe storage of variables
- Dead time compensation

For more information, refer to the associated → manual.

Project planning notes	
License type	Included in the license for MOVIRUN® flexible
Hardware requirements	The software module is compatible with the following hardware: MOVI-C® CONTROLLER (all performance classes)
Additionally required licenses	MOVIRUN® flexible
Type code, part number	<ul style="list-style-type: none"> • SMR0001-020, 23371358 • SMR0001-040, 23371366 • SMR0001-060, 23371676 • SMR0001-080, 23371307

6.5.2 MOVIKIT® Motion add-on AntiSway

Functional description

The MOVIKIT® Motion add-on AntiSway software module extends the scope of functions of the MOVIKIT® MultiMotion, MOVIKIT® MultiMotion Camming and the MOVIKIT® MultiAxisController software modules by a function for suppressing vibrations in the drive train. Using this function makes it possible to suppress vibrations with a dominant resonant frequency. Even variable resonant frequencies can be suppressed in certain operating modes of the MOVIKIT® Motion add-on AntiSway software module. Without evaluating a sensor, the MOVIKIT® Motion add-on AntiSway software module generates additive correction signals on the conventional travel profile that prevent vibration from occurring on the parameterized mechanical system.

The MOVIKIT® Motion add-on AntiSway software module supports the following types of application:

- TowerSway
- BellySway
- SpringSway
- PendulumSway
- FluidSway

The following graphic shows an example of the course of speed and acceleration of a drive train without (blue curve) and with (green curve) MOVIKIT® Motion add-on AntiSway software module:

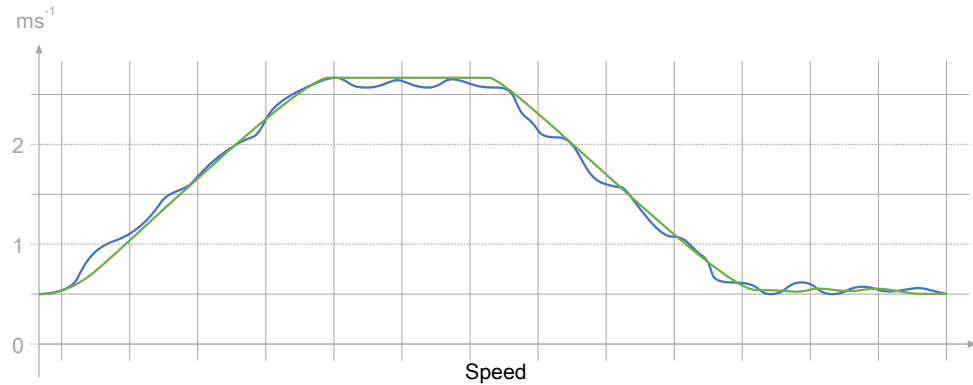

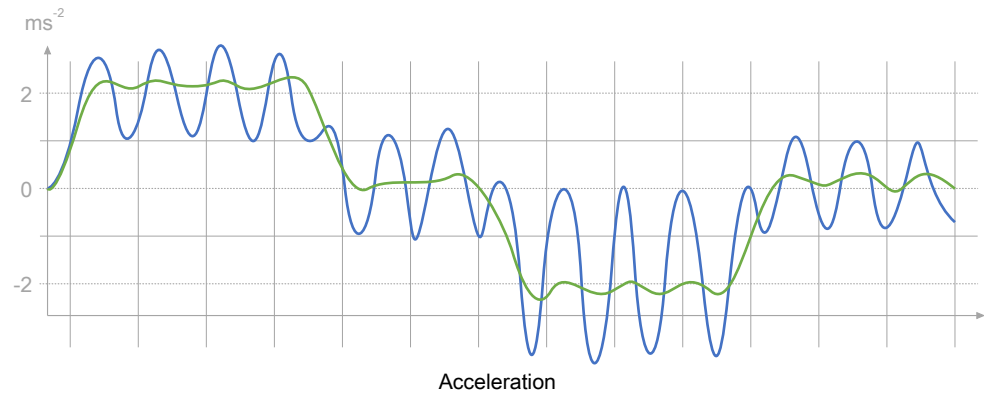

Project planning notes	
License type	Single license
Hardware requirements	<p>The software module is compatible with the following hardware:</p> <ul style="list-style-type: none"> • MOVI-C® CONTROLLER (all performance classes) • MOVIDRIVE® modular (as an interpolating device) • MOVIDRIVE® system (as an interpolating device) • MOVIDRIVE® technology (as an interpolating device) <p>If you want to use Generation C devices such as MOVITRAC®, MOVIGEAR® or MOVIMOT®, contact SEW-EURODRIVE.</p> <p>Make sure that the cycle time on the MOVI-C® CONTROLLER and on the inverters is set to <2 ms. Otherwise, contact SEW-EURODRIVE.</p>
Additionally required licenses	<p>One of the following combinations:</p> <ul style="list-style-type: none"> • MOVIRUN® flexible, MOVIKIT® add-on PositionController • MOVIRUN® flexible, MOVIKIT® MultiAxisController • MOVIRUN® flexible, MOVIKIT® Gearing, MOVIKIT® add-on PositionController • MOVIRUN® flexible, MOVIKIT® StackerCrane MultiAxisController
Type code, part number	SMK0008-000, 23371846

6.6 Category "MultiAxisController"

The category "MultiAxisController" includes MOVIKIT® software modules for centrally controlling any number of mechanically coupled drives.

6.6.1 MOVIKIT® MultiAxisController



Functional description

The MOVIKIT® MultiAxisController software module allows for implementing mechanically coupled drives (loose or rigid coupling) by means of a software module. It is possible to choose between correcting skewing and equalizing the torque of two drives. Licenses are available for using each of the various operating modes.

The software module replaces conventional master-slave operation and offers an expanded scope of functions compared to position-synchronous master/slave operation. The following functions are available both in the torque mode "Torque priority" (→ 50) and the skewing mode "Skew priority" (→ 51):

- Central control of referencing, limit switch evaluation and error handling for one axis group
- Central position control (slip compensation via distance encoder also possible)
- Use of a virtual master in the operating modes relative or absolute positioning, velocity control and direct coupling (MOVIKIT® MultiMotion software module)
- Provision of the camming operating mode, in which the axis group follows a master signal in synchronization with a curve
- Combined encoder evaluation, see "MOVIKIT® MultiMotion add-on CombinedEncoderEvaluation" (→ 63)
- Central position control and conventional encoder evaluation, see chapter "MOVIKIT® MultiMotion add-on PositionController" (→ 62)
- Standardized fieldbus interface can be activated. The basic functions of the interface (e.g. enable, movement) correspond to those of the MOVIKIT® Positioning software module. Additional process data of the MOVIKIT® MultiAxisController software module (e.g. desired tension, mast vibration suppression) can be selected and added variably.

For more information, refer to the associated → manual.

Project planning notes	
License type	Single license
Hardware requirements	<p>The software module is compatible with the following hardware:</p> <ul style="list-style-type: none"> • MOVI-C® CONTROLLER (all performance classes) • MOVIDRIVE® modular (as an interpolating device) • MOVIDRIVE® system (as an interpolating device) • MOVIDRIVE® technology (as an interpolating device) <p>If you want to use Generation C devices such as MOVITRAC®, MOVIGEAR® or MOVIMOT®, contact SEW-EURODRIVE.</p> <p>Make sure that the cycle time on the MOVI-C® CONTROLLER and on the inverters is set to ≤2 ms. When using the MOVIKIT® add-on AntiSway software module, the cycle time must be set to <2 ms. Otherwise, contact SEW-EURODRIVE.</p>

Additionally required licenses	MOVIRUN® flexible
Type code, part number	<ul style="list-style-type: none">• SMK1201-000 (torque mode), 23371897• SMK1202-000 (skewing mode), 23371900• SMK1203-000 (torque and skewing mode), 23371919

6.6.2 MOVIKIT® MultiAxisController Torque

**Functional description**

The MOVIKIT® MultiAxisController Torque software module implements the compensation of torque between mechanically coupled drives ("Torque priority" operating mode).

Overview of functions:

- Synchronism with torque distribution
- Torque distribution
- Load distribution
- Rigid coupling of the drives (formerly torque/slave)
- Load balancing (formerly master/slave)
- Speed synchronism
- Torque follower
- Torque coupling
- Load distribution between drives can be configured online
- Tension between drives can be configured online
- Electronic differential
- Parameterizable differential lock
- ASR (replaces the generation B ASR software)
- Deactivation of any axis group element for maintenance purposes

For more information, refer to the associated → [manual](#).

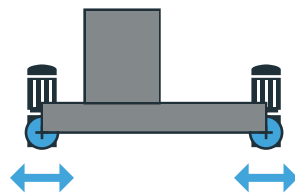

Transport-optimized trolleys



Indexing table

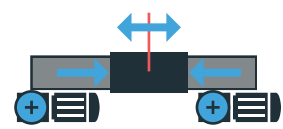

Gripper, centering unit

Project planning notes	
License type	Single license
Hardware requirements	The software module is compatible with the following hardware: MOVI-C® CONTROLLER (all performance classes)
Additionally required licenses	MOVIRUN® flexible
Type code, part number	SMK1201-000, 23371897

6.6.3 MOVIKIT® MultiAxisController Skewing



Functional description

The MOVIKIT® MultiAxisController Skewing software module implements the correction of a skew between mechanically coupled drives ("Skew priority" operating mode).

Overview of functions:

- Phase-synchronous operation
- Adjustment function can be used continuously
- Overload guard: Prevents asynchronicity in the event of a failure
- Solution for the following problems:
 - Loosely coupled drives
 - Double spindle drives that tilt or jam quickly when in a different position
- Replacement for the following features of generation B devices:
 - Master/slave synchronous operation (1:1 gear ratio)
 - FCB 22 Multi-drive
 - SyncCrane – functional replacement
 - DriveSync – functional replacement at a gear ratio of 1:1

For more information, refer to the associated → [manual](#).

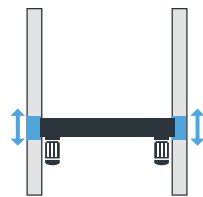

Indoor crane, gantry

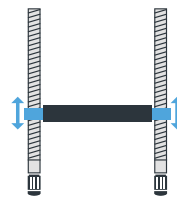

Parallel feed

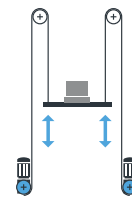

Dual-column hoist, SRS vertical drive

Project planning notes	
License type	Single license
Hardware requirements	The software module is compatible with the following hardware: MOVI-C® CONTROLLER (all performance classes)
Additionally required licenses	MOVIRUN® flexible
Type code, part number	SMK1202-000, 23371900

6.6.4 MOVIKIT® MultiAxisController add-on FourAxes



Functional description

The MOVIKIT® MultiAxisController add-on FourAxes software module extends the scope of functions of the MOVIKIT® MultiAxisController software module by the possibility of controlling up to 4 drives. For more information, refer to the associated → [manual](#).

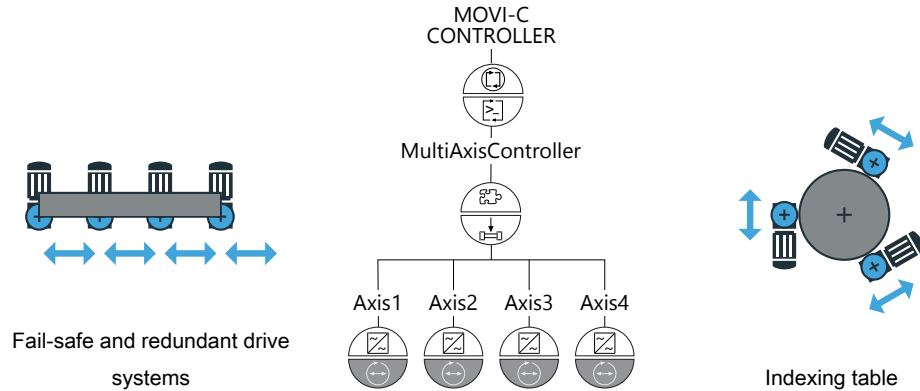

Project planning notes	
License type	Single license
Hardware requirements	The software module is compatible with the following hardware: <ul style="list-style-type: none"> • MOVI-C® CONTROLLER progressive UHX65A • MOVI-C® CONTROLLER power UHX85A
Additionally required licenses	<ul style="list-style-type: none"> • MOVIRUN® flexible • MOVIKIT® MultiAxisController
Type code, part number	SMK1204-000, 23371927

6.6.5 MOVIKIT® MultiAxisController add-on Cascading



Functional description

The MOVIKIT® MultiAxisController add-on Cascading software module extends the scope of functions of the MOVIKIT® MultiAxisController by the option of operating several axis groups in a cascade. Cascading is required, for example, if each side of a gantry crane is equipped with two drives. In this case, each side of the gantry crane should be operated separately in the "Torque priority" (→ 50) operating mode and both sides should be operated together in the "Skew priority" (→ 51) operating mode. For more information, refer to the associated → manual.

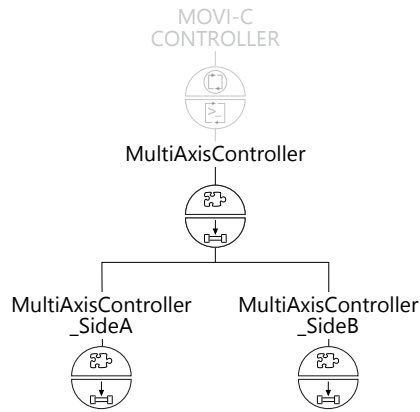

Project planning notes	
License type	Single license
Hardware requirements	The software module is compatible with the following hardware: <ul style="list-style-type: none"> • MOVI-C® CONTROLLER progressive UHX65A • MOVI-C® CONTROLLER power UHX85A
Additionally required licenses	<ul style="list-style-type: none"> • MOVIRUN® flexible • MOVIKIT® MultiAxisController
Type code, part number	SMK1205-000, 23371935

6.7 Category "MultiMotion"

The category "MultiMotion" includes MOVIKIT® software modules for implementing universal motion control functions for interpolating axes. A defined IEC interface can be used to activate and, for example, overlay motion profiles.

6.7.1 MOVIKIT® MultiMotion



Functional description

The MOVIKIT® MultiMotion software module provides universal motion functions for interpolating axes. Various time or master based motion profiles can be activated conveniently by means of a defined IEC interface. The motion profiles can also be overlaid.

Overview of functions:

- Configuration via graphical user interfaces in the MOVISUITE® engineering tool or via the user program
- Provision of motion functions for interpolating axes
- Time-based motion profiles: Speed control, relative and absolute positioning, jog mode
- Master-based motion profiles: Direct coupling
- Overlaying motion profiles
- Axis-based and profile-based (on-the-fly) referencing
- Provision of a touchprobe function
- Configuration of virtual axes

For more information, refer to the associated → manual.

Project planning notes	
License type	Included in the license for MOVIRUN® flexible
Hardware requirements	<p>The software module is compatible with the following hardware:</p> <ul style="list-style-type: none"> • MOVI-C® CONTROLLER (all performance classes) • MOVIDRIVE® modular (as an interpolating device) • MOVIDRIVE® system (as an interpolating device) • MOVIDRIVE® technology (as an interpolating device) <p>If you want to use Generation C devices such as MOVITRAC®, MOVIGEAR® or MOVIMOT®, contact SEW-EURODRIVE.</p>
Additionally required licenses	MOVIRUN® flexible
Type code, part number	<ul style="list-style-type: none"> • SMR0001-020, 23371358 • SMR0001-040, 23371366 • SMR0001-060, 23371676 • SMR0001-080, 23371307

6.7.2 MOVIKIT® MultiMotion Gearing



Functional description

The MOVIKIT® MultiMotion Gearing software module is based on the MOVIKIT® MultiMotion software module and extends its scope of functions by position-dependent synchronous operation between two or more axes.

Overview of functions:

- Configuration via graphical user interfaces in the MOVISUITE® engineering tool or via the user program
- Provision of motion functions for interpolating axes
 - Time-based motion profiles: Speed control, relative and absolute positioning, jog mode
 - Master-based motion profiles: Direct coupling, synchronous operation
- Overlaying motion profiles
- Axis-based and profile-based (on-the-fly) referencing
- Provision of a touchprobe function
- Configuration of virtual axes
- Position and time-dependent engagement/disengagement mechanisms and offset processing
- Provision of an adjustment function

For more information, refer to the associated → [manual](#).

Project planning notes	
License type	Performance license
Hardware requirements	The software module is compatible with the following hardware: <ul style="list-style-type: none"> • MOVI-C® CONTROLLER (all performance classes) • MOVIDRIVE® modular (as an interpolating device) • MOVIDRIVE® system (as an interpolating device) • MOVIDRIVE® technology (as an interpolating device) If you want to use Generation C devices such as MOVITRAC®, MOVIGEAR® or MOVIMOT®, contact SEW-EURODRIVE.
Additionally required licenses	<ul style="list-style-type: none"> • MOVIRUN® flexible
Type code, part number	<ul style="list-style-type: none"> • SMK0011-020, 23372710 • SMK0011-040, 23372729 • SMK0011-060, 23372737 • SMK0011-080, 23372745

6.7.3 MOVIKIT® MultiMotion Camming



Functional description

The MOVIKIT® MultiMotion Camming software module is based on the MOVIKIT® MultiMotion software module and extends its scope of functions by an electronic cam as a master-based motion profile.

Overview of functions:

- Configuration via graphical user interfaces in the MOVISUITE® engineering tool or via the user program
- Provision of motion functions for interpolating axes
 - Time-based motion profiles: Speed control, relative and absolute positioning, jog mode
 - Master-based motion profiles: Direct coupling, synchronous operation, electronic cam
- Overlaying motion profiles
- Axis-based and profile-based (on-the-fly) referencing
- Provision of a touchprobe function
- Configuration of virtual axes
- Online configuration of curve descriptions
- Processing of curve function descriptions created with the MOVISUITE® CamEditor, see "MOVISUITE® CamEditor" (→ 30).
- Automatic engagement/disengagement mechanisms
- Phase and amplitude correction on the fly
- Curve changeover on the fly
- Provision of an adjustment function
- Configuration of user-specific profiles

For more information, refer to the associated → [manual](#).

Project planning notes	
License type	Performance license
Hardware requirements	<p>The software module is compatible with the following hardware:</p> <ul style="list-style-type: none"> • MOVI-C® CONTROLLER (all performance classes) • MOVIDRIVE® modular (as an interpolating device) • MOVIDRIVE® system (as an interpolating device) • MOVIDRIVE® technology (as an interpolating device) <p>If you want to use Generation C devices such as MOVITRAC®, MOVIGEAR® or MOVIMOT®, contact SEW-EURODRIVE.</p>
Additionally required licenses	MOVIRUN® flexible
Type code, part number	<ul style="list-style-type: none"> • SMK0001-020, 23371374 • SMK0001-040, 23371382 • SMK0001-060, 23371714 • SMK0001-080, 23371323

6.7.4 MOVIKIT® MultiMotion Camming add-on AntiSlosh



Functional description

The MOVIKIT® MultiMotion Camming add-on AntiSlosh software module extends the scope of functions of the MOVIKIT® MultiMotion Camming software module by a function for generating travel profiles to reduce oscillations in the cyclical movement of liquids. Configuration can be performed via graphical user interfaces of the MOVISUITE® engineering tool or via the user program.

6

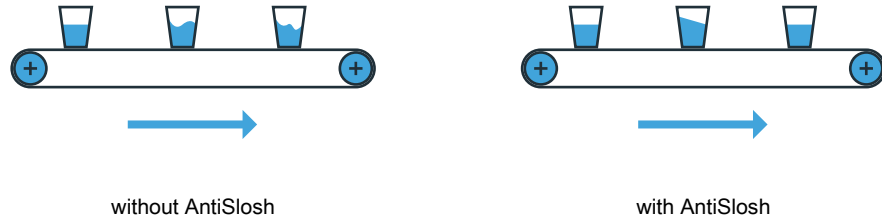

Project planning notes	
License type	Performance license
Hardware requirements	<p>The software module is compatible with the following hardware:</p> <ul style="list-style-type: none"> • MOVI-C® CONTROLLER (all performance classes) • MOVIDRIVE® modular (as an interpolating device) • MOVIDRIVE® system (as an interpolating device) • MOVIDRIVE® technology (as an interpolating device) <p>If you want to use Generation C devices such as MOVITRAC®, MOVIGEAR® or MOVIMOT®, contact SEW-EURODRIVE.</p>
Additionally required licenses	MOVIRUN® flexible
Type code, part number	<ul style="list-style-type: none"> • SMK0013-020, 23372834 • SMK0013-040, 23372842 • SMK0013-060, 23372850 • SMK0013-080, 23372869

6.7.5 MOVIKIT® MultiMotion Camming add-on Interpolation



Functional description

The MOVIKIT® MultiMotion Camming add-on Interpolation software module extends the scope of functions of the MOVIKIT® MultiMotion Camming by a function for generating travel profiles based on the interpolation of curve point tables. With linear or cubic interpolation, up to 1024 curve points can be interpolated, and with spline interpolation, up to 64 curve points can be interpolated. Curve point tables can either be stored as ASCII files on the memory card of the MOVI-C® CONTROLLER or generated directly from the user program.

Curve point table and representation of curve points in a diagram:

Master X-Axis	Slave Y-Axis
0	0
0.125	12.5
0.25	50
0.375	87.5
0.5	100
0.625	87.5
0.75	50
0.875	12.5
1	0

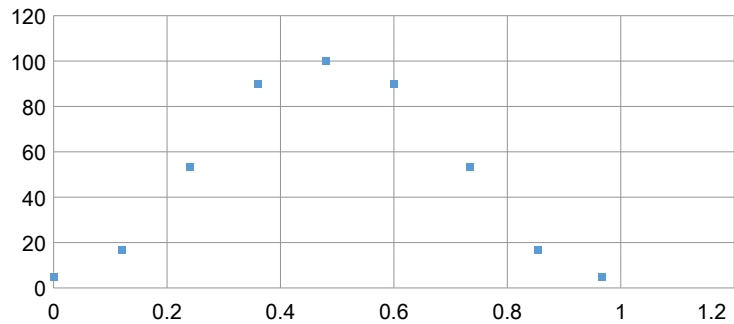

Example curve profiles with cubic interpolation of these curve points:

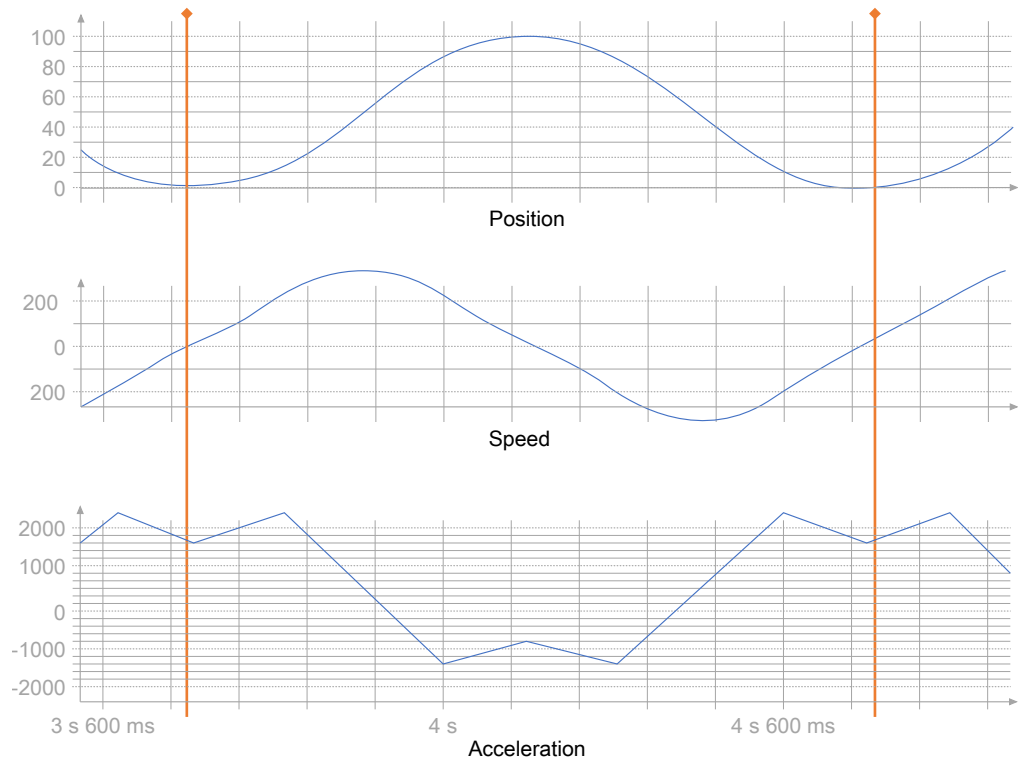

Project planning notes	
License type	Performance license
Hardware requirements	<p>The software module is compatible with the following hardware:</p> <ul style="list-style-type: none"> • MOVI-C® CONTROLLER (all performance classes) • MOVIDRIVE® modular (as an interpolating device) • MOVIDRIVE® system (as an interpolating device) • MOVIDRIVE® technology (as an interpolating device) <p>If you want to use Generation C devices such as MOVITRAC®, MOVIGEAR® or MOVIMOT®, contact SEW-EURODRIVE.</p>
Additionally required licenses	MOVIRUN® flexible
Type code, part number	<ul style="list-style-type: none"> • SMK0012-020, 23372761 • SMK0012-040, 23372788 • SMK0012-060, 23372796 • SMK0012-080, 23372818

6.7.6 MOVIKIT® MultiMotion Auxiliary Velocity



Functional description

The MOVIKIT® MultiMotion Auxiliary Velocity software module allows for configuring speed setpoints and torque specifications for non-interpolating axes. The software module is particularly suited for controlling auxiliary axes in simple applications (e.g. conveyor belts).

Overview of functions:

- Speed setpoint
- Torque specification

For more information, refer to the associated → [manual](#).

Project planning notes	
License type	Included in the license for MOVIRUN® flexible
Hardware requirements	<p>The software module is compatible with the following hardware:</p> <ul style="list-style-type: none"> • MOVI-C® CONTROLLER • MOVIDRIVE® modular • MOVIDRIVE® system • MOVIDRIVE® technology <p>If you want to use Generation C devices such as MOVITRAC®, MOVIGEAR® or MOVIMOT®, contact SEW-EURODRIVE.</p>
Additionally required licenses	MOVIRUN® flexible
Type code, part number	<ul style="list-style-type: none"> • SMR0001-020, 23371358 • SMR0001-040, 23371366 • SMR0001-060, 23371676 • SMR0001-080, 23371307

6.7.7 MOVIKIT® MultiMotion Auxiliary Positioning



Functional description

The MOVIKIT® MultiMotion Auxiliary Positioning software module allows for configuring positioning as well as speed setpoints and torque specifications for non-interpolating axes. The software module is particularly suited for controlling auxiliary axes in simple applications (e.g. variable-speed drives).

Overview of functions:

- Speed setpoint
- Torque specification
- Positioning
- Referencing

For more information, refer to the associated → [manual](#).

Project planning notes	
License type	Included in the license for MOVIRUN® flexible
Hardware requirements	<p>The software module is compatible with the following hardware:</p> <ul style="list-style-type: none"> • MOVI-C® CONTROLLER • MOVIDRIVE® modular • MOVIDRIVE® system • MOVIDRIVE® technology <p>If you want to use Generation C devices such as MOVITRAC®, MOVIGEAR® or MOVIMOT®, contact SEW-EURODRIVE.</p>
Additionally required licenses	MOVIRUN® flexible
Type code, part number	<ul style="list-style-type: none"> • SMR0001-020, 23371358 • SMR0001-040, 23371366 • SMR0001-060, 23371676 • SMR0001-080, 23371307

6.7.8 MOVIKIT® MultiMotion add-on PositionController



Functional description

The MOVIKIT® MultiMotion add-on PositionController software module extends the scope of functions of a MOVIKIT® software module (e.g. MOVIKIT® MultiMotion) by central position control and conventional encoder evaluation. If the MOVIKIT® MultiMotion add-on PositionController software module is used in combination with the MOVIKIT® MultiMotion add-on "CombinedEncoderEvaluation" (→ 63) software module, a combined encoder evaluation can be used as the data source, see the following illustration.

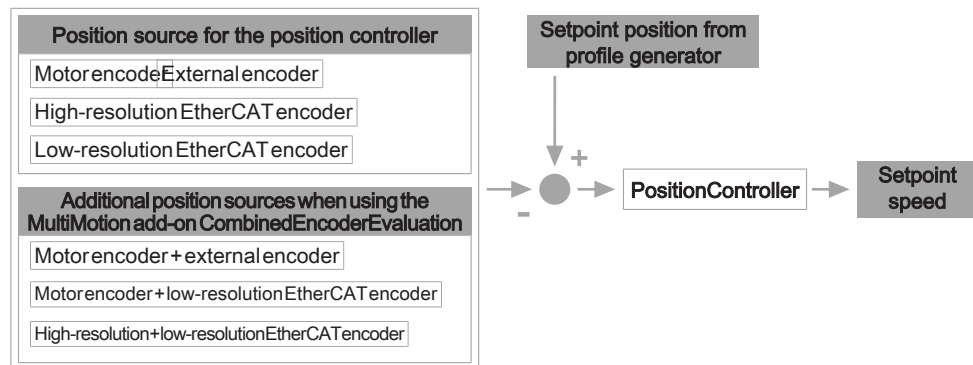

Project planning notes	
License type	Performance license
Hardware requirements	<p>The software module is compatible with the following hardware:</p> <ul style="list-style-type: none"> • MOVI-C® CONTROLLER (all performance classes) • MOVIDRIVE® modular (as an interpolating device) • MOVIDRIVE® system (as an interpolating device) • MOVIDRIVE® technology (as an interpolating device) <p>If you want to use Generation C devices such as MOVITRAC®, MOVIGEAR® or MOVIMOT®, contact SEW-EURODRIVE.</p> <p>Make sure that the cycle time on the MOVI-C® CONTROLLER and on the inverters is set to ≤2 ms. Otherwise, contact SEW-EURODRIVE.</p>
Additionally required licenses	MOVIRUN® flexible
Type code, part number	<ul style="list-style-type: none"> • SMK0006-020, 23371722 • SMK0006-040, 23371730 • SMK0006-060, 23371749 • SMK0006-020, 23371722

6.7.9 MOVIKIT® MultiMotion add-on CombinedEncoderEvaluation



Functional description

The MOVIKIT® MultiMotion add-on CombinedEncoderEvaluation software module extends the scope of functions of a MOVIKIT® software module (e.g. MultiMotion) by a combined encoder evaluation. This combined encoder evaluation makes it possible to combine a high-resolution motor encoder with a low-resolution distance encoder subject to dead time. The low-resolution distance encoder reliably guarantees the reference to the machine even in the event of non-positive connections between the motor and the machine. The MOVIKIT® MultiMotion add-on CombinedEncoderEvaluation software module generates a machine-related, high-resolution encoder signal that can be used dynamically.

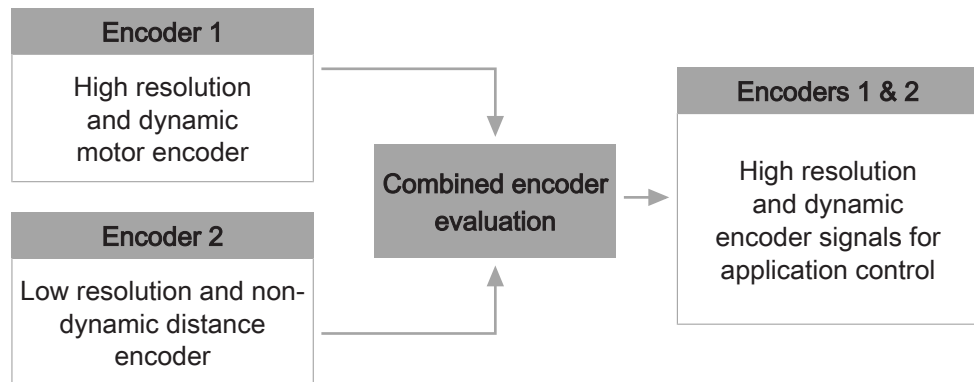

Project planning notes	
License type	Performance license
Hardware requirements	<p>The software module is compatible with the following hardware:</p> <ul style="list-style-type: none"> • MOVI-C® CONTROLLER (all performance classes) • MOVIDRIVE® modular (as an interpolating device) • MOVIDRIVE® system (as an interpolating device) • MOVIDRIVE® technology (as an interpolating device) <p>If you want to use Generation C devices such as MOVITRAC®, MOVIGEAR® or MOVIMOT®, contact SEW-EURODRIVE.</p> <p>Make sure that the cycle time on the MOVI-C® CONTROLLER and on the inverters is set to ≤2 ms. Otherwise, contact SEW-EURODRIVE.</p>
Additionally required licenses	MOVIRUN® flexible
Type code, part number	<ul style="list-style-type: none"> • SMK0007-020, 23371773 • SMK0007-040, 23371781 • SMK0007-060, 23371803 • SMK0007-080, 23371838

26876124/EN – 08/2021

6.8 Category "Power and Energy Solutions"

The category "Power and Energy Solutions" includes energy supply solutions for inverters of the MOVIDRIVE® modular series.

6.8.1 MOVIKIT® Power and Energy Solutions DirectMode



Functional description

The MOVIKIT® Power and Energy Solutions DirectMode software module together with an MDP92A power supply module or MDE90A energy converter from the "Power and Energy Solutions" product series allows for simple, programmable power supply for MOVIDRIVE® modular inverters. The MOVIKIT® Power and Energy Solutions DirectMode software module is particularly suited for applications without energy storage.

Overview of functions:

- Communication of the MOVI-C® CONTROLLER with the MDP92A power supply module and the MDE90A energy converter
- Acquisition of the power ratings for the grid supply and axis module
- Acquisition of the power ratings from 24 V consumers (via MDS90A) and external AC consumers
- Dynamically adjustable maximum AC or DC grid supply power rating
- Dynamically adjustable current limiting
- Dynamically adjustable DC link voltage (up to 800 V)
- Provision of status information (phase failure and power failure, external conductor voltages, and phase current) for the AC grid (MDP92A only)
- Fieldbus interface for communication with higher-level controllers

For more information, refer to the associated → [manual](#).

The following figure shows the application case of the MOVIKIT® Power and Energy Solutions DirectMode software module with MDP92A power supply module and MOVIDRIVE® modular axis module:

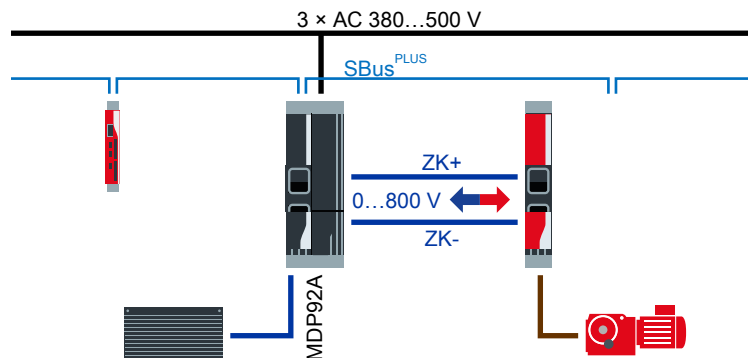

Project planning notes

License type	Included in the license for MOVIRUN® flexible
--------------	---

Project planning notes	
Hardware requirements	The software module is compatible with the following hardware: MOVI-C® CONTROLLER (all performance classes)
Additionally required licenses	MOVIRUN® flexible
Type code, part number	<ul style="list-style-type: none"> • SMR0001-020, 23371358 • SMR0001-040, 23371366 • SMR0001-060, 23371676 • SMR0001-080, 23371307

6.8.2 MOVIKIT® Power and Energy Solutions EnergyMode



Functional description

The MOVIKIT® Power and Energy Solutions EnergyMode software module enables highly efficient energy supply solutions with energy storage decoupled from the DC link and simple supply from the AC grid (bridge rectifier). The energy storage unit is not connected to the DC link directly, but rather via an MDE90A energy converter from the "Power and Energy Solutions" product series. This opens up advantages with regard to a deeper storage discharge and smaller storage design. Software support on the control level is provided by the MOVIKIT® Power and Energy Solutions EnergyMode software module.

Overview of functions:

- Communication of the MOVI-C® CONTROLLER with the MDE90A energy converter
- Dynamically adjustable DC link voltage (up to 800 V) and state of charge including definition of the work envelope
- Recuperation detection for optimized storage utilization
- Variable control regarding DC link or memory with dynamically adjustable power or current limitation
- Acquisition of axis module power rating and memory power rating
- Acquisition of the power ratings from 24 V consumers (via MDS90A) and external AC consumers
- Monitoring of the energy storage units by querying via the diagnostic interfaces (for example the current temperature of the storage unit or signals for overtemperature and overvoltage)
- Automatic synchronization and activation of the energy storage unit
- Fieldbus interface for communication with higher-level controllers

For more information, refer to the associated → [manual](#).

The following figure shows the application case of the MOVIKIT® Power and Energy Solutions EnergyMode with conventional MDP90A power supply module, MDE90A energy converter and MOVIDRIVE® modular axis module:

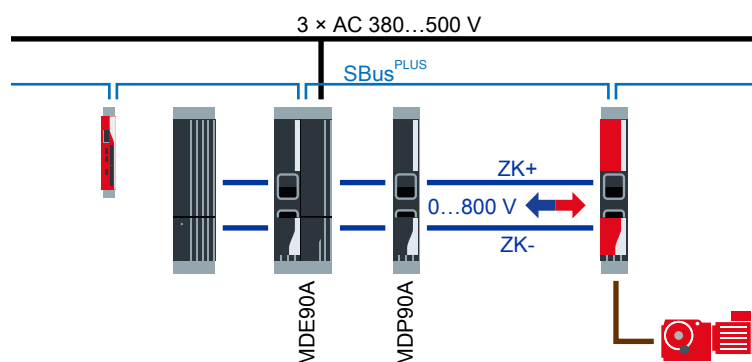

Project planning notes

License type	Performance license
--------------	---------------------

Project planning notes	
Hardware requirements	The software module is compatible with the following hardware: MOVI-C® CONTROLLER (all performance classes)
Additionally required licenses	MOVIRUN® flexible
Type code, part number	<ul style="list-style-type: none"> • SMK1403-020, 23372923 • SMK1403-040, 23372931 • SMK1403-060, 23372958 • SMK1403-080, 23372966

6.8.3 MOVIKIT® Power and Energy Solutions PowerMode



Functional description

The MOVIKIT® Power and Energy Solutions PowerMode software module provides, together with an MDP92A power supply module or MDE90A energy converter from the "Power and Energy Solutions" product series as well as additional energy storage units, the possibility for modularly creating highly-efficient energy supply solutions for MOVIDRIVE® modular inverters. This MOVIKIT® software module is therefore particularly designed for applications with energy storage units that are directly switched in the DC link. The MOVIKIT® Power and Energy Solutions PowerMode software module provides the scope of functions of the MOVIKIT® Power and Energy Solutions DirectMode software module plus the extensions for the described application.

Overview of additional functions:

- Dynamically adjustable state of charge of the storage unit including specification of the work envelope
- Recuperation detection for optimized storage utilization
- Power-regulated discharge for the DC link (only MDP92A)
- Automatic synchronization and activation of the energy storage unit
- Monitoring of the energy storage units by querying via the diagnostic interfaces (depending on the interface, for example current storage unit temperature or signals for overtemperature and overvoltage)
- Fieldbus interface for communication with higher-level controllers
- Determination of remaining runtime after power failure

For more information, refer to the associated → manual.

The following figure shows the application case of the MOVIKIT® Power and Energy Solutions PowerMode software module with MDP92A power supply module, MOVIDRIVE® modular axis module and energy storage unit:

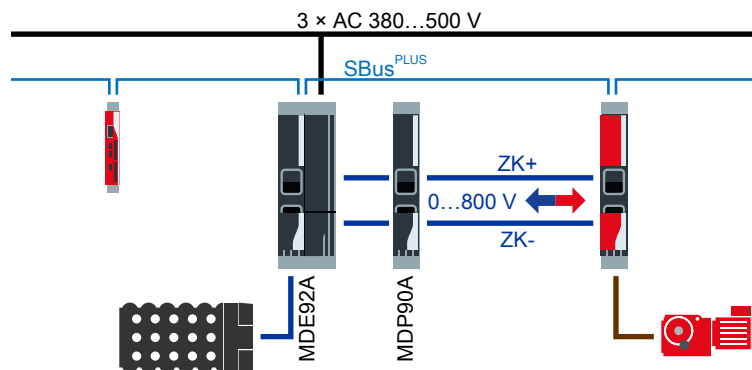

Project planning notes	
License type	Performance license
Hardware requirements	The software module is compatible with the following hardware: MOVI-C® CONTROLLER (all performance classes)

Project planning notes	
Additionally required licenses	MOVIRUN® flexible
Type code, part number	<ul style="list-style-type: none">• SMK1402-020, 23372435• SMK1402-040, 23372443• SMK1402-060, 23372451• SMK1402-080, 23372478

6.9 Category "Robotics"

The category "Robotics" includes MOVIKIT® software modules for controlling robots.

6.9.1 MOVIKIT® Robotics



Functional description

The MOVIKIT® Robotics software module is the basic software module for controlling a robot and makes available a wide range of models for configuring robots, e.g. for specifying dimensions. The focus of the software module is on handling applications, such as palletizing or transferring goods. Processing tasks, such as plotting, applying glue, or decorating are also possible.

Overview of functions:

- Simple operation via the MOVISUITE® RobotMonitor (e.g. through 3D simulation), IEC program, or process data interface.
- Predefined kinematic models with 2 joint axes (e.g. gantry robot, delta robot, roller gantry, SCARA, mixed designs)
- Storage of 20 programs with several 100 motion commands per program
- Additional programs without size limitation
- Manual mode (jog single axes/joint axes/Cartesian, program) and automatic mode (program)
- Control in step mode (set, movement)
- Override function
- Tool transformation
- Linear interpolation with jerk-limited blending
- PTP interpolation
- Use of explicit coordinates or variable poses
- Use of BOOL, REAL or POSE variables with integration in IEC program
- Control structures (IF, WHILE)
- Call functions (for the synchronized execution of IEC code)
- Calling of subprograms
- Path events position based, time based, or combined
- Can be combined with the MOVIKIT® MultiAxisController software module and its add-ons, e.g. for applications in which several drives are driving one joint axis.
- Export of force-torque curves for the project planning of drives in SEW-Workbench

For more information, refer to the associated → [manual](#).

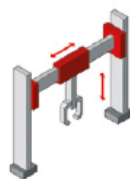

Gantry robots



Delta robots

Project planning notes	
License type	Single license
Hardware requirements	The software module is compatible with the following hardware: MOVI-C® CONTROLLER (all performance classes)
Additionally required licenses	MOVIRUN® flexible
Type code, part number	SMK1101-000, 23371862

6.9.2 MOVIKIT® Robotics add-on MediumModels



Functional description

The MOVIKIT® Robotics add-on MediumModels software module extends the scope of functions of the MOVIKIT® Robotics software module by the option of configuring kinematic models with 3 or 4 joint axes. This includes the following kinematic models:

- Gantry robots
- Roller Gantry
- Delta robots
- Tripod
- SCARA
- Mixed designs

The scope of functions includes the matching 3D visualizations of the kinematic models. For more information, refer to the associated → [manual](#).

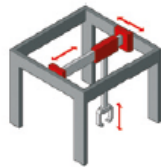

x/y/z gantry

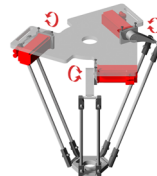

Tripod



SCARA

Project planning notes

License type	Single license
Hardware requirements	The software module is compatible with the following hardware: MOVI-C® CONTROLLER (all performance classes)
Additionally required licenses	<ul style="list-style-type: none"> • MOVIRUN® flexible • MOVIKIT® Robotics
Type code, part number	SMK1102-000, 23371870

6.9.3 MOVIKIT® Robotics add-on LargeModels



Functional description

The MOVIKIT® Robotics add-on LargeModels software module extends the scope of functions of the MOVIKIT® Robotics software module by the option of configuring kinematic models with 5 or 6 joint axes or at least 2 orientation degrees of freedom. This comprises kinematic models of all types. The scope of functions includes the matching 3D visualizations of the kinematic models. The license for the MOVIKIT® Robotics add-on LargeModels software module and the associated LargeModels control software (available on USB stick) are taken from the currently valid lists of goods (Annex I DUVO 428/2009), list number: 2D002. For more information, refer to the associated → manual.

Project planning notes	
License type	Single license
Hardware requirements	The software module is compatible with the following hardware: MOVI-C® CONTROLLER (all performance classes)
Additionally required licenses	<ul style="list-style-type: none"> • MOVIRUN® flexible • MOVIKIT® Robotics
Additionally required software	<ul style="list-style-type: none"> • Available on USB stick on request • TRIPOD_RRRRR_M10 (part number 22681566)
Type code, part number	SMK1103-000, 23371889

6.9.4 MOVIKIT® Robotics add-on Circle



Functional description

The MOVIKIT® Robotics add-on Circle software module extends the range of functions of the MOVIKIT® Robotics software module by the option of circular interpolation. The circle segment can be parameterized in different ways:

- Circle center and angle
- Circle center and end point of the circle segment
- Intermediate point on the circle segment and end point of the circle segment
- Radius and angle
- Radius and end point of the circle segment

For more information, refer to the associated → [manual](#).

Project planning notes	
License type	Single license
Hardware requirements	The software module is compatible with the following hardware: MOVI-C® CONTROLLER (all performance classes)
Additionally required licenses	<ul style="list-style-type: none"> • MOVIRUN® flexible • MOVIKIT® Robotics
Type code, part number	SMK1107-000, 23371994

6.9.5 MOVIKIT® Robotics add-on ConveyorTracking



Functional description

The MOVIKIT® Robotics add-on ConveyorTracking software module extends the scope of functions of the MOVIKIT® Robotics software module by the option of interpolation in moving coordinate systems. Applications include e.g. removing parts from a conveyor belt and placing them in a static environment or the direct transfer of goods between several conveyor belts.

For more information, refer to the associated → [manual](#).

Project planning notes	
License type	Single license
Hardware requirements	The software module is compatible with the following hardware: MOVI-C® CONTROLLER (all performance classes)
Additionally required licenses	<ul style="list-style-type: none"> • MOVIRUN® flexible • MOVIKIT® Robotics
Type code, part number	SMK1110-000, 23372036

6.10 Category "SingleAxis"

The category "SingleAxis" includes all MOVIKIT® software modules with parameterizable functions and with a standardized process data interface. Unlike the category "MultiMotion", no programming knowledge is required here for startup and diagnostics.

6.10.1 MOVIKIT® Gearing



Functional description

The MOVIKIT® Gearing software module allows for implementing synchronous operation applications with a predefined fieldbus interface. In addition to the Gearing operating mode for synchronous applications, the software module offers all the basic operating modes known from the MOVIKIT® "Positioning" (→ 78) software module (jog mode, velocity control, positioning, referencing). With the MOVIKIT® Gearing software module, the inverter is operated interpolated in all operating modes. The MOVIKIT® Gearing software module also supports the following MOVIKIT® add-ons:

- "MOVIKIT® MultiMotion add-on PositionController" (→ 62)
- "MOVIKIT® MultiMotion add-on CombinedEncoderEvaluation" (→ 63)
- "MOVIKIT® Motion add-on AntiSway" (→ 46)

Overview of functions:

- Startup via graphical user interfaces of the MOVISUITE® engineering tool
- Dedicated parameter tree with all the parameters that are required for operation
- Provision of the following operating modes:
 - Jog mode
 - Velocity control
 - Positioning mode (relative/absolute)
 - Referencing mode
 - Synchronous operation
- Position and time-dependent engagement/disengagement mechanisms and offset processing
- Provision of an alignment function
- Diagnostic monitor for monitoring and controlling the axis
- Standardized process data interface

For more information, refer to the associated → [manual](#).

Project planning notes	
License type	Performance license
Hardware requirements	<p>The software module is compatible with the following hardware:</p> <ul style="list-style-type: none"> • MOVI-C® CONTROLLER (all performance classes) • MOVIDRIVE® modular (as an interpolating device) • MOVIDRIVE® system (as an interpolating device) • MOVIDRIVE® technology (as an interpolating device) <p>If you want to use Generation C devices such as MOVITRAC®, MOVIGEAR® or MOVIMOT®, contact SEW-EURODRIVE.</p>

Project planning notes	
Additionally required licenses	MOVIRUN® flexible
Type code, part number	<ul style="list-style-type: none"> • SMK1709-020, 23372877 • SMK1709-040, 23372885 • SMK1709-060, 23372893 • SMK1709-080, 23372907

6.10.2 MOVIKIT® Positioning



Functional description

The MOVIKIT® Positioning software module allows for implementing positioning applications with a predefined fieldbus interface. The software module mainly uses the basic functions of the application inverter in use by activating the respective function blocks (such as FCB 09 Position control) depending on the application. This means the scope of functions that can be used depends on the application inverter in use (for example encoder feedback available).

Overview of functions:

- Startup via graphical user interfaces of the MOVISUITE® engineering tool
- Provision of the following operating modes:
 - Jog mode
 - Velocity control
 - Positioning mode (relative/absolute)
 - Referencing mode
- Diagnostic monitor for monitoring and controlling the axis
- Standardized process data interface

For more information, refer to the associated → [manual](#).

Project planning notes	
License type	Included in the license for MOVIRUN® flexible
Hardware requirements	The software module is compatible with the following hardware: MOVI-C® CONTROLLER (all performance classes)
Additionally required licenses	MOVIRUN® flexible
Type code, part number	<ul style="list-style-type: none"> • SMR0001-020, 23371358 • SMR0001-040, 23371366 • SMR0001-060, 23371676 • SMR0001-080, 23371307

6.10.3 MOVIKIT® Velocity



Functional description

The MOVIKIT® Velocity software module allows for implementing applications with velocity control and a predefined fieldbus interface. The software module mainly uses the basic functions of the application inverter in use by activating the respective function blocks (such as FCB 09 Position control) depending on the application. This means the scope of functions that can be used depends on the application inverter in use (for example encoder feedback available).

Overview of functions:

- Startup via graphical user interfaces of the MOVISUITE® engineering tool
- Provision of the following operating modes:
 - Jog mode
 - Velocity control
 - Positioning mode (relative/absolute)
 - Referencing mode
- Diagnostic monitor for monitoring and controlling the axis
- Standardized process data interface

For more information, refer to the associated → [manual](#).

Project planning notes	
License type	Included in the license for MOVIRUN® flexible
Hardware requirements	The software module is compatible with the following hardware: MOVI-C® CONTROLLER (all performance classes)
Additionally required licenses	MOVIRUN® flexible
Type code, part number	<ul style="list-style-type: none"> • SMR0001-020, 23371358 • SMR0001-040, 23371366 • SMR0001-060, 23371676 • SMR0001-080, 23371307

6.10.4 MOVIKIT® Winder



Functional description

The MOVIKIT® Winder software module provides functions in a program library for implementing winding applications; these functions enable winding or unwinding of materials with constant tension or constant path speed.

In winding applications, different materials and mechanical conditions demand different winding technologies. The following standard methods are supported:

- Tension-determining winder
 - Torque control (optional with closed-loop tension control)
 - Closed-loop dancer position control
 - Closed-loop tension control via control of the setpoint speed through tension measurement
- Speed determined by winder with optional speed control

For more information, refer to the associated manual.

Project planning notes	
License type	Performance license
Hardware requirements	The software module is compatible with the following hardware: MOVI-C® CONTROLLER (all performance classes)
Additionally required licenses	MOVIRUN® flexible
Type code, part number	<ul style="list-style-type: none"> • SMK1710-020, 23373156 • SMK1710-040, 23373164 • SMK1710-060, 23373172 • SMK1710-080, 23373180

6.10.5 MOVIKIT® RotaryKnife



Functional description

The MOVIKIT® RotaryKnife software module allows for implementing electronic cam applications with the rotary knife function and a predefined fieldbus interface. In addition to the "Automatic" operating mode, the software module offers all basic operating modes known from the MOVIKIT® Positioning software module (jog mode, velocity control, positioning mode, referencing mode). The inverter is operated interpolated in all operating modes with the MOVIKIT® RotaryKnife software module.

Overview of functions:

- Startup via graphical user interfaces of the MOVISUITE® engineering tool
- Provision of the following operating modes:
 - Jog mode
 - Velocity control
 - Positioning mode (relative/absolute)
 - Referencing mode
 - Automatic mode
- Parameterization of the "rotary knife" function via process data
- Diagnostic monitor for monitoring and controlling the axis
- Standardized process data interface

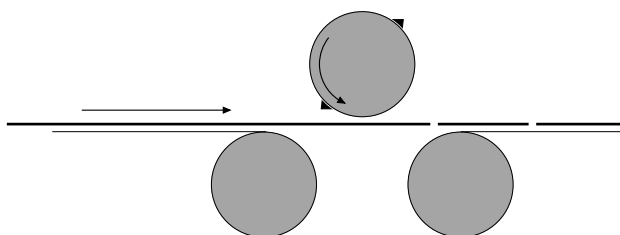

Project planning notes	
License type	Single license
Hardware requirements	The software module is compatible with the following hardware: MOVI-C® CONTROLLER (all performance classes)
Additionally required licenses	<ul style="list-style-type: none"> • MOVIRUN® flexible • MOVIKIT® MultiMotionCamming
Type code, part number	SMK1740-000, 23373326

6.10.6 MOVIKIT® FilmFeeder

**Functional description**

The MOVIKIT® FilmFeeder software module allows for implementing the film feeder function with print mark recognition and a predefined fieldbus interface. In addition to the "Automatic" operating mode, the software module offers all the basic operating modes known from the MOVIKIT® Positioning software module (jog mode, velocity control, positioning, referencing). With the MOVIKIT® FilmFeeder software module, the inverter is operated interpolated in all operating modes.

Overview of functions:

- Startup via graphical user interfaces of the MOVISUITE® engineering tool
- Provision of the following operating modes:
 - Jog mode
 - Velocity control
 - Positioning mode (relative/absolute)
 - Referencing mode
 - Automatic mode
- Parameterization of the "film feed with print mark recognition" function via process data
- Diagnostic monitor for monitoring and controlling the axis
- Standardized process data interface

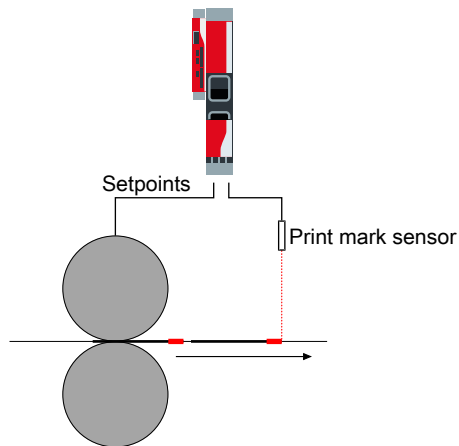

Project planning notes	
License type	Single license
Hardware requirements	The software module is compatible with the following hardware: MOVI-C® CONTROLLER (all performance classes)
Additionally required licenses	<ul style="list-style-type: none"> • MOVIRUN® flexible • MOVIKIT® MultiMotionGearing, MOVIKIT® Gearing or MOVIKIT® MultiMotionCamming

Project planning notes	
Type code, part number	SMK1720-000, 23373202

6.11 Category "StackerCrane"

The category "StackerCrane" includes MOVIKIT® software modules for implementing storage/retrieval systems.

6.11.1 MOVIKIT® StackerCrane effiDRIVE®



Functional description

The MOVIKIT® StackerCrane effiDRIVE® software module is used to operate storage/retrieval systems in an energy-efficient manner. Up to 25% of energy can be saved by optimized travel cycles of lifting and travel drives. The software module can be used for implementing storage/retrieval systems with up to 4 travel axes and up to 4 lifting axes. Both directions of movement require at least one external encoder each, or a connection to the companion structure must be ensured in a slip-free manner, for example by a gear rack. Target positions and dynamics parameters for the travel and lifting axes are specified by means of a user-friendly process data interface. The "MOVIKIT® StackerCrane MultiMotion" (→ 87) and "MOVIKIT® StackerCrane MultiAxisController" (→ 88) software modules are available for adding lower-level single axes or groups of axes. For more information, refer to the associated → [manual](#).

The MOVIKIT® MultiAxisController software module can also be used with only one lower-level axis. It increases the range of functions, as shown in the figure below.

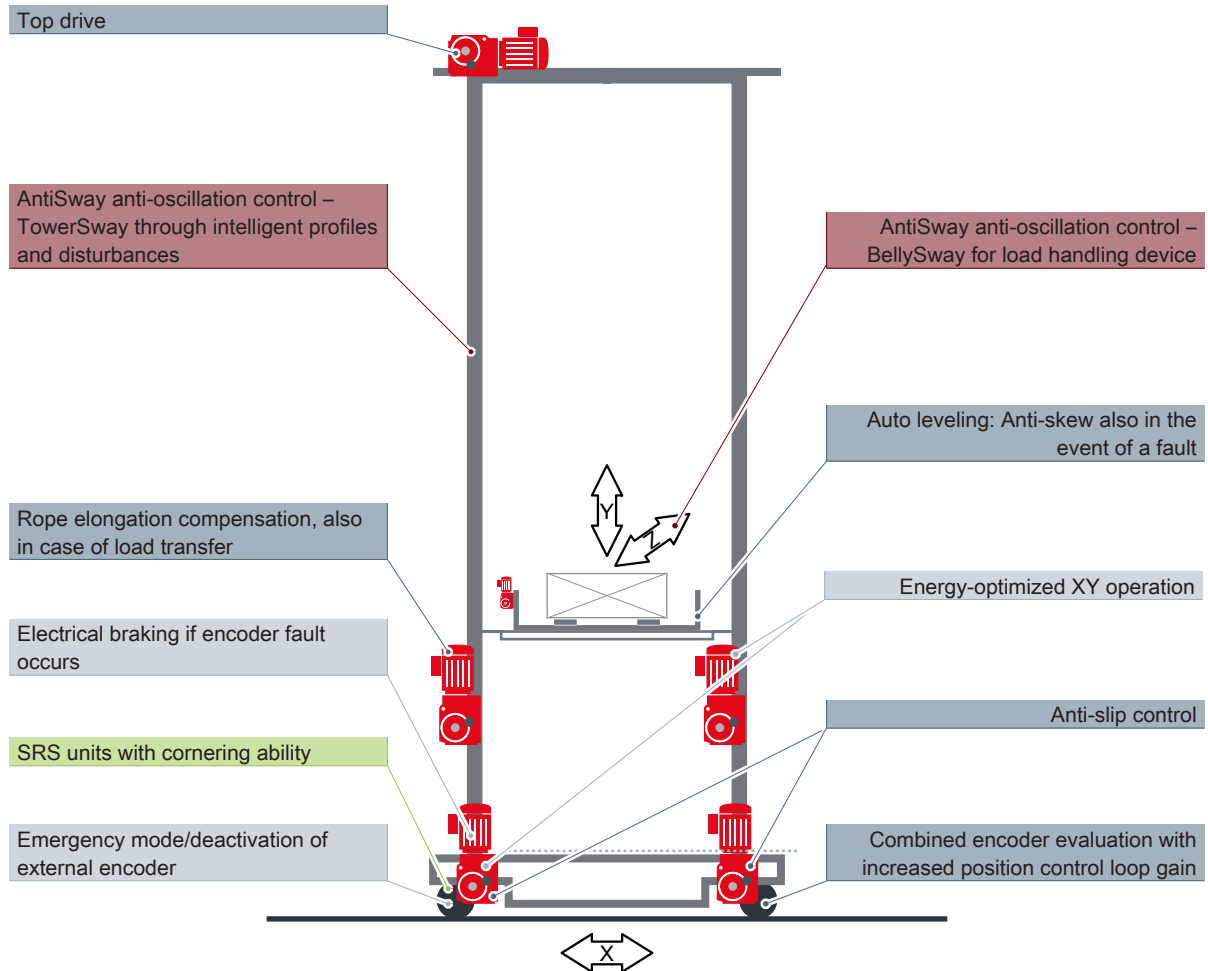

Range of functions of the MOVIKIT® StackerCrane effiDRIVE® in combination with:

- MultiMotion
- MultiAxisController
- Motion addon AntiSway
- MOVIKIT® Custom CurveDrive

The following tables provide an overview of which licenses are required and are available for which applications and functions. The MOVI-C® CONTROLLER on which the applications and functions are available is specified in each case (+/-).

MOVI-C® CONTROLLER

Function	License	Type code	UHX45A	UHX65A-R02
Operating system	MOVIRUN® flexible (UHX45A)	SMR0001-040	+	-
	MOVIRUN® flexible (UHX65A)	SMR0001-060	-	+

26876124/EN – 08/2021

Horizontal/vertical drive

Function	License	Type code	UHX45A	UHX65A-R02
<ul style="list-style-type: none"> Same interface with/without MultiAxisController XY energy optimization Emergency mode Override for nighttime operation or when the energy store is deactivated 	MOVIKIT® StackerCrane effiDRIVE®	SMK1301-000	+	+
<ul style="list-style-type: none"> Increased dynamic response Multiple axes in a single direction of travel Rope elongation compensation 	MOVIKIT® MultiAxisController Torque	SMK1201-000	+	+
<ul style="list-style-type: none"> 2 mechanically separated drives in a single direction of travel Anti-sway control with top drive 	MOVIKIT® MultiAxisController Skewing	SMK1202-000	+	+
<ul style="list-style-type: none"> Anti-sway control without top drive ("tower sway" application type) 	MOVIKIT® Motion add-on AntiSway (plus MultiAxisController)	SMK0008-000	-	+

Load handling device (LHD)

Function	License	Type code	UHX45A	UHX65A-R02
One axis	MOVIKIT® Positioning	-	+	+
Several axes	MOVIKIT® Gearing	SMK1709-060	+	+
Combi-telescope	MOVIKIT® Gearing	SMK1709-060	+	+
	MOVIKIT® CombiTelescope	SMK1305-000	+	+
"Belly sway" anti-sway application type	MOVIKIT® MultiAxisController Torque	SMK1201-000	+	+
	MOVIKIT® Motion add-on AntiSway	SMK0008-000	-	On request

6.11.2 MOVIKIT® StackerCrane MultiMotion



Functional description

The MOVIKIT® StackerCrane MultiMotion software module is used to operate a single axis in one direction of travel below a MOVIKIT® StackerCrane effiDRIVE® software module, see licensing example for "storage/retrieval systems" (→ 95).

For more information, refer to the associated → [manual](#).

Project planning notes	
License type	Included in the license for MOVIRUN® flexible
Hardware requirements	<p>The software module is compatible with the following hardware:</p> <ul style="list-style-type: none"> • From MOVI-C® CONTROLLER advanced UHX45A • MOVIDRIVE® modular (as an interpolating device) • MOVIDRIVE® system (as an interpolating device) • MOVIDRIVE® technology (as an interpolating device) <p>If you want to use Generation C devices such as MOVITRAC®, MOVIGEAR® or MOVIMOT®, contact SEW-EURODRIVE.</p>
Additionally required licenses	<ul style="list-style-type: none"> • MOVIRUN® flexible • MOVIKIT® StackerCrane effiDRIVE®
Type code, part number	<ul style="list-style-type: none"> • SMR0001-020, 23371358 • SMR0001-040, 23371366 • SMR0001-060, 23371676 • SMR0001-080, 23371307

6.11.3 MOVIKIT® StackerCrane MultiAxisController

**Functional description**

The MOVIKIT® StackerCrane MultiAxisController software module is used to control several axes together in one direction of travel below a MOVIKIT® StackerCrane effiDRIVE®. Single axes subordinate to the MOVIKIT® StackerCrane MultiAxisController require the MOVIKIT® StackerCrane MultiMotion software module, see licensing example for "storage/retrieval systems" (→ 95).

For more information, refer to the associated → [manual](#).

Project planning notes	
License type	Included in the MOVIKIT® MultiAxisController license
<2	<p>The software module is compatible with the following hardware:</p> <ul style="list-style-type: none"> • From MOVI-C® CONTROLLER advanced UHX45A • MOVIDRIVE® modular (as an interpolating device) • MOVIDRIVE® system (as an interpolating device) • MOVIDRIVE® technology (as an interpolating device) <p>If you want to use Generation C devices such as MOVITRAC®, MOVIGEAR® or MOVIMOT®, contact SEW-EURODRIVE.</p> <p>Make sure that the cycle time on the MOVI-C® CONTROLLER and on the inverters is set to ≤2 ms. When using the MOVIKIT® add-on AntiSway software module, the cycle time must be set to <2 ms. Otherwise, contact SEW-EURODRIVE.</p>
Additionally required licenses	<ul style="list-style-type: none"> • MOVIRUN® flexible • MOVIKIT® StackerCrane effiDRIVE®
Type code, part number	<ul style="list-style-type: none"> • SMR0001-020, 23371358 • SMR0001-040, 23371366 • SMR0001-060, 23371676 • SMR0001-080, 23371307

6.12 Category "Visualization"

The category "Visualization" comprises MOVIKIT® software modules that support the graphic display of data of the MOVI-C® CONTROLLER.

6.12.1 MOVIKIT® Visualization basic



Functional description

The MOVIKIT® Visualization basic software module is required to equip the MOVI-C® CONTROLLER progressive UHX65A with a graphical user interface (visualization). For this purpose, the software module is installed on the Windows section (OMW CFast memory card) of the MOVI-C® CONTROLLER.

Visualization means the graphical representation of the data of the MOVI-C® CONTROLLER. The local display port interface can be used for display or a remote browser panel for web visualization. For more information, refer to the associated → [manual](#).

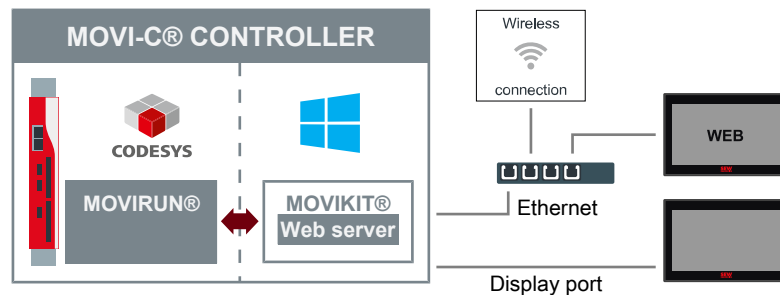

Project planning notes	
License type	Single license
Hardware requirements	The software module is compatible with the following hardware: <ul style="list-style-type: none"> • MOVI-C® CONTROLLER progressive UHX65A-R04 • OMW CFast memory card with Windows operating system
Type code, part number	SSE0001-000, 23372494

6.12.2 MOVIKIT® Visualization flexible

**Functional description**

The MOVIKIT® Visualization flexible software module is required to equip a Windows device with visualization. The software module is installed on this device for this purpose. By means of visualization, the data of a MOVI-C® CONTROLLER is displayed on a remote HMI device. The display port interface of the Windows device can be used for display or a browser panel can be used for web visualization. For more information, refer to the associated → [manual](#).

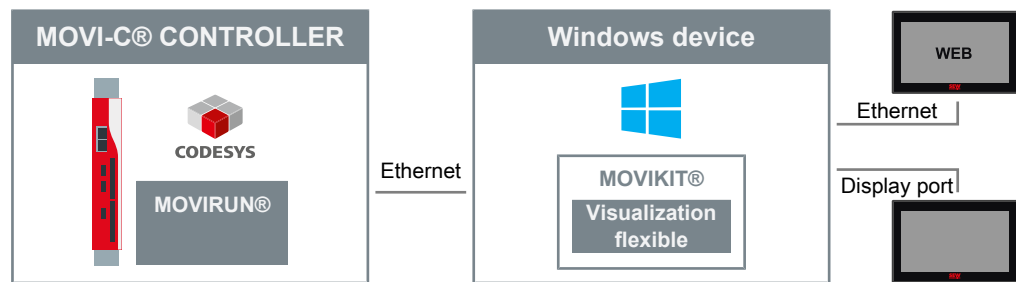

Project planning notes	
License type	Single license
Hardware requirements	Windows 10
Type code, part number	SSE0002-000, 23372508

6.12.3 MOVIKIT® Visualization multi

Functional description

The MOVIKIT® Visualization multi software module is required to equip a Windows device with visualization. The software module is installed on this device for this purpose. By means of visualization, the data of one or more MOVI-C® CONTROLLERS is displayed on a remote HMI device. The display port interface of the Windows device can be used for display or a browser panel can be used for web visualization. For more information, refer to the associated → [manual](#).

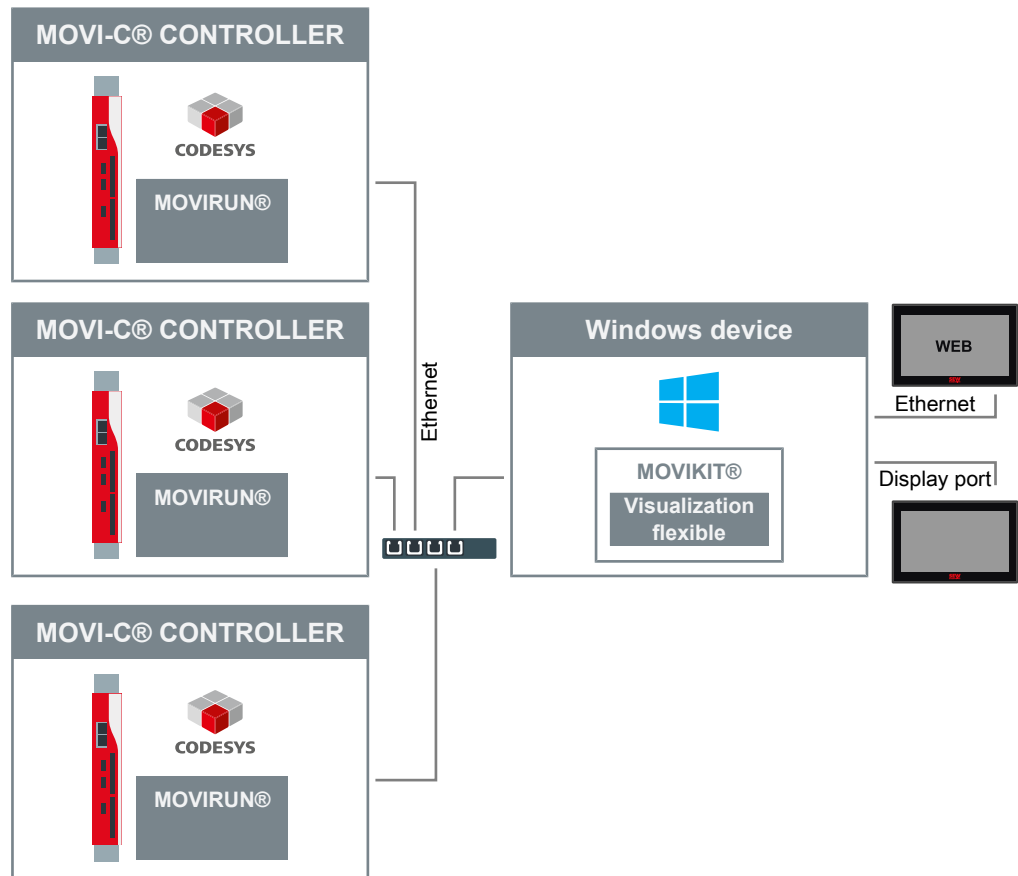

Project planning notes	
License type	Single license
Hardware requirements	Windows 10
Type code	SSE0003-000, 23372516

6.12.4 MOVIKIT® Web Visualization

**Functional description**

The MOVIKIT® Web Visualization software module enables web-based visualization based on open standards, e.g. HTML5. A local CODESYS web server on the MOVI-C® CONTROLLER provides distributed visualization on several devices; access is via a web browser. Thanks to HTML5, current smartphones and tablet computers can also be used as HMI devices. For more information, refer to the associated manual.

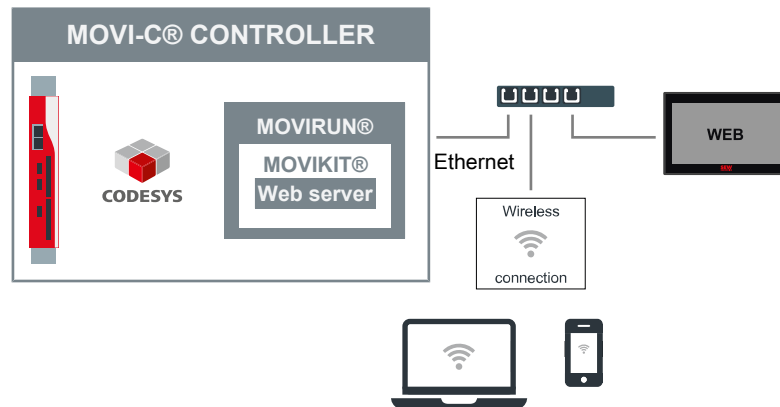
**Project planning notes**

License type	Performance license
Hardware requirements	<p>The software module is compatible with the following hardware:</p> <ul style="list-style-type: none"> • MOVI-C® CONTROLLER standard UHX25A • MOVI-C® CONTROLLER advanced UHX45A • MOVI-C® CONTROLLER progressive UHX65A
Type code, part number	<ul style="list-style-type: none"> • SMK1504-020, 23373059 • SMK1504-040, 23373067 • SMK1504-060, 23373075

7 Example applications with licensing

7.1 Gantry crane (MOVIKIT® MultiAxisController)

The following example includes all the licenses available from the "MultiAxisController" (→ 48) category of MOVIKIT® software modules.

A gantry crane is implemented with 2 drives on "SideA" of the X-axis and 4 drives on its "SideB". The following licenses are required:

License	Number	Type code
MOVIRUN® flexible	1	SMR0001-080
MOVIKIT® MultiAxisController Skewing	1	SMK1202-000
MOVIKIT® MultiAxisController add-on Cascading	1	SMK1205-000
MOVIKIT® MultiAxisController Torque	2	SMK1201-000
MOVIKIT® MultiAxisController add-on FourAxes	1	SMK1204-000

The following illustration shows the structure of the licensing:

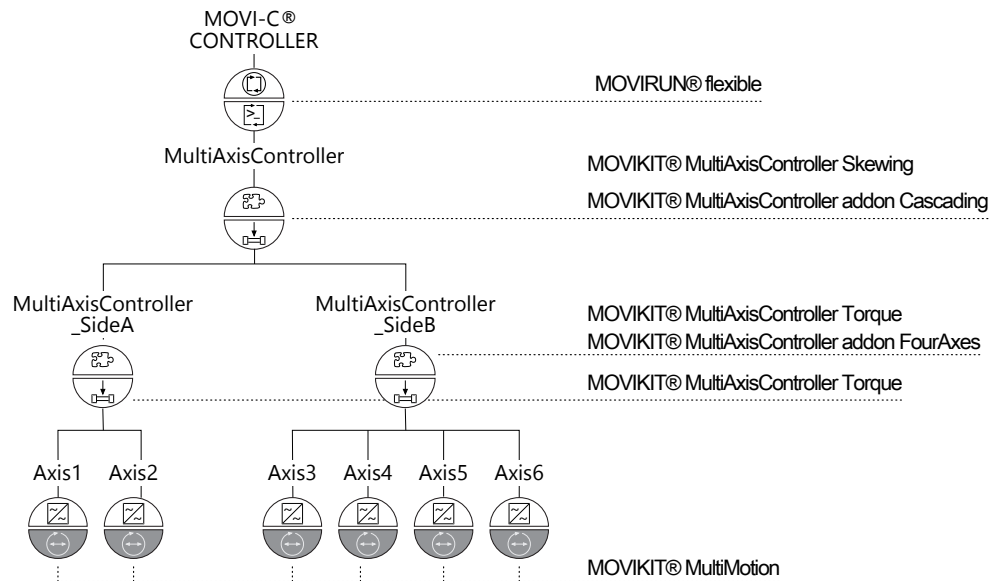

36028822476277387

7 Example applications with licensing

Robot (MOVIKIT® Robotics)

7.2 Robot (MOVIKIT® Robotics)

The following example includes licenses from the "Robotics" (→ 70) category of MOVIKIT® software modules.

A robot of the type "tripod" is implemented for example for pick and place applications. The following licenses are required:

License	Number	Type code
MOVIRUN® flexible	1	SMR0001-080
MOVIKIT® Robotics	1	SMK1101-000
MOVIKIT® Robotics add-on MediumModels	1	SMK1102-000

The following illustration shows the structure of the licensing:

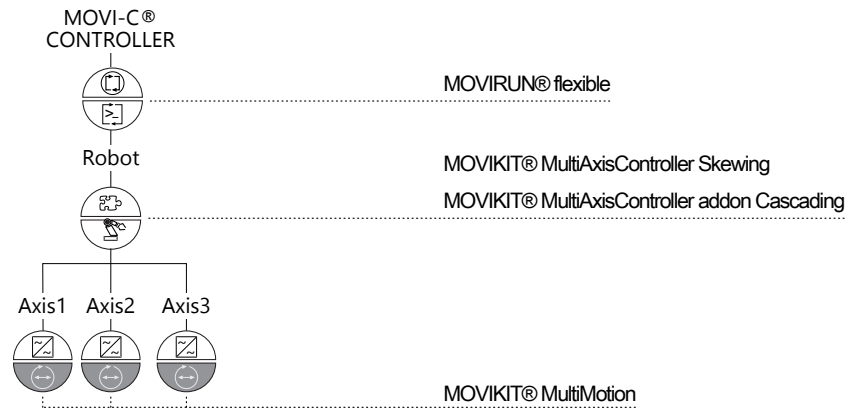

18014428925926027

7.3 Storage/retrieval system (MOVIKIT® StackerCrane effiDRIVE®)

The following examples include licenses from the "StackerCrane" (→ 84) category of the MOVIKIT® software modules.

For more information, refer to the associated → manual.

7.3.1 Rigid, low pallet stacker crane

A storage/retrieval system with 1 drive axis each in travel and lift directions is implemented. The following licenses are required:

License	Number	Type code
MOVIRUN® flexible	1	SMR0001-080
MOVIKIT® StackerCrane effiDRIVE®	1	SMK1301-000

The following illustration shows the structure of the licensing:

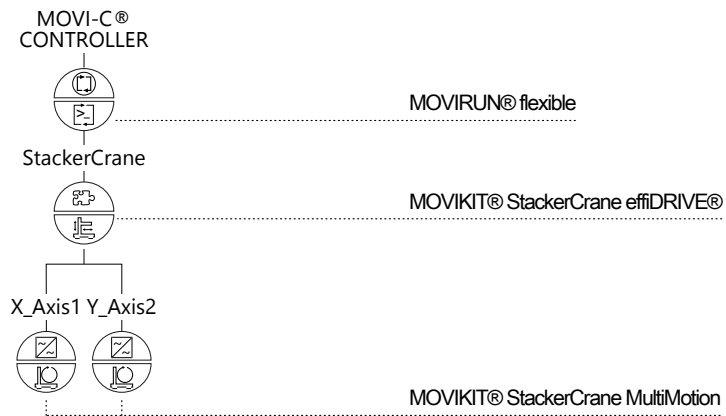

35301540235

7.3.2 Rigid pallet stacker crane with shuttle (without telescope)

A storage/retrieval system with 1 drive axis in the direction of travel and 2 drive axes in the direction of lift is implemented. The following licenses are required:

License	Number	Type code
MOVIRUN® flexible	1	SMR0001-080
MOVIKIT® StackerCrane effiDRIVE®	1	SMK1301-000
MOVIKIT® MultiAxisController Skewing	1	SMK1202-000

The following illustration shows the structure of the licensing:

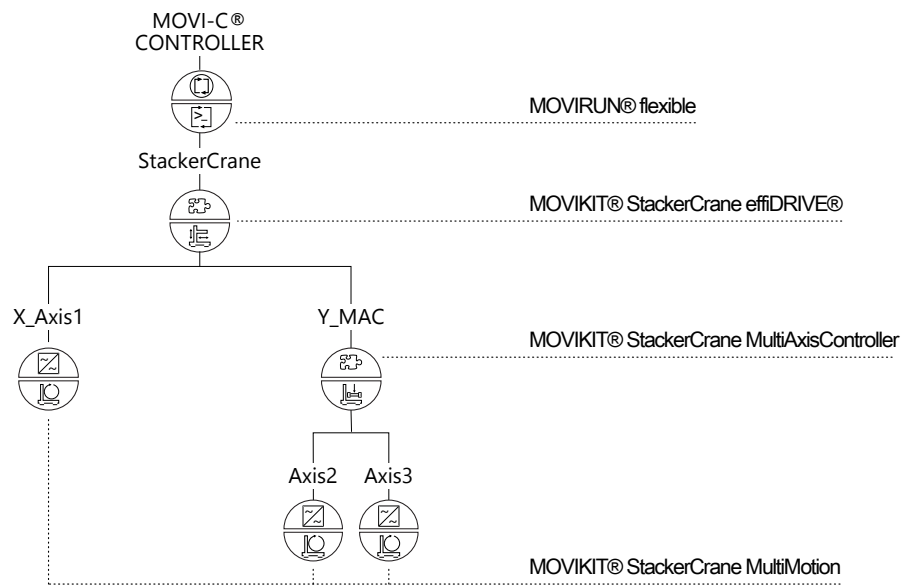

9007232871384203

7.3.3 High heavy-duty pallet warehouse or high lightweight box warehouse susceptible to vibration

A storage/retrieval system with one drive axis in the direction of travel and 2 drive axes in the direction of lift is implemented. The following licenses are required:

License	Number	Type code
MOVIRUN® flexible	1	SMR0001-080
MOVIKIT® StackerCrane effiDRIVE®	1	SMK1301-000
MOVIKIT® MultiAxisController Torque	1	SMK1201-000
MOVIKIT® MultiAxisController Skewing	1	SMK1202-000
MOVIKIT® Motion add-on AntiSway	1	SMK0008-000

The following illustration shows the structure of the licensing:

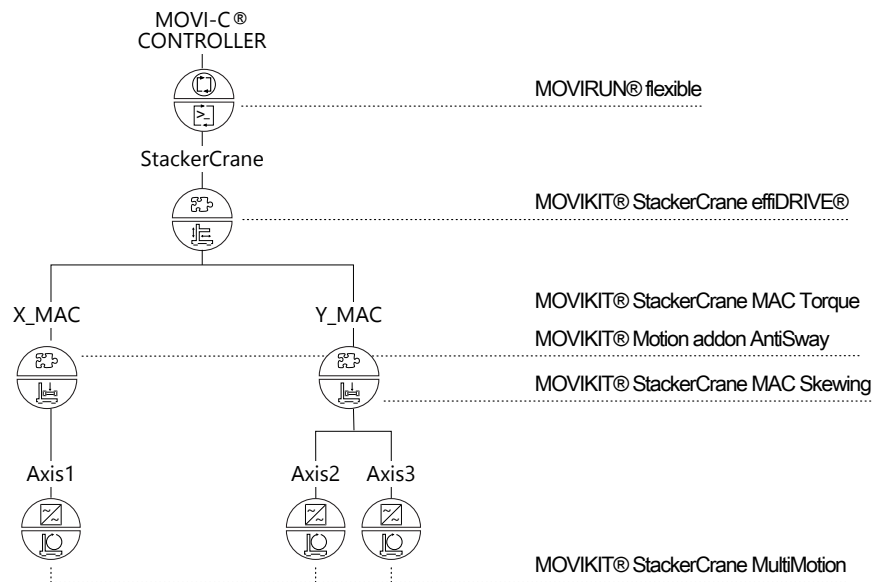

27021628180673931

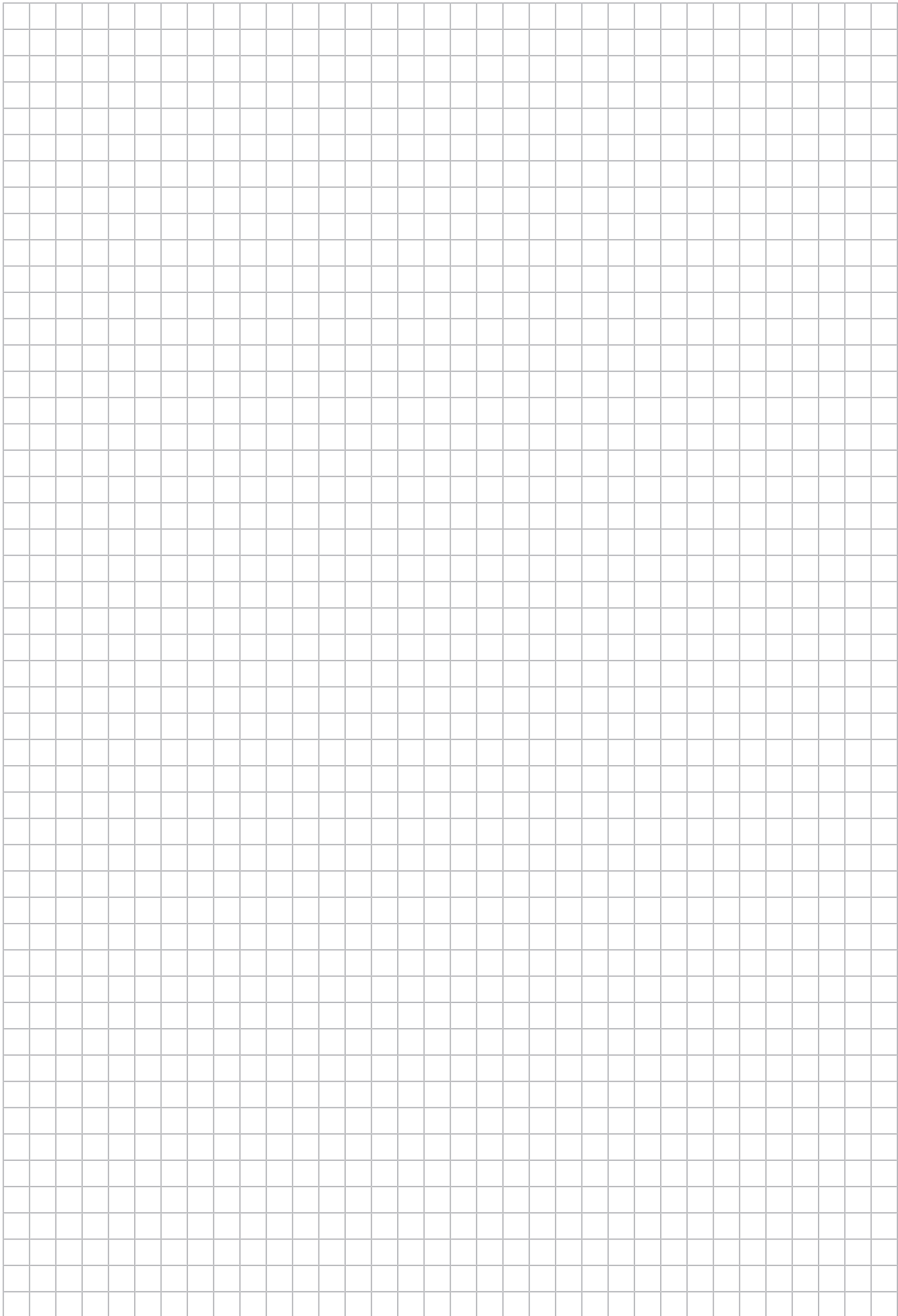

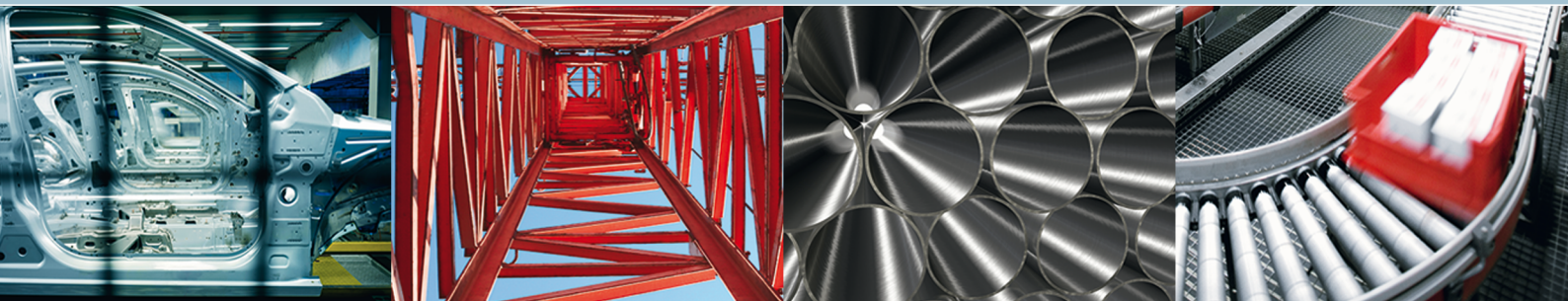
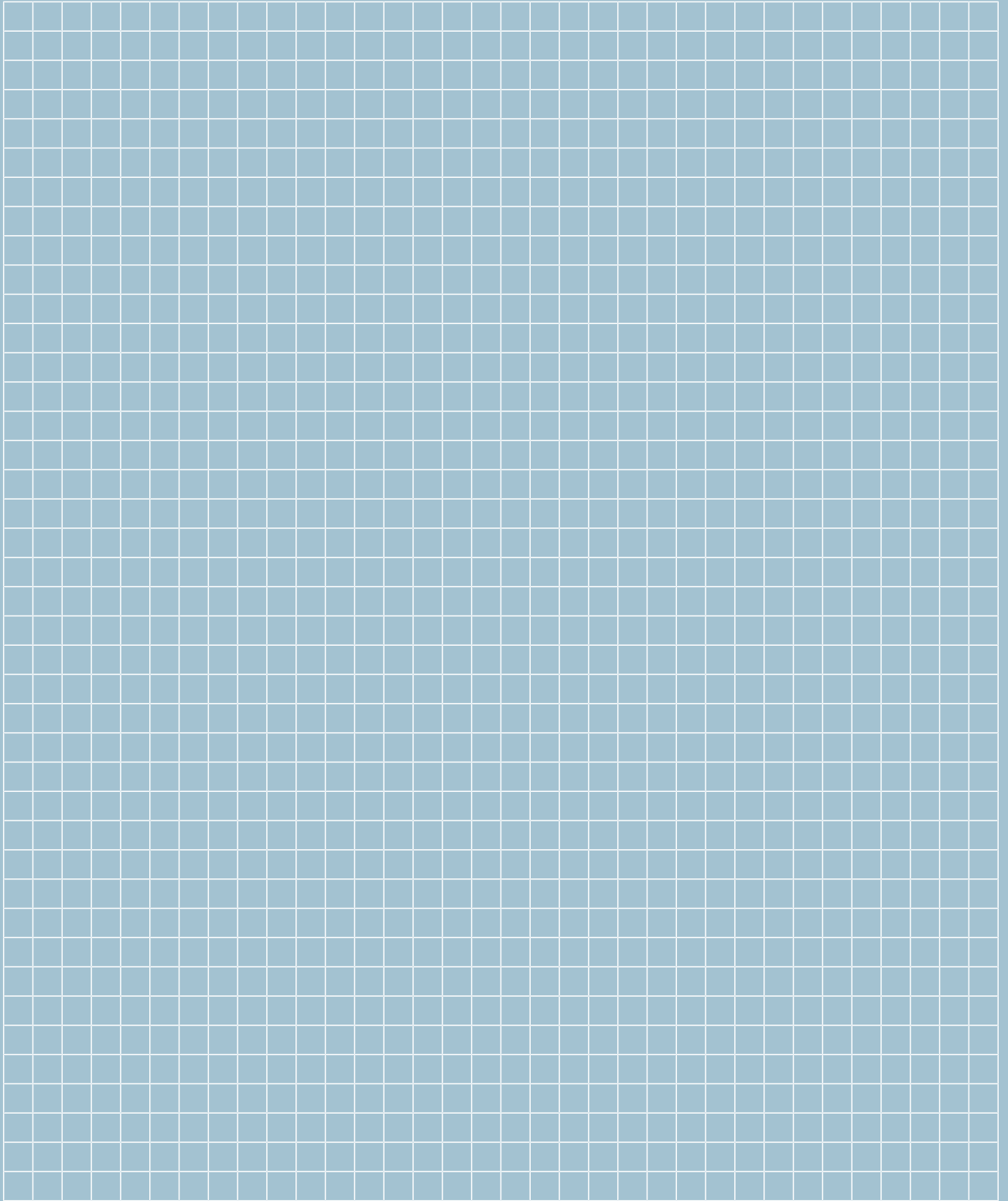

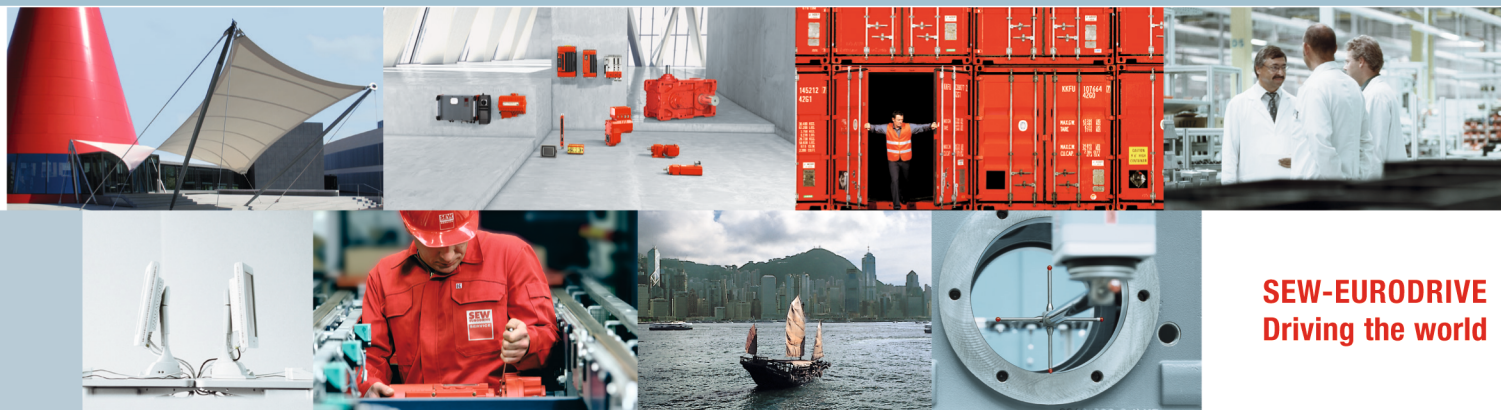

SEW-EURODRIVE
Driving the world

SEW
EURODRIVE

SEW-EURODRIVE GmbH & Co KG
Ernst-Blickle-Str. 42
76646 BRUCHSAL
GERMANY
Tel. +49 7251 75-0
Fax +49 7251 75-1970
sew@sew-eurodrive.com
→ www.sew-eurodrive.com